

CATALOG | 2022



LOUIS TELLIER

RIEN NE REMPLACE LE FAIT MAIN



www.louistellier.fr





LOUIS TELLIER

RIEN NE REMPLACE LE FAIT MAIN

1887

This story starts two years before the construction of the Eiffel Tower. Paris was becoming the centre for world creation. French gastronomy had exploded forth, and had excited the curiosity of gourmets and chefs from around the world.

Increasingly sophisticated desserts became the unmissable gourmet symbols of special occasions. A visionary entrepreneur, ETIENNE GOBEL, bet on the fact that the craze for patisserie was only just beginning, and he launched into making cake moulds from copper and tinplate. Success was immediate and international. Etienne Gobel soon found himself hemmed by his premises in Paris, so he set up his factory in Touraine, where it has been ever since and where tradition is maintained.

1947

Sixty years later, France was in the throes of reconstruction. People found vegetables on their plates once again, especially the potato. Established as one of the pearls of French gastronomy in the nineteenth century, its return had been awaited by restaurateurs.

One of them asked a mechanic friend to design a device to make it easy to prepare purée. LOUIS TELLIER took up the challenge and invented the world's first professional food mill – a kitchen revolution! An inventor of genius, the former seafarer and veteran of the First World War would multiply achievements in his factory in the suburbs of Paris; the factory remains at the cutting edge of innovation.

A year earlier and under the same circumstances, the hand-powered steel vegetable cutter was invented in Thonon les Bains, on the banks of Lake Léman: the Bron mandoline was born, and would come into use in leading professional kitchens around the world. In over seven decades, the BRON factory would see the advent of several leading inventions – and will specialize in the Convivial appliances with in particular the traditional Alpage® and Brézière® raclette appliances.

TODAY

Now called LOUIS TELLIER, the group continues to play a part in the great history of French cuisine through its innovations and two iconic brands:

LOUIS TELLIER for equipment for food preparation and sharing food, GOBEL for baking utensils and bakeware.

Present in more than ninety countries, these brands accompany, as they have always made, the pleasure of handmade.



LOUIS TELLIER

RIEN NE REMPLACE LE FAIT MAIN

LOUIS TELLIER IN FIGURES



OVER 100 COLLABORATORS



OVER 135 YEARS' EXPERTISE



2 FACTORIES IN FRANCE

Labeled EPV
« Entreprise du Patrimoine Vivant »
(Living Heritage Company)



1 AFTER SALES SERVICE

Provision of 1 500 spare parts



1 LOGISTICS SITE

Centralised at JOUÉ-LÈS-TOURS



OVER 3 500 REFERENCES



1 PRO ACCESS PORTAL

www.louistellier.fr



1 SHOWROOM / TRAINING CENTRE

In JOUÉ-LÈS-TOURS



EXPORTED TO OVER 90 COUNTRIES AROUND THE WORLD



1 CANADIAN / US SUBSIDIARY

Office and logistics in BOUCHERVILLE (QUÉBEC)



LOUIS TELLIER

RIEN NE REMPLACE LE FAIT MAIN

2 PRODUCTION WORKSHOPS 3 AREAS OF EXPERTISE

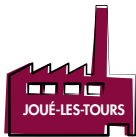
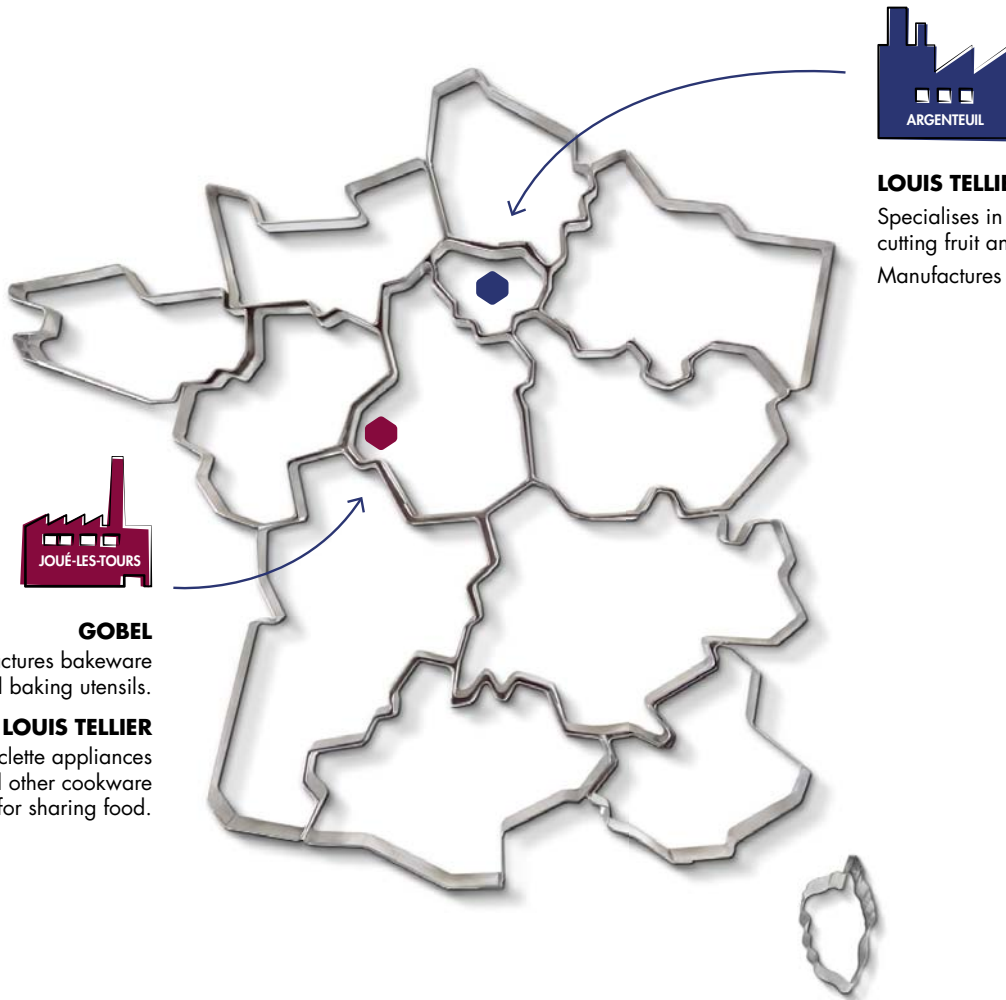

GOBEL

Manufactures bakeware and baking utensils.

LOUIS TELLIER

Raclette appliances and other cookware for sharing food.



LOUIS TELLIER

Specialises in equipment for cutting fruit and vegetables.
Manufactures food mills.



Groupe Louis Tellier's two production sites have the EPV (Living Heritage Company) label. This label is a mark of recognition awarded by the French government to French companies demonstrating excellent craftsmanship and industrial expertise.



The main products for cutting fresh fruit and vegetables made in the LOUIS TELLIER workshops are NF certified. Awarded by an independent, impartial body, the NF mark certifies compliance of products or services with relevant national, European and international normative documents. These include standards supplemented, where appropriate, by technical specifications reinforcing the quality level of the certification.



Groupe LOUIS TELLIER belongs to SYNEG, an organisation that brings together and represents catering equipment manufacturers. Members of SYNEG are carefully chosen based on strict criteria. They adhere to an environmentally and socially responsible approach.



Groupe LOUIS TELLIER is also a member of UNITAM, an organisation bringing together French manufacturers of quality catering equipment.



LOUIS TELLIER
RIEN NE REMPLACE LE FAIT MAIN

FOOD PREPARATION



LOUIS TELLIER is undoubtedly the food prep specialist, with a wide range of creative, innovative and productive equipment adapted to the needs of professional kitchens, including institutional catering services, traditional restaurants and trades within the food industry.

It offers more than **300 innovative solutions for cutting all forms of fruit and vegetables**, some of which have become iconic tools.



A wide range of professional, effective manual and electric can openers to improve productivity on a daily basis. From school kitchens to retirement homes, via community kitchens and hospitals, our NF-certified can openers perfectly meet professional hygiene standards.

A complete range of reliable and precise measuring equipment. Mechanical or electric and waterproof, our scales cover all needs and our thermometers, all technologies (including infrared and probe).



LOUIS TELLIER continues to innovate and expand its range of cooking utensils, with a commitment to providing the best solutions to meet the technical requirements of each use and make each task easier with precision and respect for the ingredients.

LOUIS TELLIER IS COMMITTED TO PRODUCING AND PROVIDING UTENSILS
USING THE BEST QUALITY, LONG-LASTING, SAFE MATERIALS.



LOUIS TELLIER

RIEN NE REMPLACE LE FAIT MAIN

SHARING FOOD



LOUIS TELLIER also offers a range of professional quality appliances for sharing food for indoor or outdoor use, depending on the equipment or speciality.



**BRASERO –
TABLETOP BBQ**

A high-quality, functional and professional tabletop charcoal barbecue that brings people together.



Brezières

RACLETTE

LOUIS TELLIER designs and distributes a complete range of raclette appliances in the pure alpine tradition.

Three types of appliances depending on the size of cheese chosen (¼ wheel, ½ wheel or thin slices):

Brezière (¼ wheel) or **Alpage** (½ wheel) are available in three versions:

- Original: textured bronze for a traditional style
- Basalte: textured black for a modern style
- Inox: with solid beech handles for a chic, classic style



Alpage

4-pan raclette appliance
(sliced cheese)

- All stainless steel, this professional quality appliance is hard-wearing and durable with a plug enabling you to connect several appliances.



**GRILL STONE WITH
OR WITHOUT STAND**

Natural soapstone to be heated in the oven (300°C).



PLANCHETTAS

Ceramic plate with (alcohol gel) burners.



COLD SMOKER

For fish, vegetables, shellfish, meat and more. With or without resistance.

FRANCE 1887

GOBEL®

rien ne remplace  le fait main

BAKEWARE AND BAKING UTENSILS



For 135 years, GOBEL has been making bakeware and baking utensils and selling them to catering professionals and prestigious specialised shops in over 90 different countries.

GOBEL covers all the needs of professionals in the baking industry with one commitment: provide a solution for each creation, recipe or speciality with respect for the ingredients by using high-quality, long-lasting and safe materials.

BAKEWARE

GOBEL tin plate, non-stick and Obsidian cake tins, pastry sheets and baking pans are all made at our site in Joué-lès-Tours (Indre-et-Loire).



Tin plate: this eco-friendly 100% recyclable, safe material is highly conductive! Guaranteeing an unequalled taste, our tin plate moulds are renowned for creating crisp pastry that is golden on the outside and soft on the inside.

Non-stick: professional quality, PFOA-free, with a double-layer coating, this material is much higher performing than single-layer materials and is easy release. Its upper layer contains mica, making it highly resistant to abrasion.

Obsidian: a technological innovation, Obsidian has a new, even better coating. It has excellent non-stick properties, strengthened by ceramic for more resistance and a 10-year non-stick guarantee.

Stainless steel: GOBEL offers a wide range of thick, solid, hard-wearing and easy-to-clean, "Made in France" stainless steel products, including rings, tart rings, cake frames, baking sheets, cutters, fluted cutters and icing tips.

PASTRY SHEETS

GOBEL pastry sheets are vital for oven baking and are available in stainless steel, aluminium and aluminium with a non-stick coating. They can also be used when preparing or storing food in refrigerators and warming drawers.

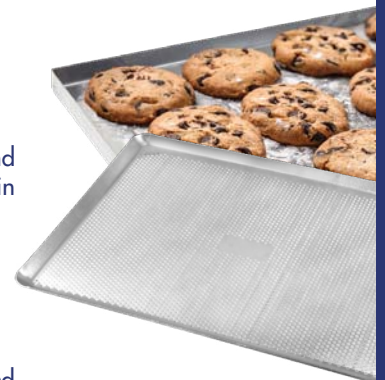

UTENSILS

GOBEL also offers a wide range of baking utensils and accessories, including mixing bowls, bowls, pastry mats, baking mats, whipped cream dispensers, piping bags, rolling pins, spatulas and pastry brushes.



RECOMMENDATIONS FOR USE

CARE INSTRUCTIONS

YES 	NO 	STAINLESS STEEL	NON-STICK	TIN	ALUMINIUM	ALUMINIUM with non-stick coating

BAKING INSTRUCTIONS

YES 	NO 	STAINLESS STEEL	NON-STICK	TIN	ALUMINIUM	ALUMINIUM with non-stick coating
		300°C 570°F	250°C 480°F	250°C 480°F	250°C 480°F	250°C 480°F

CATALOGUE KEY

This new catalogue format brings together main technical information to give you accurate answers to your questions and to your clients' needs. Set out below are the reading key to the pictograms.

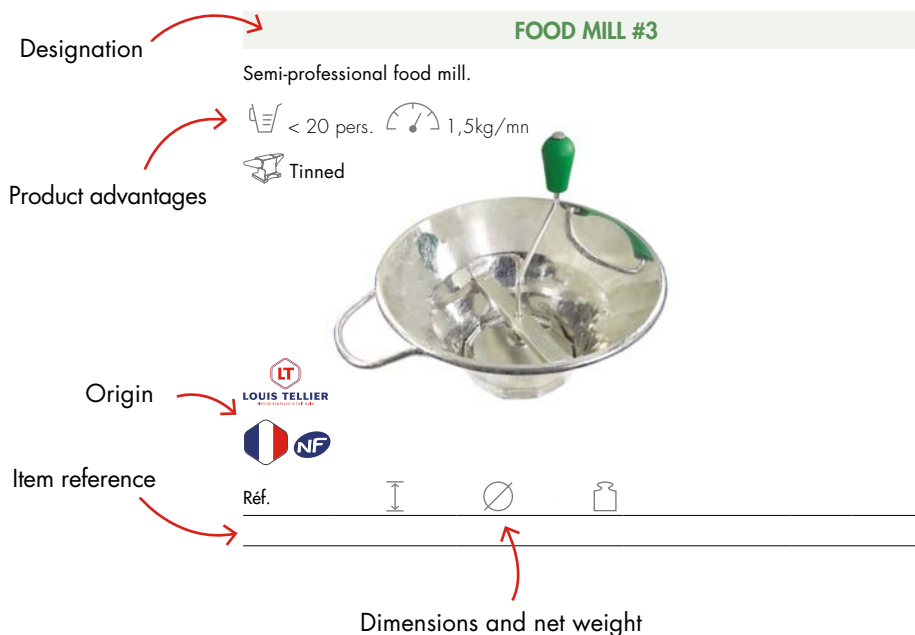

KEY TO PICTOGRAMS USED



New catalogue item



Best-selling item in a range

ORIGIN



FRANCE



JAPAN

CERTIFICATIONS AND NORMS



NF HYGIÈNE ALIMENTAIRE

The NF mark is a sign of acknowledgement that is the result of a voluntary approach by professionals dedicated to making genuine commitments to their clients. It offers a guarantee of quality and safety in relation to the products that display it. The "NF Hygiène Alimentaire" mark issued by AFAQ AFNOR CERTIFICATION, 93571 La Plaine Saint-Denis Cedex, certifies compliance with regulation NF 031, which covers suitability for cleaning.



NSF INTERNATIONAL

NSF International (National Sanitation Foundation) is an independent public health standard from the United States. It organizes and develops standards, product certification, testing, auditing, environmental education and environmental and public health risk management services. The Logo on the data sheet or packaging serves as information on whether the product is labeled or not, the product does not receive a specific reference, only the NSF list serves as proof with the Name and/or Reference of the manufacturer.



IP WATERTIGHTNESS
Water and dust.



HACCP

Hazard Analysis Critical Control Point, is a work method for mastering the health security of foodstuffs and guaranteeing hygiene in the kitchen. The HACCP approach is taken into account when products are developed, especially their suitability for cleaning.

FEATURES

Length in cm

Height in cm

Thickness in mm

Width in cm

Capacity

Equipment included

Material

Specific features

Diameter in cm

Net weight in kg or g

Display available

Productivity / debit

Linked products

Dedicated to electrical and electronic appliances

Power

AC adaptor

Type of batteries and number supplied

Spécifiques aux instruments de poids et mesure

Temperature range

Quantity to weight

Accuracy

SUMMARY

CULINARY PREPARATION 14

FRUITS AND VEGETABLES	17
MEAT AND CHARCUTERIE	64
PASTA AND PIZZA	69
TERRINES AND CHEESES	77
EGGS	81
BREAD, SANDWICHES AND TORTILLAS	83
CUTTING ACCESSORIES	85
KITCHEN TOOLS	91
CAN OPENERS	97
SCALES & THERMOMETERS	107

COOKING/TEMPERATURE HOLD 116

COOKING	119
---------	-----

COFFEE/BAR/RECEPTION 124

JUICE	127
BAR ACCESSORIES	129
BREAKFAST/RECEPTION	133

TABLE SERVICE AND BUFFET 136

TABLE ACCESSORIES	139
BUFFET ACCESSORIES	141
SERVING ACCESSORIES	143
ORDERS ACCESSORIES	144

PRESERVATION 146

VACUUM SEALING MACHINES	149
RULERS & DISPENSERS	150
DEHYDRATORS	151
CONDIMENT DISPENSERS	153

HYGIENE 158

DISPENSERS	159
------------	-----

SHARING 162

RACLETTE AND FONDUES	165
BRASEROS AND PLANCHETTAS	171
SKEWERS	174
FOOD SMOKERS	176

NON-STICK 178

BAKING TRAYS	181
BREAD MOULDS AND BAKING TRAYS	184
PIZZA MOULDS AND OVEN ROASTING PAN	186
FOLDING LOAF CAKE MOULD	187
CAKE MOULDS	188
BRIOCHE MOULDS	189
ROUND PLAIN TART MOULDS	191
ROUND CAKES & MILLASSON MOULDS	198
BAKING SHEETS	200
SAVARIN, CHARLOTTE AND THEME MOULDS	201
INDIVIDUAL BITES & CAKES	204
RECIPES & KIT PACKS	207
PROFESSIONAL MULTI BAKING TRAYS	209

OBSDIAN NON-STICK 212

OBSDIAN BAKING SHEETS AND MOULDS	215
----------------------------------	-----

TIN 220

BAKING/BREAD/PIZZA TRAYS	223
FOLDING LOAF CAKE MOULDS	226
CAKE MOULDS	227
BRIOCHE MOULDS	228
ROUND PLAIN TART MOULDS	231
ROUND CAKES AND MILLASSON MOULDS	235
BAKING SHEET AND THEME MOULDS	237
INDIVIDUAL BITES & CAKES	239

ORIGINE 242

BIODEGRADABLE ORIGINE MOULDS	243
------------------------------	-----

STAINLESS STEEL **244**

EDGED TART & CUSTARD PIE RINGS	246
EDGELESS TART & CUSTARD PIE RINGS	249
STAINLESS STEEL SHAPES	252
HEAVY CAKE FRAMES	261
GUTTERS & YULE-LOG MOULDS	263

PASTRY SHEETS **264**

PASTRY SHEETS	267
---------------	-----

BAKING TOOLS **270**

MIXING BOWLS	272
BAKING MATS AND ROLLING PINS	273
WHISKS, SPATULAS, SPOONS AND BRUSHES	275
PASTRY PIPING BAGS AND TUBES	278
WHIPPED CREAM DISPENSERS AND CHARGERS	283
DOUGH CUTTER & SCRAPER	284
PASTRY CUTTER	286
SIEVE AND HOLE SHAKER, DOSING TOOLS AND TINNED SIEVE	289
OTHER TOOLS	293

DISPLAY AND SALES SUPPORT **296**

DISPLAY, CDU, RECIPE REFILL AND POSTER	298
--	-----

CONTACT

Louis Tellier SAS

+33 (0)1 34 11 38 38

info@louistellier.fr

Siège : 116 Quai de Bezons
95100 Argenteuil – France

Showroom : 5 rue Debrou - ZI de la Gare
37300 Joué-lès-Tours – France

WEB

Suivez nos actualités



www.louistellier.fr

Sur LouisTellier.fr accédez aux vues éclatées, notices et fiches techniques en recherchant par la référence de l'article.

VIDÉOS

Flashez le QR CODE* à l'aide de votre smartphone ou de votre tablette : la vidéo s'ouvre directement.

Accédez également à l'ensemble de nos vidéos sur la chaîne Youtube Groupe Louis Tellier.

* Vous pouvez télécharger une application gratuite dédiée (flashcode, QR Code Reader, QR Code...)

Faites le test ici !





CULINARY PREPARATION

FRUITS AND VEGETABLES

17

- Food mills 17
- Masher and coulis 20
- Mandolines 23
- French-fries cutters 27
- Tomatoes and citrus slicers 33
- Lettuce cutters 34
- Vegetable & fresh herbs slicers 37
- Peelers 45
- Apple and citrus cutters 53
- Exotic fruits cutters 57
- Fruits and vegetables carving 61

MEAT AND CHARCUTERIE

64

- Grinders and stuffers 64

PASTA AND PIZZA

69

- Pasta machines and accessories 69
- Pizza accessories 75

TERRINES AND CHEESES

77

EGGS

81

BREAD, SANDWICHES AND TORTILLAS

83

CUTTING ACCESSORIES

85

- Chopping boards 85
- Anti-cut gloves, sharpeners, scissors 90

KITCHEN TOOLS

91

- Beechwood spatulas and spoons 91
- Composite spatulas and spoons 92
- Stainless steel 93

CAN OPENERS

97

- Electrical 97
- Manuals 101

SCALES & THERMOMETERS

107

- Scales 107
- Thermometers 111

PROFESSIONAL FOOD MILL NO. 5

LOUIS TELLIER
BIEN NE REMPLACE LE FAIT MAINT

Sieves Ø 1
and 1.5 mm:
for sauces and
coulis.



Sieves Ø 2 and 3 mm:
for mashed potatoes,
soups and compotes.



Sieves Ø 4 mm:
for fish soups and stringy
vegetables as leeks and
spinach.



In 1947, Louis Tellier revolutionised the world of cooking by creating the first professional food mill. The LT grinding mill was so on a runaway success with restaurateurs. In a smaller-sized model, the LT mill brought purees, soups, compotes, and coulis within everyone's reach.

Always as effective and robust, in its 65th anniversary year, mill no. 5 contributed to the record for the world's largest potato puree. The record was set on 29 September 2012 using Joël Robuchon's famous recipe.

FOOD MILL

Allows the preparation of coulis, compotes and purees with ease. Equipped with 3 grids of different sizes. Household size.

3 sieves 1.5 - 2.5 - 4 mm

Stainless steel

1 kg/mn



Réf.					
N3004X	40	24,5	17	0,95	Ø 24 cm - Packaging Louis Tellier

TINNED FOOD MILL N.2

Allows the preparation of coulis, compotes and purees with ease. Equipped with 3 grids of different sizes. Household model.

3 sieves : Ø 1.5 - 2.5 - 4 mm

Tinned steel

1 kg/mn



Réf.				
S2	24	22	1,1	

TINNED FOOD MILL N.3

Semi-professional food mill.

< 20 persons

3 sieves : Ø 1.5 - 2.5 - 4 mm

Tinned steel

1,5 kg/mn



Réf.				
S3	31	25	1,5	

SIEVES FOR TINNED FOOD MILL N.2 & N.3

Ø 1,5 mm for coulis, Ø 2,5 mm for mashed potatoes, oval 4 mm for mozzarella. Adapted to n°3 tinned food mills, interchangeable.

Tinned steel

1,5 kg/mn



Réf.						
S3015	14	14	2	0,06	Ø 1.5 mm	S3 / S2
S3025	14	14	2	0,06	Ø 2.5 mm	S3 / S2
S3040	14	14	2	0,06	Ø 4 mm	S3 / S2

ST/ST FOOD MILL N.3

Semi-professional food mill.

< 20 persons

3 sieves : Ø 1.5 - 2.5 - 4 mm

Stainless steel

1,5 kg/mn



Réf.				
X3-F	31	25	1,7	

SIEVES FOR ST/ST FOOD MILL N.3

Ø 1,5 mm for coulis, Ø 2,5 mm for mashed potatoes, oval 4 mm for mozzarella. Adapted to n°3 St.S. food mills, interchangeable.

Stainless steel

1,5 kg/mn



Réf.						
X3015	14	14	2	0,06	Ø 1.5 mm	X3-F
X3025	14	14	2	0,06	Ø 2.5 mm	X3-F
X3040	14	14	2	0,06	Ø 4 mm	X3-F

PROFESSIONAL TINNED FOOD MILL N.5

Restaurant model. Double crushing for maximum productivity. Interchangeable sieve discs.

< 50 persons

Tinned steel

5 kg/mn



Réf.					
M510	37	32	3,3	With Ø 1 mm sieve. On demand.	
M515	37	32	3,3	With Ø 1.5 mm sieve. On demand.	
M520	37	34	3,3	With Ø 2 mm sieve. On demand.	
M530		37	32	3,3	With sieve Ø 3 mm
M540	37	32	3,3	With Ø 4 mm sieve. On demand.	
M500	37	34	3,3	Without sieve	

SIEVES FOR TINNED FOOD MILL N.5

Designed to fit tinned food mills no. 5, interchangeable.

Tinned steel

5 kg/mn



Réf.					
M5010	20	20	8	0,6	Ø 1 mm
M5015	20	20	8	0,6	Ø 1.5 mm
M5020	20	20	8	0,6	Ø 2 mm
M5030	20	20	8	0,6	Ø 3 mm
M5040	20	20	8	0,6	Ø 4 mm

ST/ST PROFESSIONAL FOOD MILL N.5

Restaurant model. Double crushing for maximum productivity. Interchangeable sieve discs.

< 50 persons

Stainless steel

5 kg/mn



Réf.					
X510	37	32	3	With sieve Ø 1 mm. On demand.	
X515	37	32	3	With sieve Ø 1.5 mm. On demand.	
X520	37	32	3	With Ø 2 mm sieve. On demand.	
X530		37	32	3	With sieve Ø 3 mm
X540	37	32	3	With Ø 4 mm sieve. On demand.	
X500	37	32	3	Without sieve	

SIEVES FOR ST/ST PROFESSIONAL FOOD MILL N.5

Designed to fit st/st. food mills no. 5, interchangeable.

Stainless steel

5 kg/mn



Réf.		
X5010	0,65	Ø 1 mm
X5015	0,65	Ø 1.5 mm
X5020	0,65	Ø 2 mm
X5030	0,65	Ø 3 mm
X5040	0,65	Ø 4 mm

TINNED FOOD MILL N.10

For institutional establishments. Allows the production of sauces, purees, compotes or soups effortlessly and in large quantities.

< 200 persons

Tinned steel

10 kg/mn



Réf.					
P1010	39	80	13	Three-legged stand. With sieve Ø 1 mm. On demand.	
P1015	39	80	13	Three-legged stand. With sieve Ø 1.5 mm. On demand.	
P1020	39	80	13	Three-legged stand. With sieve Ø 2 mm. On demand.	
P1030		39	80	13	Three-legged stand. With sieve Ø 3 mm.
P1040	39	80	13	Three-legged stand. With sieve Ø 4 mm. On demand.	
P1000	39	80	13	Three-legged stand. Without sieve.	

SIEVES FOR TINNED FOOD MILL N.10

Adapted to n°10 tinned food mills, interchangeable.

Tinned steel

10 kg/mn



Réf.					
P10010	37	22,5	10	0,8	Ø 1 mm
P10015	22	22,5	10	0,8	Ø 1.5 mm
P10020	22,5	22,5	10	0,8	Ø 2 mm
P10030	22,5	22,5	10	0,8	Ø 3 mm
P10040	22,5	22,5	10	0,8	Ø 4 mm

ST/ST ELECTRIC FOOD MILL

Stainless steel electric mill, ideal for all types of preparation (soup, sauce, mash). Allows you to make 5 kg of preparation in 1 minute. With reverse gear.

< 500 persons

Stainless steel

5 kg/mn

50/60 Hz - 600 W



Réf.				
EX5M130	37	108	23,5	Single phased. With sieve : Ø 3 mm. On demand.
EX5M100	37	108	23,5	Single phase. Without sieve
EX5T100	37	108	23,5	3 phases. Without sieve.
EX5T130	37	108	23,5	3 phases. With sieve: Ø 3 mm.

SIEVES FOR ST/ST ELECTRIC FOOD MILL

Designed to fit electric food mills EX5, interchangeable.

Stainless steel

5 kg/mn



Réf.					
EX5010	20	20	8,5	0,49	Ø 1 mm
EX5015	20	20	8,5	0,56	Ø 1.5 mm
EX5020	20	20	8,5	0,57	Ø 2 mm
EX5030	20	20	8,5	0,53	Ø 3 mm
EX5040	20	20	8,5	0,5	Ø 4 mm

PROFESSIONAL POTATO RICER WITH LEVER

Fixed sieve 2,5 mm. With professional handle.

Stainless steel



Réf.				
N3028	29	13,5	10,5	0,65

POTATO RICER WITH LEVER

Notched to adapt to differents saucepan diameters. With handle.

3 sieves : Ø 2 - 5 - 7 mm

Stainless steel



Réf.				
N3024	32	8	16,5	0,62

POTATO MASHER

 Perfect mashed potatoes.
 Double efficacy: mash, then press.

Stainless steel



Réf.				
N3025	10,5	9	25	0,3

MANUAL TOMATO SAUCE MILL

Manual tomato and fruit squeezer (raspberries, currants, blackcurrants, baked apples, etc.)

Cast stainless steel, grade 304 and acetal resin body



Réf.				
CT3X	30	22	32	2,41

ELECTRIC TOMATO SAUCE MILL

Tomato and fruit press equipped with an electric motor.

Cast stainless steel, grade 304 and acetal resin body



Réf.				
CT3X-EL	50	23	32	10

MANUAL JUICE EXTRACTOR

Large manual tomato juicer/mill. Separates the juice from the skins, pips and residues.

Sieve Ø 1 mm. Clamp fixation.

PP, aluminium, stainless steel



Ref.			
N3031	21,3	50	1,84

SET OF 3 ST/ST SIEVES FOR JUICE EXTRACTOR

Separate the skin juice, pips and residues. Ø6 mm: pumpkin, Ø3 mm: grape and Ø1,1 mm: tomatoes and red berries.

Stainless steel



Ref.					
N3032	15	15	13,5	0,8	N3031

PROFESSIONAL MANDOLINE BRON COUCKE



LOUIS TELLIER
BIEN NE REMPLACE LE FAIT MAINT

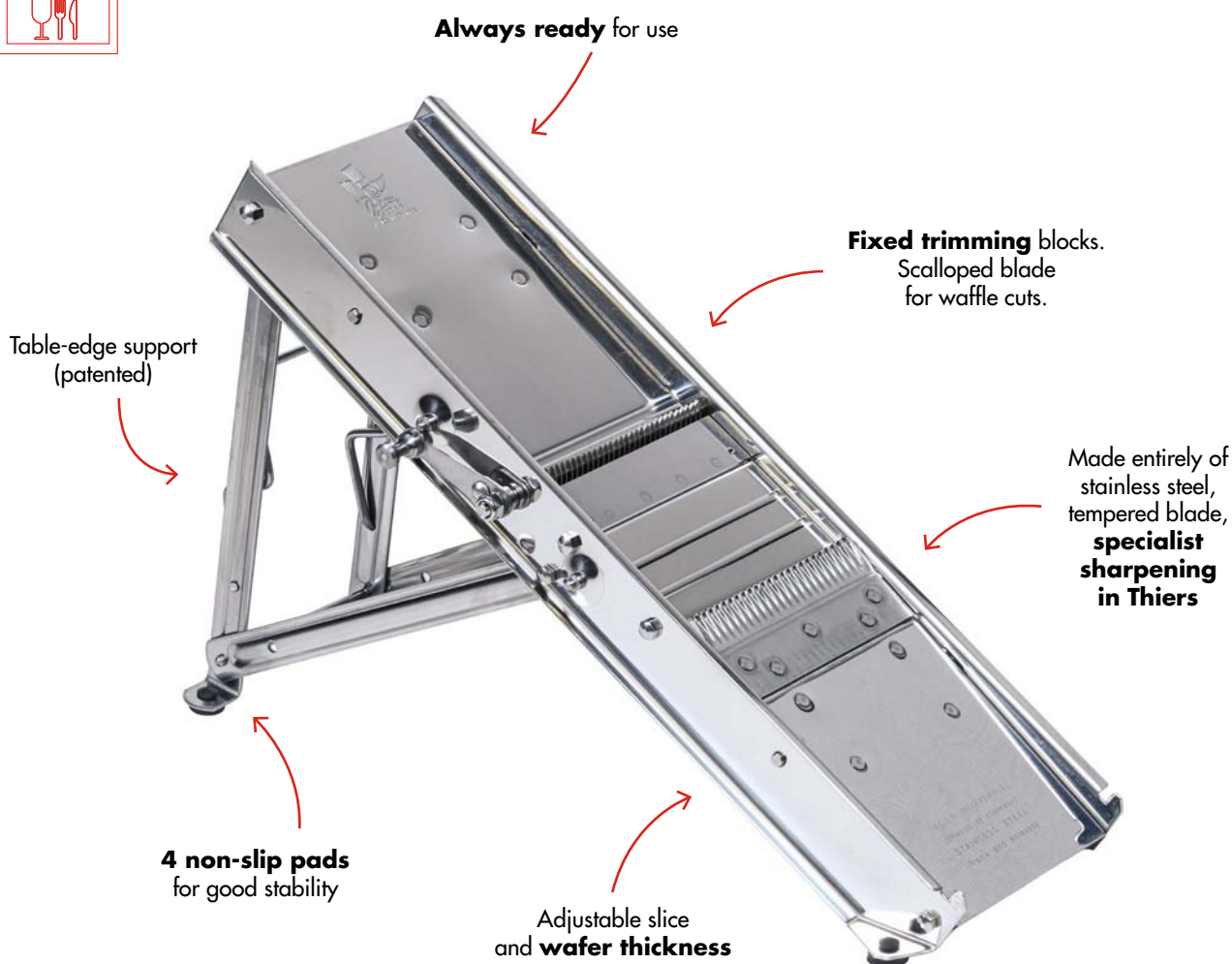

Our mandolines are ideal for:

- Variable-thickness slices of fruit and vegetables
 - Waffled slices
 - Wafers and crisps
 - Julienne-cut items
 - Angel hair
 - Thin-cut chips, matchstick potatoes, and chips.
- Optional: the protector trolley and the safety push-piece.

VIVALDI MANDOLINE

Slices thickness adjustable. Julienne 2mm and french fries 10 mm.

2 cutting blades units safety guard, non-slip stand and handle

Stainless steel, ABS



Ref.				
10000	40	13,5	5,5	1,41

THE CHEF'S MANDOLINE

Adjustable slices and waffle cuts thickness. Reversible. Smooth or embossed slices, straw potatoes, French fries and julienne 2 - 4 - 7 and 10 mm.

Non-slip stands and handles. 4 interchangeable cutting blades units, smooth blade and corrugated blade. Pusher.

Stainless steel, ABS



Ref.				
15000	40	13,5	5,5	1,5

SUPER PROFESSIONAL MANDOLINE

Adjustable thickness of slices and wafers. Smooth or embossed slices, angel hair, fries and julienne 1 - 2 - 4 - 7 and 10 mm.

Table edge support, 5 interchangeable taper blocks, smooth blade, embossed blade. Pusher.

Stainless steel



Ref.				
25000	40	11,5	4	1,5

UNIT BLADE CUTTING

For a perfect slice.

ABS



Ref.						
10202	10	0,8	2,5	0,03	2 mm	10000 / 25000 / 15000
10210	10	1,8	2,5	0,03	10 mm	10000 / 25000 / 15000
10211	13	9	3,5	0,03	2,4,7,10 mm	10000 / 25000 / 15000

PROFESSIONAL MANDOLINE WITH PROTECTIVE CARRIAGE - 3 & 10 MM

Adjustable slices thickness and waffle cuts. Smooth or embossed slices, French fries and julienne.

Table edge support, 2 integrated cutting blade units, smooth blade and corrugated blade

Stainless steel



Ref.					
20638CHB	41	13,5	4,5	1,8	Protective carriage with plastic handle
20638CHBB	41	13,5	4,5	1,8	Protective carriage with wooden handle

PROFESSIONAL MANDOLINE WITHOUT PROTECTIVE CARRIAGE

Adjustable slices thickness and waffle cuts. Smooth or embossed slices, French fries and julienne.

Table edge support, 2 cutting blade units, smooth blade and corrugated blade Without carriage or guard pusher

Stainless steel



Ref.					
20638B	41	13,5	4,5	1,5	3 & 10 mm (french fries & straw potatoes)
20644B	41	13,5	4,5	1,5	3 & 7 mm (matchsticks & straw potatoes)
20660B	41	13,5	4,5	1,5	2 & 4.5 mm (straw potatoes & julienne)

UNIVERSAL SAFETY HAND-GUARD

Prevents from cuts. Suitable for waffle cuts.

ABS



Réf.	Ø	I	P	W
10201	9	5	0,11	For all Louis Tellier mandolines

PROTECTIVE CARRIAGE

Prevents from cuts. Not suitable for waffle cuts.

Stainless steel, plastic handle



Réf.	W	I	P	W	M	U
30300	17	12	6	0,37	Plastic handle	Mandolines pro & super pro
30400	17	12	6	0,4	Wooden handle	Mandolines pro & super pro

TWO WAY EXPRESS SLICER

Adjustable cutting thickness: 1,2 to 5 mm. To cut quickly and safely all fruits and vegetables.

Complete pusher (carriage+pusher+cylinder) : L : 15 cm - H : 18 cm.

Loading spout Ø 89 mm. HDPE pusher.

Stainless steel, HDPE



Réf.	W	I	P	W
TAT	54	12	13	3,4

CABBAGE GRATER

Beechwood, stainless steel



Réf.	W	I	P	W
N7010	60	23	9	2,24

JAPANESE MANDOLINE SLICER - PREMIUM RANGE

Adjustable cut thickness (plain blade) from 0.5 to 5 mm.

Wide non-slip base, 1 ergonomic guard and 3 julienne cutting blades (1 - 2 - 4 mm).

ABS, stainless steel



Réf.	W	I	P	W	M
64JB	32	11	4	0,39	Width 65 mm
95JB	36,5	14,5	4,5	0,61	Width 95 mm
120JB	32,5	15	5	0,6	Width 120 mm

JAPANESE MANDOLINE SLICER - STANDARD RANGE

Thermal resistance: 70°C (160°F). Cutting thickness adjustable from 0,5 to 5 mm.

3 julienne cutting blades (1 - 2 - 4 mm) and 1 safety pusher

ABS, stainless steel



Réf.	W	I	P	W	M
8486JAPP	32	12	5	0,36	Width 65 mm

ACCESSORIES FOR JAPANESE MANDOLINES

For thin slicing.

Stainless steel



Ref.						
8485FI	14,5	2	0,1	0,02	Fine cutting blade large model	8485JAPGN / 95JB
8485LA	14,5	2	0,1	0,02	Medium cutting blade for large model	8485JAPGN / 95JB
8485MO	14,5	2	0,1	0,02	Large cutting blade large model	8485JAPGN / 95JB
8486FI	10,5	2	0,1	0,02	Fine cutting blade small model	8486JAPP / 64JB
8486LA	10,5	2	0,1	0,02	Large cutting blade small model	8486JAPP / 64JB
8486MO	10,5	2	0,1	0,02	Medium cutting blade for small model	8486JAPP / 64JB

ST/ST TRUFFLE AND VEGETABLE SLICER

Adjustable cutting thickness with cog-wheel. Truffles, mushrooms, parmesan, chocolate...

Notched blade

Stainless steel



Ref.				
1020RT	18	8	2	0,1

TRUFFLES MANDOLINE

Cutting width: 5,8 cm. Adjustable and precise cutting thickness: 0,1 to 4 mm.

Stainless steel



Ref.				
1010CT	18	7	2	1,1

WOODEN TRUFFLE AND VEGETABLE SLICER

Adjustable cutting thickness with cog-wheel. Truffles, mushrooms, parmesan, chocolate...

Notched blade

Stainless steel, olive wood



Ref.				
1030RT	20,7	9	2,5	0,11

FRENCH-FRIES CUTTER



LOUIS TELLIER
BIEN NE REMPLACE LE FAIT MAIN

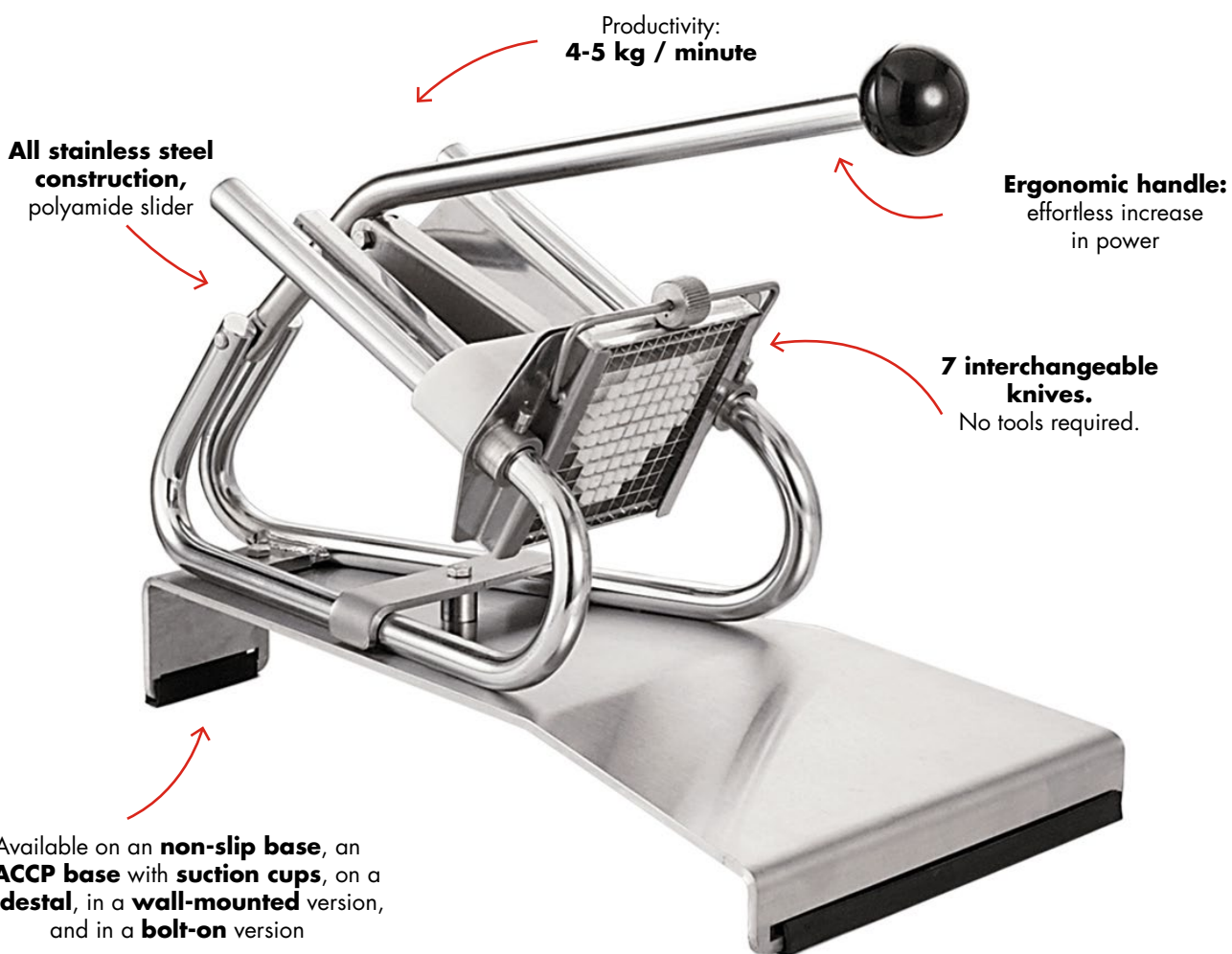
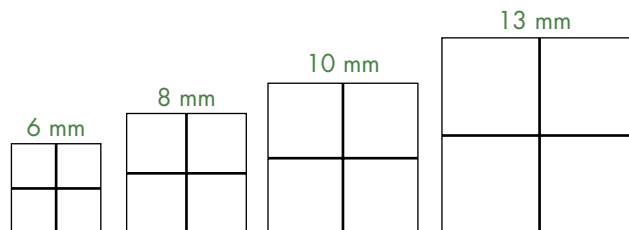

Homemade French fries, the best fries for a queen of the plate!

Home French fries are known for their incomparable taste and texture, crispy on the outside and soft on the inside. No more pre-cooked or frozen fries! In France, in restaurants, the «homemade French fries» designation is obtained by peeling potatoes and preparing them on the spot.

In 1960, Jean Tellier (Louis Tellier's son) came up with a chip cutter to a new design; he exhibited it at the Paris Fair. The chip cutter was swiftly made in hundreds of thousands of units and went around the world. Tellier's invention was awarded a prize at the Stockholm International Design Competition, and took part in the worldwide success of the «French-style chip» as well as the business's worldwide reputation.

PROFESSIONAL FRENCH FRIES CUTTER ON TRIPOD

Functional working height, high productivity.

Stainless steel, chrome plated steel, epoxy, PA slide

4-5 kg/min.



Réf.					
CP06	65	54	90	10,05	With knife and pusher : 6 mm. On demand.
CP08	65	54	90	10,05	With knife and pusher : 8 mm
CP10	65	54	90	10,05	With knife and pusher : 10 mm
CP13	65	54	90	10,05	With knife and pusher : 13 mm. On demand.
CP00	65	54	90	10,05	Without knife and pusher

PROFESSIONAL FRENCH FRIES CUTTER TO SCREW

To be fixed on a table. Compact. Comfortable grip. Great productivity.

Stainless steel, chrome plated steel, PA

4-5 kg/min.



Réf.					
C06	30	18	26	4	With knife and pusher : 6 mm
C08	30	18	26	4	With knife and pusher : 8 mm
C10	30	18	26	4	With knife and pusher : 10 mm
C13	30	18	26	4	With knife and pusher : 13 mm
C00	30	18	26	3,74	Without knife and pusher

FRENCH FRIES CUTTER ON EPOXY BASE

Comfortable grip. Great productivity. No fixing required.

Stainless steel, chrome plated steel, epoxy, PA

4-5 kg/min.



Réf.					
CS06	44	25	35	6,5	With knife and pusher : 6 mm
CS08	44	25	35	6,5	With knife and pusher : 8 mm
CS10	44	25	35	6,5	With knife and pusher : 10 mm
CS13	44	25	35	6,5	With knife and pusher : 13 mm. On demand.
CS00	44	25	35	6,5	Without knife and pusher

FRENCH FRIES CUTTER - ST/ST BASE

Comfortable grip. Great productivity. No fixing required.

Stainless steel, PA

4-5 kg/min.



Réf.					
CX06	44	25	35	6,7	With knife and pusher : 6 mm. On demand.
CX08	44	25	35	6,7	With knife and pusher : 8 mm
CX10	44	25	35	6,7	With knife and pusher : 10 mm
CX13	44	25	35	6,7	With knife and pusher : 13 mm
CX00	44	25	35	6,7	Without knife and pusher

HACCP PROFESSIONAL FRENCH FRIES CUTTER

On board HDPE500 with suction cups for optimal stability. Comfortable grip. High productivity.

Stainless steel, HDPE board, PA

4-5 kg/min.

LOUIS TELLIER

Réf.					
CX06-P	42	24	30	6	With knife and pusher : 6 mm. On demand.
CX08-P	42	24	30	6	With knife and pusher : 8 mm
CX10-P	42	24	30	6	With knife and pusher : 10 mm
CX13-P	42	24	30	6	With knife and pusher : 13 mm. On demand.
CX00-P	42	24	30	6	Without knife and pusher

FRENCH FRIES CUTTER - COMPACT PRO

Professional quality. Functional by its small size (restaurants, food-truck ...). Cutting precision 10x10mm. Small and medium product calibration. Easy to use. Solid. Productivity gain.

Stainless steel et nickeled steel

3-4 kg/min.

LOUIS TELLIER

Réf.					
CSP10	25	13	21	1,9	With knife 10x10 mm + pusher

DOMESTIC FRENCH FRIES CUTTER

Domestic use. Suction base.

Stainless steel, PP

LOUIS TELLIER

Réf.					
N3023VLT	26	9	12,5	0,9	

WALL MOUNTED FRENCH FRIES CUTTER

To be fixed to the wall. Great productivity.

Stainless steel, chrome plated steel, epoxy, PA

4-5 kg/min.

LOUIS TELLIER

Réf.					
CM06	40	17,5	29	4	With knife and pusher : 6 mm. On demand.
CM08	40	17,5	29	4	With knife and pusher : 8 mm
CM10	40	17,5	29	4	With knife and pusher : 10 mm
CM13	40	17,5	29	4	With knife and pusher : 13 mm
CM00	40	17,5	29	3,95	Without knife and pusher

BLADE + PUSHER FOR FRENCH FRIES CUTTER COMPACT PRO

Stainless steel, PP et PA

LOUIS TELLIER

Réf.						
LT20A009	9,5	9,5	1,5	0,1	10x 10 mm	CSP10

DOMESTIC BLADES + PUSHER KIT

Stainless steel, PP



Réf.						
N3023-09	7,5	8	2	0,11	9 x 9 mm	N3023V / N3023VLT
N3023-12	7	8	2,5	0,11	12 x 12 mm.	N3023V / N3023VLT

TINNED BLADES + PUSHER KIT

Compatible for tinned chips cutters.

Tinned steel, PP



Réf.			
C006	0,24	6 x 6 mm	CP / C / CS / CM
C008	0,24	8 x 8 mm	CP / C / CS / CM
C010	0,24	10 x 10 mm.	CP / C / CS / CM
C013	0,24	13 x 13 mm.	CP / C / CS / CM
C020	0,24	10 x 20 mm.	CP / C / CS / CM
C022	0,24	20 x 20 mm.	CP / C / CS / CM
C00K	0,24	Potatoes	CP / C / CS / CM

TINNED BLADES

Compatible with tinned french-fries cutters.

Tinned steel



Réf.			
CF106	0,18	6 x 6 mm	CP / C / CS / CM
CF108	0,175	8 x 8 mm	CP / C / CS / CM
CF110	0,162	10 x 10 mm.	CP / C / CS / CM
CF113	0,15	13 x 13 mm.	CP / C / CS / CM
CF120	0,14	10 x 20 mm	CP / C / CS / CM
CF122		20 x 20 mm	CP / C / CS / CM
CF1K	0,17	Potatoes	CP / C / CS / CM

PUSHER FOR FRENCH FRIES CUTTER

PP



Réf.			
CF206	0,03	6 x 6 mm	CP / C / CX / CS / CM
CF208	0,04	8 x 8 mm	CP / C / CX / CS / CM
CF210	0,04	10 x 10 / 20 x 20 / 10 x 20 mm	CP / C / CX / CS / CM
CF213	0,03	13 x 13 mm.	CP / C / CX / CS / CM
CF2K	0,3	Potatoes	CP / C / CX / CS / CM

ST/ST BLADES + PUSHER KIT

Compatible with st/st french-fries cutters.

Stainless steel, PP



Réf.			
C006X	0,19	6 x 6 mm	CX
C008X	0,19	8 x 8 mm	CX
C010X	0,15	10 x 10 mm	CX
C013X	0,3	13 x 13 mm.	CX

ST/ST BLADES

Compatible with st/st french-fries cutters.

Stainless steel



Réf.			
CF306	0,17	6 x 6 mm	CX
CF308	0,02	8 x 8 mm	CX
CF310	0,02	10 x 10 mm.	CX
CF313	0,12	13 x 13 mm.	CX

CARRIAGE FOR FRENCH FRIES CUTTER

PA







Réf.					
CF0007	16	8	3,5	0,1	COUPE FRITES

TWISTER SLICER FRIT'N CHIPS - FASTENER AND CLAMP

Cutting thickness : 2.25 mm. Innovation : spiral potato chips on a stick!

 Stainless steel



Réf.					
CNX225	33	13	45	3,87	Clamp fixation

TWISTER SLICER FRIT'N CHIPS - SUCTION CUP FIXING

Cutting thickness: 2.25 mm. Innovation: spiral potato chips on a stick!

 Stainless steel





Réf.					
CNX225-V	33	15	22	4,04	Suction base

BLADE FOR TWISTER SLICER FRIT'N CHIPS

Blade for Spirale Frit'n Chips. 2 thicknesses.

 Stainless steel



Réf.			
CNX225-L	0,024	Cutting thickness : 2.25 mm	CNX225 / CNX225-V
CNX450-L	0,024	Cutting thickness : 4.5 mm	CNX225 / CNX225-V



TOMATO MOZZARELLA SLICER



LOUIS TELLIER
NEUF NE REMPLACE LE TROISIÈME



Made in France



NO PRODUCT WASTE:
11 hollow-edge blades glide cleanly through the food

PRACTICAL:
Raised trolley to eject the slices into a GN H65 tray. Appliance with **table wedge** and safety pin

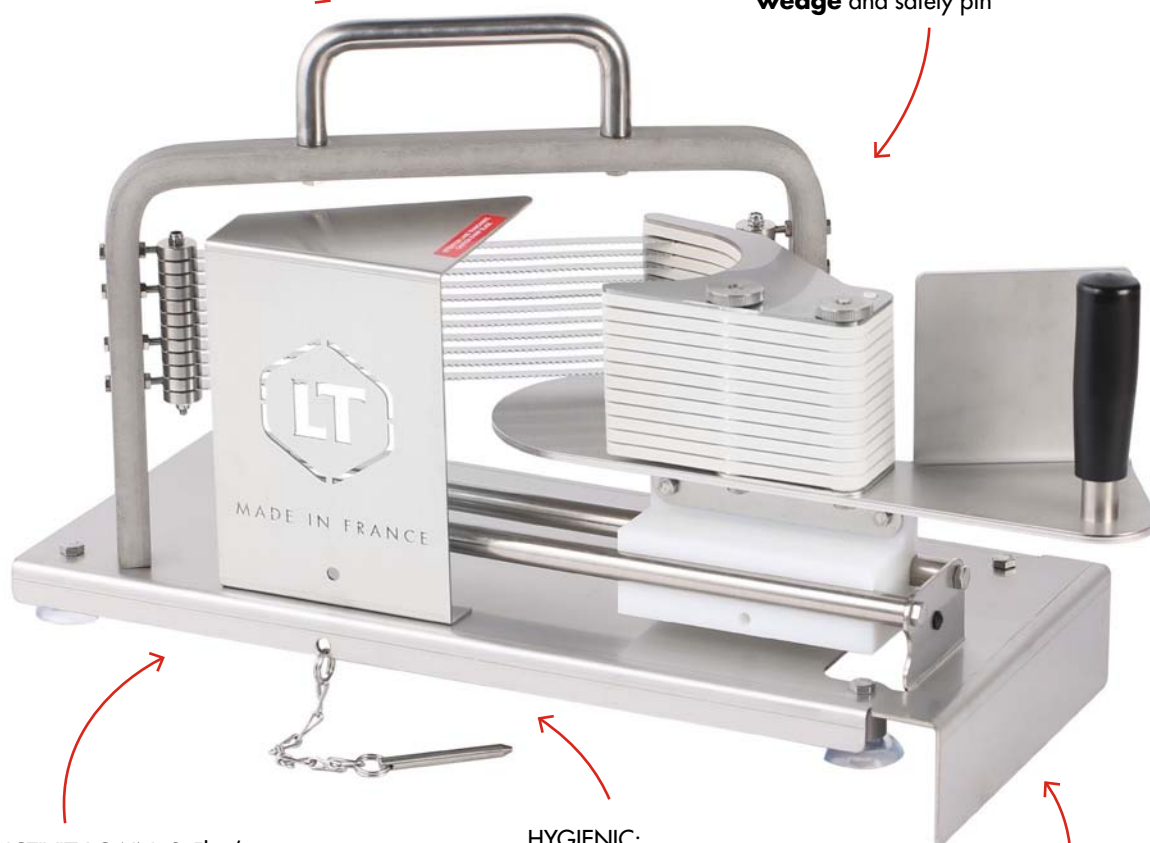

PRODUCTIVITY GAIN: 3.5kg/min. - 1pc./ 2.5sec.
Cuts the whole product easily in **only 1 gesture** in **regular 5.5mm slices**

HYGIENIC:
100% stainless steel and HDPE pusher, **easy to clean**

RESPECT OF PRODUCT: Fitted pusher + fine and tight teeth of the blades for **perfect piercing** of delicate skin and flesh

This tomato mozzarella slicer is adapted to the requirements of large productions such as collectivities and fast-food restaurants.

Ideal for pizzas, salads, hamburgers or sandwiches.

TOMATO MOZZARELLA SLICER

The 1st Mozzarella Slicer. 11 blades especially sharpened for slicing and respecting tender flesh. Regular slices. Sliding trolley on HDPE, raised to eject the sliced product in a GN H65 tray. For communities, pizzeria, fast-food...

Stainless steel, HDPE et PP strips

3,5 kg/min. 1 pc. / 2,5 sec.



LOUIS TELLIER NF

Réf.					
CT-MZ	48	20	32	7,6	Slices : 5.5 mm

ST/ST TOMATO SLICER

Sliding trolley on HDPE, elevated for ejection in a GN h65 tray. Uniform tomatoes, citrus fruit (exc. CTX40), kiwis...slices. Large scale production: communities, fast-food.

Stainless steel, HDPE and PP slat

3,5 kg/min. 1 pc. / 2,5 sec.



LOUIS TELLIER NF NSF

Réf.					
CTX	45,5	20	30	7,6	Slices : 5.5 mm
CTX40	48	20	27,5	8	Slices : 4 mm

ST/ST TOMATO SLICER - COMPACT PRO

Uniform tomatoes slices: 5,5 mm. Small restaurants, pizzas, sandwiches.

Stainless steel, HDPE



LOUIS TELLIER

Réf.				
CTXM55	30	15	17	2

SHORT VERSION TOMATOES AND CITRUS WEDGE CUTTER

Quick and regular cutting of fruits and vegetables without pits. Adapted to the high productivity requirements of communities and fast food.

Stainless steel, ABS



Réf.					
CAX204	38,5	19	39	2,1	4 wedges
CAX206	38,5	19	39	2,1	6 wedges
CAX208	38,5	19	39	2,1	8 wedges
CAX212	38,5	19	39	2,1	12 wedges

HIGH VERSION TOMATOES AND CITRUS WEDGE CUTTER

Quick and regular cutting of fruits and vegetables without pits. Adapted to the high productivity requirements of communities and fast food.

Stainless steel, ABS



LOUIS TELLIER NF NSF

Réf.					
CAX104	38,5	32,5	58	3	4 wedges
CAX106	38,5	32,5	58	3	6 wedges
CAX108	38,5	32,5	58	3	8 wedges
CAX112	38,5	32,5	58	3	12 wedges

CORING TOOL FOR TOMATOES

Perfect to core tomatoes before cutting with tomato slicer.

Stainless steel



LOUIS TELLIER

Réf.				
N3078	10,5	2	1	0,01

LETTUCE CUTTER

Time savings: 1) Cut. 2) Wash. 3) Wring. Ideal for sandwiches, kebobs, salad bar, large institutional establishments.

Security: system that holds back the pusher

Stainless steel, HDPE



Réf.					
CSA	39	30	120	19,5	Cutting : 23 x 23 mm
CSAL	39	30	120	19,5	Strips : 12 x 100 mm

COMPACT ST/ST LETTUCE CUTTER

Cutting : 25 x 25 mm.

Stainless steel, HDPE



Réf.				
CSAM	30	31	97	10,3

BLADE BLOC FOR LETTUCE CUTTER

Block of interchangeable blades with the same CSAL02 pusher .

Stainless steel



Réf.			
CSA01	1,95	Blade 23 x 23 mm	CSA / CSAL
CSAL01	2	Blade 12 x 100 mm	CSAL

PUSHER FOR LETTUCE CUTTER

Robust and durable. Disassembles easily.

HDPE



Réf.						
CSA02	19	19	5	0,8	23 x 23 cm	CSA
CSAL02	19	19	5	0,9	12 x 100 mm	CSA / CSAL

BLADE BLOC FOR COMPACT LETTUCE CUTTER

For a perfect slice.

Stainless steel, HDPE



Réf.	
CSAM01	CSAM

PUSHER FOR COMPACT LETTUCE CUTTER

Robust and durable. Disassembles easily.

Stainless steel, HDPE



Réf.	
CSAM02	CSAM



STRIP CUTTER



LOUIS TELLIER



Made in France

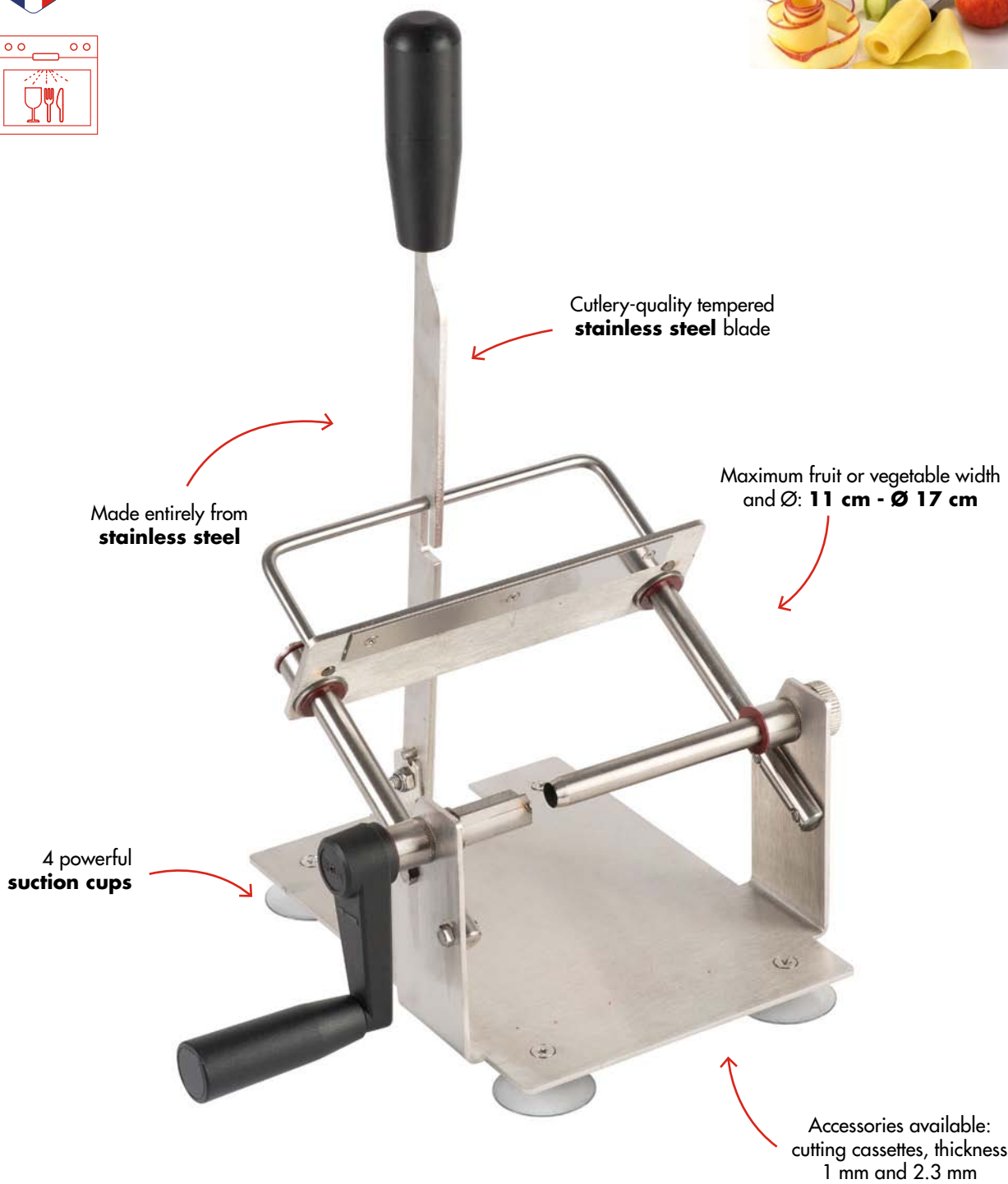

To cut firm and even fruits and vegetables in wide and fine bands. To redesign lasagne, millefeuille, spring rolls, vegetable terrines, etc.

STICK SLICER WITH LEVER

For sticks and French fries. Leverage effect for increased efficiency.

Stainless steel, HDPE, PP, ABS



Réf.					
CC08	35,5	26	66	4	8 x 8 mm
CC10	35,5	26	66	4	10 x 10 mm

PUSHER

Robust and durable. Disassembles easily.

PP



Réf.		
CC208.	8 x 8 mm	FPN08 / FPN10 / CC08 / CC10
CC210.	10 x 10 mm	FPN08 / FPN10 / CC08 / CC10

JAPANESE VEGETABLE SLICER WITH LEVER

Blade: 15 cm. Maximum width and Ø of the vegetable or fruit: 11 cm - Ø 17cm. Fresh-cut and strip fruits and vegetables in thin and large strips: revisit lasagna, spring rolls, terrine, millefeuille...

Stainless steel



Réf.					
CLANX	25	23	42	2	With lever

JAPANESE VEGETABLE SLICER WITHOUT LEVER

Blade: 15 cm. Maximum width and Ø of the vegetable or fruit: 11 cm - Ø 17cm. Fresh-cut and strip fruits and vegetables in thin and large strips: revisit lasagna, spring rolls, terrine, millefeuille...

Stainless steel



Réf.					
CLANX-05	20	20	25	1,45	Without lever

JAPANESE VEGETABLE SLICER - 4 BLADES

Maximum width of the vegetable or fruit: 13 cm. Creative fresh-cut and strip fruits and vegetables: strips, capellini: revisit lasagna, spring rolls, caul fats, terrine, millefeuille...

4 blades : strip 130 thickness 0,5mm - spaghetti 1mm thickness 1,2mm - net thickness 1,2mm - fishes net thickness 1,2mm.

ABS, stainless steel blades



Réf.					
CLAN01	28	25	16,5	2,5	4 functions

JAPANESE VEGETABLE SLICER - REVERSIBLE BLADE

4 thicknesses: 0,8 - 1 - 1,2 - 1,4 mm. Width and maximum Ø of the vegetable or the fruit: 8 cm - Ø 10 cm. Creative fresh-cut and strip fruits and vegetables: strips, capellini: revisit lasagna, spring rolls, caul fats, terrine, millefeuille...

1 reversible blade: strip - lasagna and angel hair

ABS, stainless steel blades

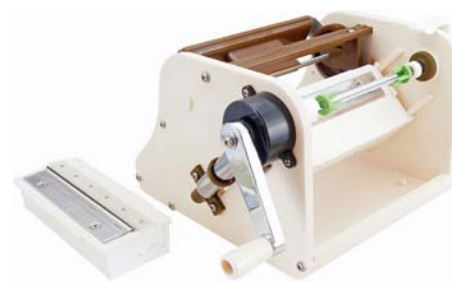

Réf.					
CLAN02	24	23	16	1,8	2 functions 4 thicknesses

«LE ROUET® GOURMET» TURNING SLICER



LOUIS TELLIER
BIEN NE REMPLACE LE FAIT MAINT



Made in France



Spaghetti and angel hair



Juliennes and tagliatelles



ABS, stainless steel

Robust stainless steel material

With 3 trimming combs: 1 mm, 2 mm and 4 mm

Highly stable thanks to 4 powerful suction cups

Cutting thickness adjustable from 1 to 4 mm

CULINARY PREPARATION

Create tagliatelle, spaghetti, and julienne-cut fruits and vegetables with just a few turns of the handles. You will easily make coleslaw, rösti, and grated potatoes. Tailored to a wide variety of fruits and vegetables, including firm-fleshed ones, like carrots, celery, onions, courgettes, cabbage and apples.

JAPANESE VEGETABLE SLICER - 2 BLADES

Maximum width of the vegetable or fruit: 13 cm. Creative fresh-cut and strip fruits and vegetables: strips, capellini: revisit lasagna, spring rolls, caul fats, terrine, millefeuille...

✂️ 2 blades : strip 130 thickness 0,5mm - spaghetti 1mm thickness 1,2mm

🔧 ABS, stainless steel blades



Ref.					
CLAN03	28	25	16,5	1,54	2 functions

JAPANESE VEGETABLE SLICER - 1 BLADE

Maximum width of the vegetable or fruit: 13 cm. Creative fresh-cut and strip fruits and vegetables: strips, capellini: revisit lasagna, spring rolls, caul fats, terrine, millefeuille...

✂️ 1 blade: strip 130 thickness 0,5 mm

🔧 ABS, stainless steel blades

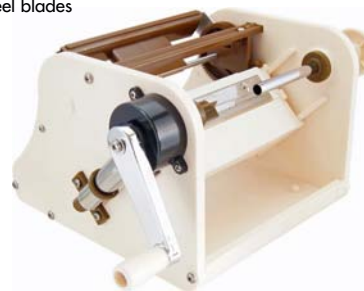

Ref.					
CLAN04	28	25	16,5	1,98	1 function

VEGETABLE SLICER LE ROUET

Cutting thickness: 0,8 mm. Heavy duty construction. Mass production of garlands, spaghetti, and fruits and vegetables tagliatelles.

✂️ Plain blade (garlands) and 3 knives filaments: 2 mm, 3 mm and 6 mm

🔧 Stainless steel, die-cast aluminium

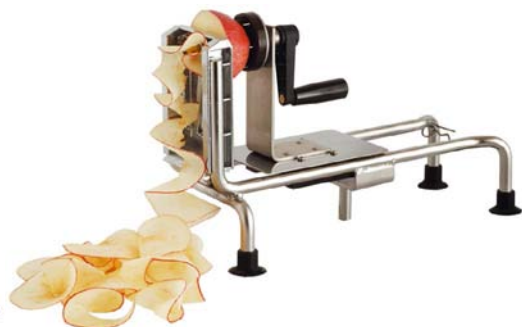

Ref.				
4030CLR	37	14	25	3

TURNING SLICER «LE ROUET GOURMET»

Adjustable cutting thickness: from 1 to 4 mm. Huge variety of capellini, spaghettis, and tagliatelles measures of fruits and vegetables.

✂️ Adjustable blade (garlands) and 3 knives filaments: 1 mm, 2 mm, 4 mm. 4 strong suction cups.

🔧 ABS, Stainless steel, die-cast aluminium



Ref.				
4100CLR	36	13	25	2,21

CHÂTEAU CUTTER

🔧 Stainless steel, HDPE



Ref.						
MLT.	31	17	26	3,2	Complete device	
MLT01.				0,01	Spare blade only	MLT

JAPANESE VEGETABLE TURNING

Cutting thickness: 0,8 mm. Perfect cut very thin: capellini, spaghettis, tagliatelles.

✂️ Plain blade (garlands) and 3 knives filaments: 1 mm - 2,5 mm and 4 mm

🔧 ABS, stainless steel blades

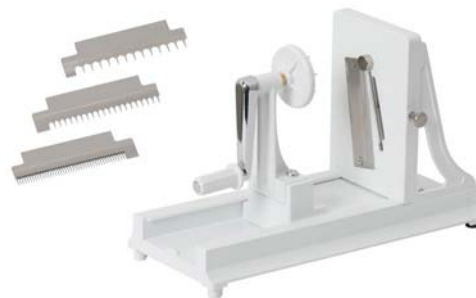

Ref.				
4500CLR	27	12	17,5	0,53

St/st Multi-Cutting Chopper Kit

ALLIGATOR
FAMILY

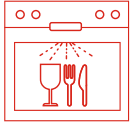

With **3** knives: 3x3
6x6 - 9x9 mm

To **slice** onions thinly, **cut** chips,
and **chop** garlic



Collecting tray

Stainless steel

In 2001, the inventor Benny Engdah designed the Alligator out of a wish to make it easier to prepare his favourite Swedish dish: Kroppkakor, potato balls garnished with sliced onions and bacon.

He registered a patent, and success quickly spread worldwide: the ease of using the revolutionary vegetable cutter won over professional chefs as well as individuals.

Pierre Tellier, as a manufacturer of professional devices for cutting fruit and vegetables, was naturally won over by the small, efficient, and space-saving device, and introduced the Alligator to France in 2005.

The Alligator vegetable cutter stands out by its robustness as well as the quality of its blades and grills.

ALLIGATOR ORIGINAL CHOPPER

Blade: 6 x 6 mm. Minced onions in one motion.

ABS, stainless steel blades



Ref.				
N3011	28	11	4	0,38

ALLIGATOR ORIGINAL 12 X 12 MM BLADE

To cut into cubes / french fries.

ABS, stainless steel blades



Ref.					
N3011-C	28	11	4	0,21	N3011 / N3011R

ALLIGATOR ORIGINAL CHOPPER WITH COLLECTOR

Blade: 6 x 6 mm. Cut onions in one step.

With collector

ABS, stainless steel blades



Ref.				
N3011R	28	11	10	0,48

ALLIGATOR ORIGINAL 3 CHOPPER SET

Onion cutter N3011R + blade N3011-C + mini ALLIGATOR N3011M

ABS, stainless steel blades



Ref.	
N3011S	0,88

ORIGINAL ONION SLICER

Slice: 5.5 mm. For onions and tomatoes.

ABS, stainless steel blades



Ref.				
N3011T	28	11,5	6	0,9

ALLIGATOR CHOPPER KIT WITH COLLECTOR

3 knives: 3 x 3 - 6 x 6 - 12 x 12 mm. To mince the onions, cut the fries and chop the garlic. With drip tray.

3 knives : 3x3 - 6x6 - 12x12 mm

Stainless steel



Ref.				
AL21P001	28	11	10	0,985

COLLECTOR

Tritan



Réf.	↔	↗	⌋	📦	📎
N3011-B	12,5	9,5	7	0,12	N3011R
N3011-BX	12,5	9	7	0,09	N3011X

ALLIGATOR BLADES + PUSHERS KIT

Dish washer safe

With cleaning grid

PP, stainless steel blades



Réf.	↔	↗	⌋	📦	🔍	📎
N3011X-09K	12,2	10	2	0,3	9 mm	N3011X
N3011X-K	12,2	10	2	0,3	3 + 6 + 12 mm.	N3011X

KNIFE

Dishwasher safe.

PP, stainless steel blades



Réf.	↔	↗	⌋	📦	🔍	📎
N3011X-03	12	10	0,8	0,6	3 mm	N3011X
N3011X-06	12	10	0,8	0,6	6 mm.	N3011X
N3011X-12	12	10	0,8	0,6	12 mm.	N3011X

MINCING KNIFE

To mince herbs, garlic, onions, shallots... 2 to 3 times faster.

Tempered stainless steel blades, ABS handles

LOUIS TELLIER

Réf.	↔	↗	⌋	📦	🔍
N3236	22	5,3	14,2	1	3 blades of 300 mm

GARLIC PRESS - HIGH OUTPUT

Robust construction. Pusher retaining the membrane: easy cleaning. Press up to 5 cloves one after the other. Collect the pulp with a boost on the tab. No loss.

«Little shovel» tab.

Zinc alloy with chrome plating, nylon

LOUIS TELLIER

Réf.	↔	↗	⌋	📦
N4298	17,5	3,5	6	0,38



ALLIGATOR®

PEELER FOR INSTITUTIONAL ESTABLISHMENTS



LOUIS TELLIER
BIEN NE REMPLACE LE FAIT MAINT



Made in France

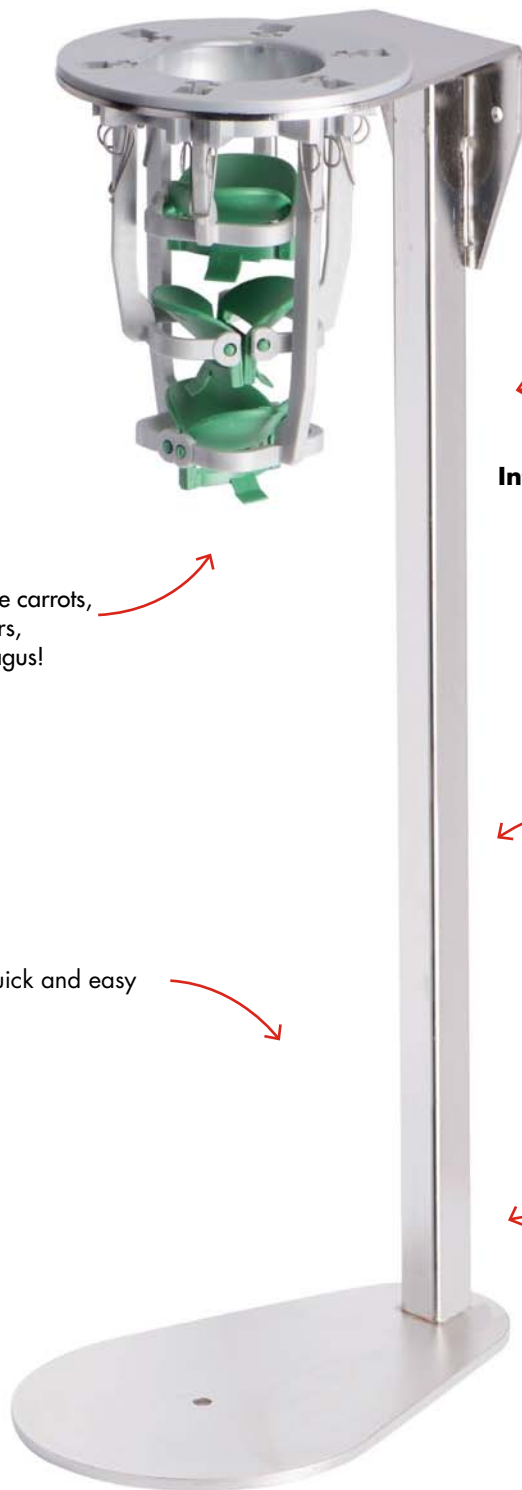

For carrots, large carrots, cucumbers, and asparagus!

Interchangeable heads

Perfect peeling

Quick and easy

No loss:
fine peelings

Our peelers will win you over with their various qualities:

- Time-saving: 100 kg of carrots or 600 cucumbers an hour
- Easy to use: insert the vegetables at the top and pull towards the bottom
- No loss: peelings are very fine
- Easy to clean

Several models (on stand, to fix...) available for carrots (small and large), cucumbers and asparagus.

ST/ST WALL MOUNTED PEELER - CARROTS

Enables high yield peeling. Easy to use. No loss thanks to fine peelings.

Stainless steel, PA, stainless steel blades and stand



Ref.					
EMX001	12,5	17	24	0,76	∅ introduction : 4.5 cm

ST/ST WALL MOUNTED PEELER - BIG CARROTS

Enables high yield peeling. Easy to use. No loss thanks to fine peelings.

Stainless steel, PA, stainless steel blades and stand



Ref.					
EMX002	12,5	17	24	0,76	∅ introduction : 6 cm

ST/ST WALL MOUNTED PEELER - CUCUMBERS

Enables high yield peeling. Easy to use. No loss thanks to fine peelings.

Stainless steel, PA, stainless steel blades and stand



Ref.					
EMX003	12,5	25	25,5	0,76	∅ introduction : 6 cm

ST/ST WALL MOUNTED PEELER - ASPARAGUS

Enables high yield peeling. Easy to use. No loss thanks to fine peelings.

Stainless steel, PA, stainless steel blades and stand



Ref.					
EMX004	12,5	17	24	0,76	∅ introduction : 4.5 cm

EPOXY WALL MOUNTED PEELER - CARROTS

Enables high yield peeling. Easy to use. No loss thanks to fine peelings.

Steel stand, epoxy, PA, stainless steel blades



Ref.					
EM001.	12,5	17	24	0,5	∅ introduction : 4.5 cm

EPOXY WALL MOUNTED PEELER - BIG CARROTS

Enables high yield peeling. Easy to use. No loss thanks to fine peelings.

Steel stand, epoxy, PA, stainless steel blades



Ref.					
EM002.	12,5	17	24	0,5	∅ introduction : 6 cm

EPOXY WALL MOUNTED PEELER - CUCUMBERS

Enables high yield peeling. Easy to use. No loss thanks to fine peelings.

Steel stand, epoxy, PA, stainless steel blades



Ref.					
EM003.	12,5	17	24	0,5	Ø introduction : 6 cm

EPOXY WALL MOUNTED PEELER - ASPARAGUS

Enables high yield peeling. Easy to use. No loss thanks to fine peelings.

Steel stand, epoxy, PA, stainless steel blades



Ref.					
EM004	12	17	24	0,5	Introduction Ø : 4.5 cm

ST/ST PEELER ON STAND - CARROTS

Enables high yield peeling. Easy to use. No loss thanks to fine peelings.

Stainless steel, PA, stainless steel blades and stand



Ref.					
EPX001.	21,5	14	51	1,8	Ø introduction : 4.5 cm

ST/ST PEELER ON STAND - BIG CARROTS

Enables high yield peeling. Easy to use. No loss thanks to fine peelings.

Stainless steel, PA, stainless steel blades and stand



Ref.					
EPX002.	21,5	14	51	1,8	Ø introduction : 6 cm

ST/ST PEELER ON STAND - CUCUMBERS

Enables high yield peeling. Easy to use. No loss thanks to fine peelings.

Stainless steel, PA, stainless steel blades and stand



Ref.					
EPX003.	21,5	14	51	1,8	Ø introduction : 6 cm

ST/ST PEELER ON STAND - ASPARAGUS

Enables high yield peeling. Easy to use. No loss thanks to fine peelings.

Stainless steel, PA, stainless steel blades and stand



Ref.					
EPX004	21,5	14	51	1,8	Ø introduction : 4.5 cm

EPOXY PEELER ON STAND - CARROTS

Enables high yield peeling. Easy to use. No loss thanks to fine peelings.

Epoxy painted steel stand, PA, stainless steel blades



Ref.					
EPO01.	21,5	14	51	1,8	Ø introduction : 4.5 cm



EPOXY PEELER ON STAND - BIG CARROTS

Enables high yield peeling. Easy to use. No loss thanks to fine peelings.

Epoxy painted steel stand, PA, stainless steel blades



Ref.					
EPO02.	21,5	14	51	1,8	Ø introduction : 6 cm



EPOXY PEELER ON STAND - CUCUMBERS

Enables high yield peeling. Easy to use. No loss thanks to fine peelings.

Epoxy painted steel stand, PA, stainless steel blades



Ref.					
EPO03.	21,5	14	51	1,8	Ø introduction : 6 cm



EPOXY PEELER ON STAND - ASPARAGUS

Enables high yield peeling. Easy to use. No loss thanks to fine peelings.

Epoxy painted steel stand, PA, stainless steel blades



Ref.					
EPO04.	21,5	14	51	1,8	Ø introduction : 4.5 cm



PEELER WITH CLAMP FIXATION - CARROTS

Enables high yield peeling. Easy to use. No loss thanks to fine peelings.

Stainless steel, PA, stainless steel blades and stand



Ref.					
ESJX001	22	12,6	10	1,25	Ø introduction : 4.5 cm



PEELER WITH CLAMP FIXATION - BIG CARROTS

Enables high yield peeling. Easy to use. No loss thanks to fine peelings.

Stainless steel, PA, stainless steel blades and stand



Ref.					
ESJX002	22	12,6	10	1,25	Ø introduction : 6 cm



PEELER WITH CLAMP FIXATION - CUCUMBERS

Enables high yield peeling. Easy to use. No loss thanks to fine peelings.

Stainless steel, PA, stainless steel blades and stand



Ref.					
ESJX003	22	12,6	10	1,25	∅ introduction : 6 cm

PEELER WITH CLAMP FIXATION - ASPARAGUS

Enables high yield peeling. Easy to use. No loss thanks to fine peelings.

Stainless steel, PA, stainless steel blades and stand



Ref.					
ESJX004	22	12,6	10	1,25	∅ introduction : 4.5 cm

PEELING HEADS - CARROTS

Interchangeable peeling heads. Spare parts (springs, blades, arms, connector board) availables.

With pusher

Reinforced polyamide, stainless steel



Ref.					
E0010.	4,5	22	0,16	Carrots head	EM / EP / EPX / ESJX

PEELING HEADS - BIG CARROTS

Interchangeable peeling heads. Spare parts (springs, blades, arms, connector board) availables.

With pusher

Reinforced polyamide, stainless steel



Ref.					
E0011.	6	20	0,28	Big carrots head	EM / EP / EPX / ESJX

PEELING HEADS - CUCUMBERS

Interchangeable peeling heads. Spare parts (springs, blades, arms, connector board) availables.

Reinforced polyamide, stainless steel



Ref.					
E0012.	6	16	0,15	Cucumbers head	EM / EP / EPX / ESJX

PEELING HEADS - ASPARAGUS

Interchangeable peeling heads. Spare parts (springs, blades, arms, connector board) availables.

Reinforced polyamide, stainless steel



Ref.					
E0019.	4,5	15,5	0,14	Asparagus head	EM / EP / EPX / ESJX

WATERMELON AND PUMPKIN PEELER

Useful width: 6,5 cm. Adjustable peeling thickness.

Stainless steel blade, ABS handle



Ref.				
ID4006	17	10,5	3,5	0,25

LARGE VEGETABLE PEELER

Useful width: 8 cm. Mango, watermelons, pumpkins.

Stainless steel



Ref.				
ID4007	20	10	1,5	0,1

ASPARAGUS PEELER

Handy tong design.

Stainless steel



Ref.				
N3079	17,5	4	1,5	0,4

ELECTRIC PEELER PROFESSIONAL

Peeling round and oval vegetables, fruits in quantities. Peeling thickness adjustable. Special feature for citrus fruits : 1 step for zest only ; 2 steps for zest and white skin. Waterproof control panel.

St/st. trident, pick and knife

3 - 4 pcs / min.

50 Hz - 24 W - 220 V



Ref.					
N4220	27	17	23,5	1,8	Professional model

SEMI-PROFESSIONAL ELECTRIC PEELER

Peeling round and oval vegetables, fruits in quantities. Peeling thickness adjustable. Special feature for citrus fruits : 1 step for zest only ; 2 steps for zest and white skin.

Plastic trident and pick, stainless steel knife

3 - 4 pcs / min.

50 Hz - 24 W - 220 V



Ref.					
N4221	26	16	23	1,8	Semi-professional model

CITRUS FRUIT MANUAL PEELER

To completely zest oranges and lemons.

Epoxy coated steel support



Ref.					
N4225	29	5	14	0,65	With clamp fixation

CASTOR VEGETABLE PEELER

4 cm useful double moving blade. Thin peel. Follows the fruits and vegetables curves.

Eyes potato remover.

Stainless steel handle, tempered carbon steel blade



Ref.				
N8012	11	6	1	0,03

VEGETABLE PEELER - JULIENNE

Double moving blade with straighten tooth. To get thin juliennes or zests.

Stainless steel handle and blades



Ref.				
N8013	11	6,2	1,2	0,03

THIN SKIN POLLUX PEELER

Double moving micro-serrated blade. Peel every skins, even thin and hairy: tomatoes, aubergines, peppers, peaches, kiwis.

Eyes potato remover

Stainless steel blade and body, PP handle



Ref.				
N8014	17,3	2	1,5	0,03

POLLUX PEELER

4 cm useful double moving blade. Thin peel. Follows the fruits and vegetables curves.

Eyes potato remover

Tempered carbon steel blade, PP handle, stainless steel body



Ref.				
N8015	17,4	2	1,5	0,03

ELECTRIC PEELER



This professional utensil enables large-volume peeling of citrus fruit, onions and all round and oval fruits and vegetables.

The difference between the 2 models : the pro model has a stainless steel trident and centring tip; those parts are made in plastic in the semi-pro model.

WEDGE CUTTER



LOUIS TELLIER
BIEN NE REMPLACE LE FAST MASH



Réf. CAX104,106,108, 112



Réf. CAX104P, 106P, 108P

CULINARY PREPARATION

Efficiency: centring the fruit gives a **regular** cut

Set of **interchangeable** blades and push-pieces

Hygiene: made from stainless steel and detergent-**resistant** composite materials, making it dishwasher-safe

Distance between feet allows the use of a Gastronorm GN 1/2 stainless-steel **collecting tray**

Safety: **no contact** with the blades. **3 suction cups** ensure good contact with the work surface

Cuts all stone-free fruit and vegetables into 4, 6, 8, or 12 sections

This tomato and citrus cutter, high-section version, is tailored to the requirements of large-scale production, e.g. community catering and fast-food establishments. Cuts tomatoes, citrus fruits, kiwi fruit, etc., into sections.

Coring knife available as accessory.

LEMON CUTTER - HALF AND WEDGES

¼ slice (6 mm cut): Mojito, Caïpirinha and Ti-punch, prepared three times faster.
 ½ slice (12 mm cut): for seafood, fish and cocktails.

CDX40
 Stainless steel, ABS et HDPE



Réf.							
CDX4	39	19	40	2,1		Cut : 12 mm	
CDX7	39	19	40	2,1		Cut : 6 mm	
CDX47	39	19	40	4,5		Cut: 6 + 12 mm	

BLADE BLOC WITH HANDLES - LEMON CUTTER

¼ slice (6 mm cut): Mojito, Caïpirinha and Ti-punch, prepared three times faster.
 ½ slice (12 mm cut): for seafood, fish and cocktails.

Stainless steel, ABS, HDPE



Réf.			
CDX40	0,42	12 mm blade set with handles	CDX
CDX70	0,42	6 mm blade set with handles	CDX

APPLE CORER AND WEDGER

Cut in wedges and core the apple.

Stainless steel, ABS



Réf.							
CAX104P	38,5	32,5	58	3		4 wedges	
CAX106P	38,5	32,5	58	3		6 wedges	
CAX108P	38,5	32,5	58	3		8 wedges	

BLADES FOR APPLE CORER AND WEDGE CUTTER

Interchangeable for CAX high, low and apple versions. Caution: to use with suitable plunger : 4-8 or 6-12.

Stainless steel



Réf.			
CAX004	0,2	4 wedges	CAX
CAX006	0,2	6 wedges	CAX
CAX008	0,2	8 wedges	CAX
CAX012	0,2	12 wedges	CAX

SPARE BLADE FOR APPLE CORER AND WEDGE CUTTER

Interchangeable for CAX high, low and apple versions. Caution : use with suitable plunger : 4-8 or 6-12.

Stainless steel



Réf.			
CAX004P	0,09	4 wedges	
CAX006P	0,2	6 wedges	
CAX008P	0,2	8 wedges	

PUSHER FOR SECTIONS FOR WEDGE CUTTER

Robust and durable. Disassembles easily.

Stainless steel, ABS



Réf.							
CAX015	38	18	20	0,4		4 - 8 wedges	CAX104 / CAX108 / CAX204 / CAX208 / CAX104P / CAX108P
CAX016	38	18	20	0,57		6 - 12 wedges	CAX106 / CAX112 / CAX206 / CAX212 / CAX106P

KALI PROFESSIONAL APPLE PEELER AND SLICER

Slice: 4 mm. Peels, slices and cores apples.

- Fixing clamp
- Stainless steel blades, epoxy painted cast steel support



Réf.					
N4230	32	12,5	21	1,5	Manual

APPLE WEDGE CUTTER

Remove the core and cut into regular quarters in one step.

- Stainless steel



Réf.					
N4206	9	2,5	0,1		8 wedges
N4207	9	2,5	0,1		10 wedges

DOMESTIC APPLE PEELER - SUCTION BASE

To peel and empty the fruit without slicing it.

- With accessory without slicing
- Stainless steel blades, epoxy painted cast steel body



Réf.					
N4231	41	12	18,5	0,62	No slicing

APPLE PEELER - SUCTION BASE

Slice : 4 mm. Peels, slices and cores apples. Original model.

- Stainless steel blades, epoxy painted cast steel body



Réf.					
N4232T	23	10	14	0,9	Suction base

APPLE PEELER WITH TABLE CLAMP

Slice : 4 mm. Peels, slices and cores apples. Original model.

- Stainless steel blades, epoxy painted cast steel body



Réf.					
N4233	32	4	20	0,79	Clamp fixation

ALUMINIUM CHERRY STONER HULLER

- Aluminium



Réf.				
N4185	19,3	4,5	2,5	0,17

KALI PROFESSIONAL APPLE PEELER AND SLICER – MANUAL



Stainless steel blade
and **epoxy steel base**
for long-term use and durability
that stands the test of time

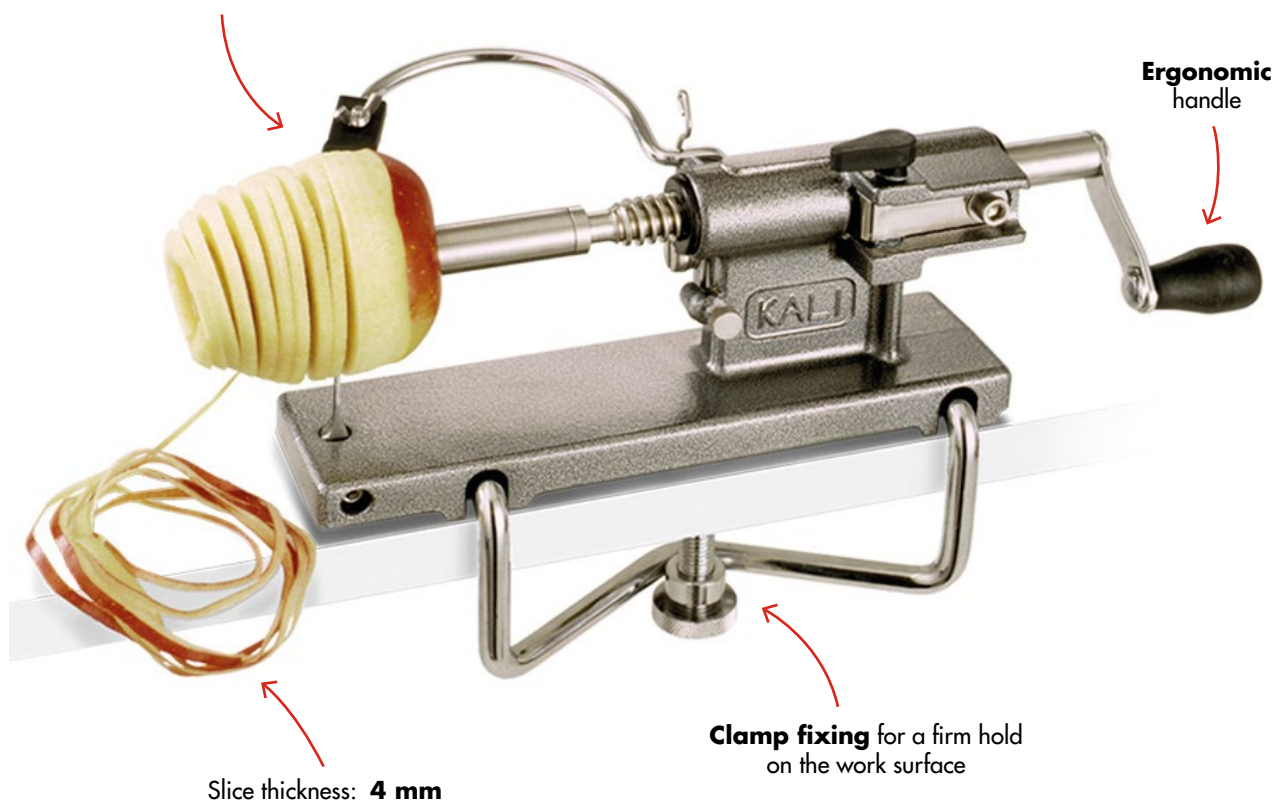

Ergonomic handle

Slice thickness: **4 mm**

Clamp fixing for a firm hold
on the work surface

This highly efficient apple peeler is designed to meet the high productivity demands of institutional catering services and restaurants alike: up to 40 kg of apples per hour.

PINEAPPLE PEELER



LOUIS TELLIER
RIEN NE REMPLACE LE FAIT MAIN

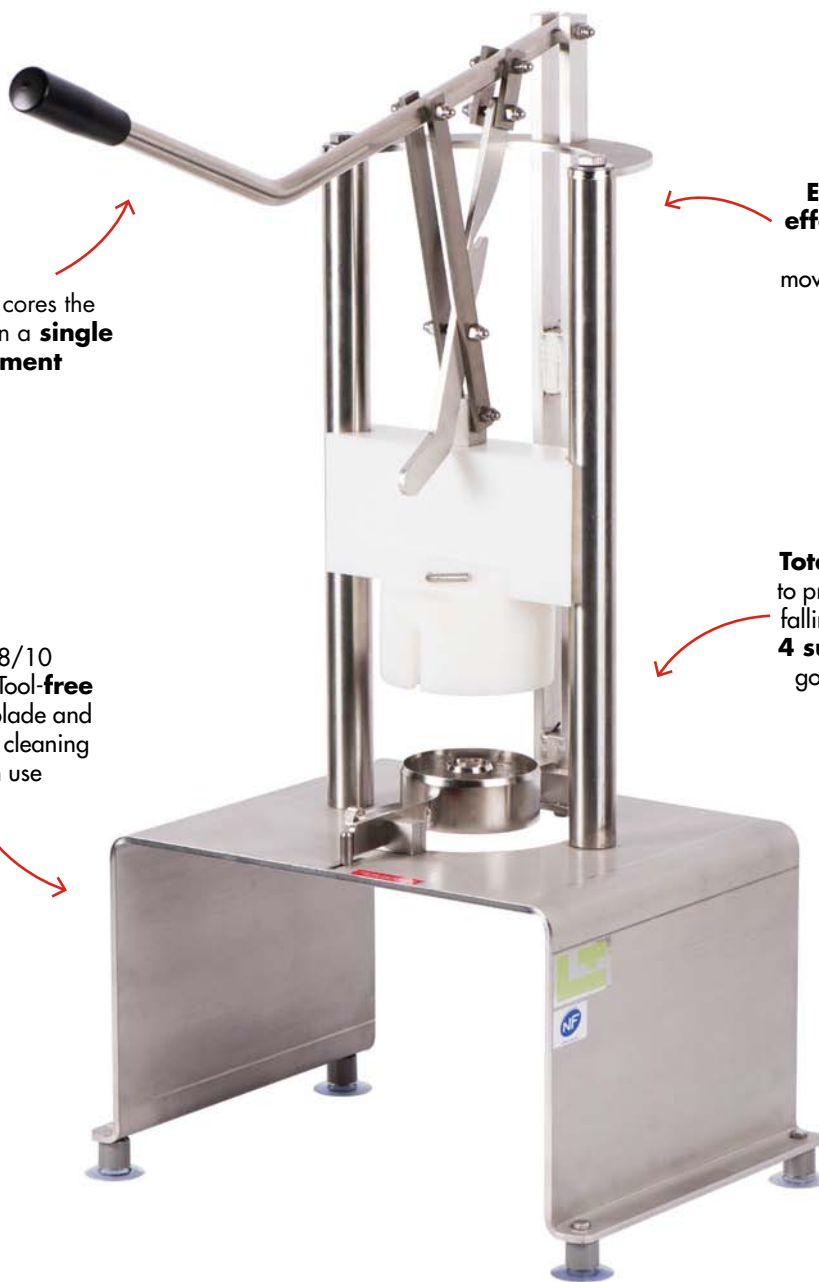
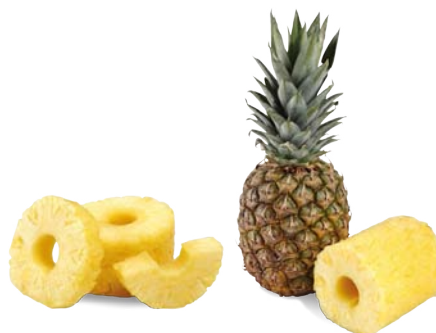

Peels and cores the pineapple in a **single movement**

Ergonomic and effortless working thanks to wide movement amplification

Made of 18/10 stainless steel. Tool-free **removal** of blade and push-piece for cleaning after each use

Total safety: system to prevent the push-piece falling over accidentally; **4 suction cups** ensure good contact with the work surface

This pineapple cutter cuts and cores in a single movement. It is tailored to the requirements of large-scale production, e.g. community catering and other catering.

6 accessories available.

PINEAPPLE PEELER

Peel and core the pineapple in only one movement. Security system. Use without physical effort. Dismantling of the blade and the pusher without any tool.

Stainless steel, HDPE



Réf.					
EA.	45	39	72	18	Ø 89 mm
EA095	45	39	72	18	Ø 95 mm
EA102	45	39	72	18	Ø 102 mm

ELECTRICAL PINEAPPLE PEELER

Constant and continuous working time. Secure system (action command with both hands). Waterproof IP66. Power supply 100/240V. Frequency 50/60 Hz. Power 29V / 45A.

Stainless steel



Réf.				
EA-EL	45	35	103	18,5

PINEAPPLE PEELER BLADE

Stainless steel



Réf.			
EA003	0,23	Ø 74 mm	EA/EA-EL
EA001	0,45	Ø 89 mm	EA/EA-EL
EA007	0,33	Ø 95 mm	EA/EA-EL
EA005	0,33	Ø 102 mm	EA/EA-EL

8 PARTS BLADE FOR PINEAPPLE PEELER

Stainless steel



Réf.		
EA013	8 parts	EA/EA-EL

MANGO BLADE FOR PINEAPPLE PEELER

Stainless steel



Réf.			
EA009	0,15	Mango	EA

PUSHER FOR PINEAPPLE PEELER

Robust and durable.

HDPE



Réf.			
EA004	0,37	Ø 74 mm	EA/EA-EL
EA002	0,48	Ø 89 mm	EA/EA-EL
EA008	0,55	Ø 95 mm	EA/EA-EL
EA006	0,59	Ø 102 mm	EA/EA-EL

8 PARTS PUSHER FOR PINEAPPLE PEELER

Robust and durable.

 HDPE



LT
LOUIS TELLIER

Réf.		
EA014	8 parts	EA

MANGO PUSHER FOR PINEAPPLE PEELER

Robust and durable.

 HDPE



LT
LOUIS TELLIER

Réf.			
EA010	0,52	Mango	EA

PINEAPPLE CORER

An easy, clean and quick cut of the heart. Dishwasher safe.

 Stainless steel



LT
LOUIS TELLIER

Réf.			
N4200	2,8	3	0,1

PINEAPPLE TOP AND TAIL CUTTER

Blade distance can be adjusted from 90 to 150 mm. Cuts both sides off the pineapple in one motion.

 2 curved blades, support

 Stainless steel, HDPE







Réf.				
N4210	33	22	20	5

PINEAPPLE SLICING GUIDE

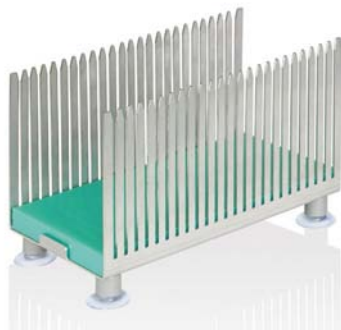
Cutting thickness : 1 cm.

 Stainless steel, HDPE



Réf.				
TR10	25,5	14	17	2,1

COCONUT CRAKER





Effortless. Place the coconut underneath the press and action. Ideal fresh cut.

 Stainless steel

 4-5 pcs / min.



LT
LOUIS TELLIER

Réf.				
N4212	13	38	19	11,8

WATERMELON WEDGE CUTTERS

To cut watermelons, round and oval melons into regular quarters. On a low work plan, clip the top, place the blades between the wires of the support, press firmly.

Stainless steel



Réf.					
SMP04	37	28	19,5	2	4 wedges
SMP06	35	28	24	2	6 wedges
SMP08	37	28	19,5	2	8 wedges

WATERMELON WEDGE CUTTER

To cut watermelons, round and oval melons into regular quarters. On a low work plan, clip the top, place on the columns, press firmly.

Stainless steel



Réf.					
N4215	50	60	40	7,5	4 parts. On demand.
N4214	50	60	40	9	6 parts. On demand.

MELON WEDGE CUTTER

To cut quickly round and oval melons into regular quarters. Guide columns.

SM006, SM008, 1 compatible support 6 and 8 cuts

Stainless steel, HDPE

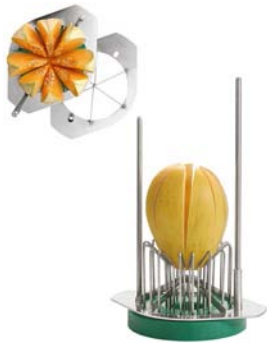

Réf.					
SM01	27	20	42	2,7	6 & 8 wedges
SM06	27	20	42	2,7	6 wedges
SM08	27	20	42	2,7	8 wedges

KNIFE FOR MELON WEDGE CUTTER

Interchangeable blades on the same support.

Stainless steel



Réf.						
SM006	27	20	7,5	0,5	6 wedges	SM01 / SM06 / SM08
SM008	27	20	7,5	0,6	8 wedges	SM01 / SM06 / SM08

TURN'UP® READY-TO-FILL SHELLS



LOUIS TELLIER
NE PAS REMPLACER LE TAIT WHISK



Cuts and cores
(cucumbers, potatoes, etc.)

Fill with dice-cut, minced, cheese, etc.



To make morsels with a bottom

3 models available
For cocktails*, dishes, desserts, etc.

The Turn'Up is a die-cutter for making regular bites with or without bottom.

The 3 sizes work in nesting to optimize the product and avoid the loss of raw material. Can be used for fruit and vegetables, potatoes, courgettes, melons, cucumbers, large carrots, turnips (previously blanched), etc.

* The cocktail turn'up includes a die-cutter and a knife to cut the bottom.

STAR-CUTTER

Sculpt fruit and vegetables with a single movement with its 5 steel blades! Ideal for egg, tomato and kiwifruit

Stainless steel, Tritan et ABS



Réf.			
CTE00	15	4	0,23

5 BLADES FOR STAR-CUTTER CTE00

Stainless steel et ABS



Réf.					
CTE01	4	3,5	2,7	0,02	5 blades for Star-Cutter CTE00

DECO SPOON

To be used vertically, perpendicular to the plate. To succeed every plate presentation with accuracy when working with liquid preparations (sauces, coulis, gravy, jus...).

2 spoons : 1 fine tip and 1 wide tip

Stainless steel spoon, silicone handle



Réf.					
PLU03M	22,5	6,5	2	0,07	Silicone handle

THAI CARVING KNIFE

For fruit and vegetable carving. Blade: 5.5 cm. Fine and soft blade. Pointer at the end of the handle.

Thin flexible tempered steel blade, bronze handle



Réf.				
ID1000	17	1,5	1,5	0,15

18 CARVING TOOLS + WHETSTONE

Suitable to make gorgeous fruit and vegetable carvings easily.

15 StS double chisels «U» & «V» shape + 3 StS stylus + 1 whetstone

Stainless steel



Réf.				
ID2500	20,5	7,5	3	0,25

DECORATION KIT WITH 22 CARVING TOOLS + WHETSTONE

Full panoply of fruit and vegetable carving tools. Kit with space for storage and transport.

4 fluted chisels + 6 rounded chisels + 4 bevelled chisels + 5 double chisels + 3 cutting blades + 1 whetstone.

Stainless steel



Réf.				
ID2580	30	17	4	0,4

TURN'UP

Creator of refined morsels! Cuts and cores. To make Morsels with bottom, to garnish with brunoise, minced meat, cheese...

Stainless steel



LOUIS TELLIER

Réf.			
TU01	5	0,31	∅ 5 cm
TU02	4	0,26	∅ 4 cm
TU03	3	0,18	∅ 3 cm

SET OF ROUND CUTTERS FOOD DESIGNER

St/St thickness: 0,6 mm. Creating aesthetically pleasing dishes that engage the taste buds is now easy with these round design culinary tools.

5 round cutters ∅ 5 - 10 - 15 - 20 - 25 mm + 3 pushers

Stainless steel



LOUIS TELLIER

Réf.					
ID1205	17	5,5	3,5	0,14	

SET OF SQUARE CUTTERS FOOD DESIGNER

St/St thickness: 0,6 mm. Creating aesthetically pleasing dishes that engage the taste buds is now easy with these square design culinary tools.

3 square pushers : 20x20 - 15x15 - 10x10 mm + 1 two-sided pusher.

Stainless steel



LOUIS TELLIER

Réf.				
ID1207	5,5	3,5	17	0,09

FRUIT AND VEGETABLE SCOOPS SET FOOD DESIGNER

Very useful to scoop out or core fruits and vegetables and turn them into balls. Features 6 sizes.

∅ : 5 / 10 / 15 / 20 / 25 / 30 mm

Stainless steel



LOUIS TELLIER

Réf.			
ID4100	0,5-1-1,5-2-2,5-3	2	0,12

RADISH DECORER

Radish flowers: decoration and morsel to fill.

Stainless steel



LOUIS TELLIER

Réf.				
N4197	16,5	5,1	1,9	0,24

PICKLE AND RADISH SLICER

8 blades. Clean and regular cut.

Stainless steel, PP



LOUIS TELLIER

Réf.				
N8008	17	2,5	2,5	0,03

VEGETABLE SHARPENER WITH HANDLE

Ø 3 cm introduction. Blade: 4 cm. To do vegetables flowers ! Ideal for courgettes, carrots...

Stainless steel, ABS



Ref.				
ID1100	3	3,8	0,05	Small size

VEGETABLE SHARPENER

Ø 5.5 cm introduction. Blade: 7 cm. To do vegetables flowers ! Ideal for courgettes, carrots...

Stainless steel, ABS



Ref.				
ID1101	5,5	7	0,15	Large size

CURL CUTTER

Bring originality with a wavy cut. Cut: 8.3 cm.

Stainless steel



Ref.				
ID4036	10,5	12,5	0,5	0,3

DECO-PINS

To make vegetables spiral with potatoes, turnip or carrots.

Stainless steel



Ref.				
N7105V	1,3	1,5	0,02	Loose

ELECTRIC MEAT GRINDER

With inverter switch.

3 sieves : Ø 3 - 5 - 8 mm - 3 funnels : Ø 12 - 18 - 21 mm. Kebbeh tip.

Stainless steel, acier, PP

60-80 kg/h

50 Hz - 350 W
220/240 V



Ref.				
N5600	43	18	42	6

BLADE FOR MEAT GRINDER

Stainless steel



Ref.		
N5600-C	0,042	N5600

SET OF SAUSAGE FUNNELS

Ø 12, 18, 21 mm.

PP



Ref.					
N5600-S	11	9	3	0,03	N5600

SIEVE FOR ELECTRIC MEAT GRINDER

Steel



Ref.						
N5600-03	7	7	0,7	0,12	Ø 3 mm	N5600
N5600-06	7	7	0,7	0,12	Ø 5 mm	N5600
N5600-08	7	7	0,7	0,12	Ø 8 mm	N5600

SIEVE FOR MEAT GRINDER - 8 BEAMS

Steel



Ref.					
N5600-07	7	7	0,7	0,12	N5600

SEMI-PROFESSIONAL ELECTRIC GRINDER N°5

Single-phased.

Ø53 mm sieve with Ø 6 mm holes

cast iron, plastic base

50 kg/h

50 Hz - 400W - 230 V



Ref.				
HV5-EL	39	20	25	6,9

SEMI-PROFESSIONAL ELECTRIC GRINDER N°12

Single-phased. Suitable for mincing pork grooves to make pâté and terrines.

 Ø70 mm sieve with Ø1,5 mm holes. 1 ring + 2 sausages funnels
Ø15 & 25 mm.





 cast iron, stainless steel base

 100 kg/h

 50 Hz - 500 W - 230 V

BEST SELLER



Réf. 
HV12-EL  50  30  32  13,25

SEMI-PROFESSIONAL ELECTRIC GRINDER N°22

Two-phased. With rotation reverser. Suitable for mincing pork grooves to make pâté and terrines.





 Ø82 mm sieve with Ø 8 mm holes + 1 crown

 cast iron, stainless steel base

 130 kg/h

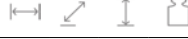
 50 Hz - 600 W - 230 V













Réf. 
HV22-EL  60  30  32  21

TOMATO SAUCE MILL OPTION

 Sieve with Ø 1.5 mm holes

 Grade 304 cast stainless steel and acetal resin body



Réf. 
HV1222-OPTCT  45  32  45  5,8  HV12-EL / HV22-EL
HV5-OPTCT  29  18  27  2,66  HV5-EL

MANUAL MEAT GRINDER











To be fixed on a table or work surface.

 Sieve: Ø6.5 mm

 Tinned cast aluminium, wooden handle

 1,15 kg/mn



Réf. 
N4022C  23,5  14  17,5  4  #22
N4032C  39  17  38  8,6  #32

SIEVE FOR MANUAL MEAT GRINDER

Steel



LA BONNE GRAINE

Réf.	⊖	↗	⊖	⊖	⊖	⊖
N40204C	8	8	1	0,21	∅ 4.5 mm	N4022C
N40206C	8	8	1	0,19	∅ 6.5 mm	N4022
N40208C	8	8	1	0,19	∅ 8 mm	N4022
N40212C	8	8	1	0,126	∅ 12 mm	N4022
N40215C	8	8	1	0,21	∅ 15 mm	N4022C
N40304C	10	10	1	0,32	∅ 4.5 mm	N4032C
N40306C	10	10	1	0,32	∅ 6.5 mm	N4032C
N40308C	10	10	1	0,29	∅ 8 mm	N4032C
N40312C	10	10	1	0,32	∅ 12 mm	N4032C
N40315C	10	10	1	0,33	∅ 15 mm	N4032C

SAUSAGE FUNNELS SET FOR MANUAL GRINDER

Diameter : 13 mm - 17 mm - 19 mm.
With crosspiece.

PP



Réf.	⊖	↗	⊖	⊖	⊖
N4022C-S	18	11	4,5	0,068	N4022C
N4032C-S	11	11	15	0,07	N4032C

KNIFE FOR MANUAL MEAT GRINDER

Steel

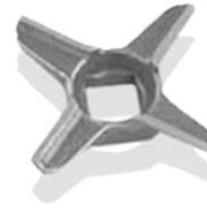

Réf.	⊖	↗	⊖	⊖	⊖
N40221C	7	7	1,5	0,8	N4022C
N40321C	8,5	8,5	2	0,98	N4032C

3,5L MANUAL SAUSAGE STUFFER

2 pastic coated fixing clamps. Get locked by a « clic » of locking. Inside leakproof silicone-coated pusher. 2 positions: vertical to fill up the tank and horizontal to stuff.

3,5 L

4 funnels: ∅ 17-21-25-29 mm

Stainless steel tank and epoxy painted base



Réf.	⊖	↗	⊖	⊖
N5900	44	27	18	4,5

MANUAL HORIZONTAL SAUSAGE STUFFER

No addition of air: optimal preservation of the quality of the meat.

4 funnels : Ø 15/23/28/38 mm

Painted steel and stainless steel



Réf.	↔	↗	⊥	📦	🔍
PSX05	60	22	22	10,6	5L
PSX08	70	22	22	11,95	6.7 L

SET OF 3 FUNNELS

Ø 15 - 20 - 23 mm.

PP



Réf.	↔	↗	⊥	📦	🔍
N4047CXE	16	10	5	0,05	N4047C / N4047CX

SET OF 3 SAUSAGE FUNNELS

Three different sizes : 9 - 17 - 27 mm in diameter.

PP



Réf.	📦	🔍
N5700-S	0,06	N5700

2L MANUAL SAUSAGE STUFFER

To make sausages and blood sausages. Capacity : 2 L. Supplied with three funnels. To be bolted.

2 L

3 funnels : Ø 14 mm - 18 mm - 22 mm

Cast steel



Réf.	↔	↗	⊥	📦
N4047C	22	12,5	24,5	6,1

VERTICAL MANUAL SAUSAGE STUFFER

To make sausages and blood sausages. Supplied with three funnels. To be bolted. Dimensions of the base: 30 x 22 cm.

3 L

3 funnels : Ø 0.9 - 1.7 - 2.7 cm

Stainless steel tank and epoxy frame



Réf.	↔	↗	⊥	📦
N5700	30	58	71	6,2

VERTICAL ST/ST MANUAL SAUSAGE STUFFER

To be bolted. Dimensions of the base: 30 x 22 cm. 2 speed rack gearing.

3 L

3 funnels : Ø 14 - 20 - 30 mm

Stainless steel







Réf.	↔	↗	⊥	📦
N5750	42	42	76	8,6

SET OF 3 SAUSAGE FUNNELS

Three different sizes : 14 - 20 - 30 mm in diameter.

 Stainless steel



Ref.					
N5750-S	6	6	19	0,26	N5750

SAUSAGE STAND

Ø top : 8 cm. Ø base: 28 cm.

 Stainless steel



Ref.				
NC006	28	28	3,5	0,56

TERRINE-PRESS HACCP

Adaptable on all types of terrines dishes, frames, circles, gastro trays... For terrines after cooking: foie gras, calf sweetbreads, marbled, salted meat before smoking. Simultaneous and identical pressure on all its surface.

 Stainless steel



Ref.				
PRESTE01	15	10	18	0,92

DUCK PRESS

To make the Blood Duck recipe.

 Tinned pot

 Brass



Ref.			
NY100	52	16	Bronze. On demand.
NY300	52	16	Chrome. On demand.

SPÄTZLE SIEVE - DOMESTIC MODEL

Suitable for pots and saucepans Ø from 22 to 26 cm. Holes Ø 8 mm. Detachable, dish-washer safe. To prepare short Spaetzles and Knepfles, regional specialties in Alsace, Lorraine and Central Europe. Fill the dough reservoir and move back and forth over the pot of boiling water.

Locking notch for the edge of the saucepan/pot

Stainless steel



Ref.				
N8006	33,5	11	7	0,37

PROFESSIONAL SPÄTZLE SIEVE

Suitable for pots and saucepans > Ø 40 cm. Grid 39.5 x 9 cm, holes Ø 8 mm. Sliding reservoir on HDPE Strong, detachable, dish-washer safe. To prepare short Spaetzles and Knepfles, regional specialties in Alsace, Lorraine and Central Europe. Fill the dough reservoir and move back and forth over the pot of boiling water.

1,3L

Locking notch for the edge of the saucepan/pot

Stainless steel, PE



Ref.				
SP01	85	14	18,5	1,7

ATLAS MANUAL PASTA MACHINE

Ajustable thickness: 10 ranks from 4.8 mm to 0.6 mm. Manual 10 thicknesses rolling mill and 2 accessories.

Double detachable attachment tagliolini 1.5 mm and fettuccine 6 mm, clamp.

Chrome steel, anodized aluminium rollers, Tempered steel gears, steel and plastic handle



Ref.					
N8001	34	20,5	29	2,6	Dough width 150 mm

ATLAS ELECTRIC PASTA MACHINE

Dough width 150 cm. Ajustable thickness: 10 ranks from 4.8 mm to 0.6 mm. Electric 10 thicknesses rolling mill and 2 accessories.

Atlas 150, motor, crank, double detachable attachment fettuccine 6 mm and tagliolini 15 mm, clamp

Chrome steel, anodized aluminium rollers and Tempered steel gears

50/60 Hz - 100 W - 220/240 V



Ref.				
N8005	34	20	18	4,5

«PASTADRIVE» MOTOR FOR ATLAS

To motorize Atlas pasta machines.

ABS

50/60 Hz - 100 W - 220/240 V



Ref.					
N8001-E	13	17,5	11	1,25	N8001 / N8005-110 / N7995 / N7994 / N79941 / N8000 / N8005 / N7993 / N3013.

RAVIOLI ACCESSORY FOR ATLAS

3 cavities 45 x 45 mm.

Spoon tip to pour stuffing

PS, ABS, chrome steel



Ref.						
N8004	18	11,5	9	1,45	Ravioli	N8001 / N8005 / N7994 / N79941.

SPAGHETTI ACCESSORY FOR ATLAS

Round cut Ø 2 mm. Compatible with electric and manual Atlas 150 machines.

Anodized aluminium, chrome steel



Ref.						
N8003	17	7	4,5	0,6	Spaghetti	N8001 / N8005 / N7994 / N79941.

PROFESSIONAL ELECTRIC PASTA MACHINE CHEF IN CASA

Professional use. Several choice of pastas: 13 bronze drawplates option. Kneading machine, rolling mill and extruder-drawing. Old-fashioned pasta's flavor and texture.

2 kg

Bronze drawplate (170 mm-wide) + manual rotating pasta-cutter knife N7917-01

External structure in anodized aluminum, bronze dies, stainless steel mixer

6-8 kg / h

50 Hz - 750 W - 230 V



Ref.						
N7917	29	55	30	3	On demand	

CHEF IN CASA MANUAL KNIFE

To cut pastas at Chef in Casa output. Ajustable lenght according to rotation speed.

ABS, anodised aluminium, stainless steel



Ref.						
N7917-01	15	14	10	1,2	Manual. On demand.	N7917

CHEF IN CASA ELECTRIC KNIFE

Allows continuous production. To cut pastas at Chef in Casa output. Ajustable length according to rotation speed.

ABS, anodised aluminium, stainless steel



Ref.						
N7917-02	27,5	7	8	2,1	Electric. On demand.	N7917

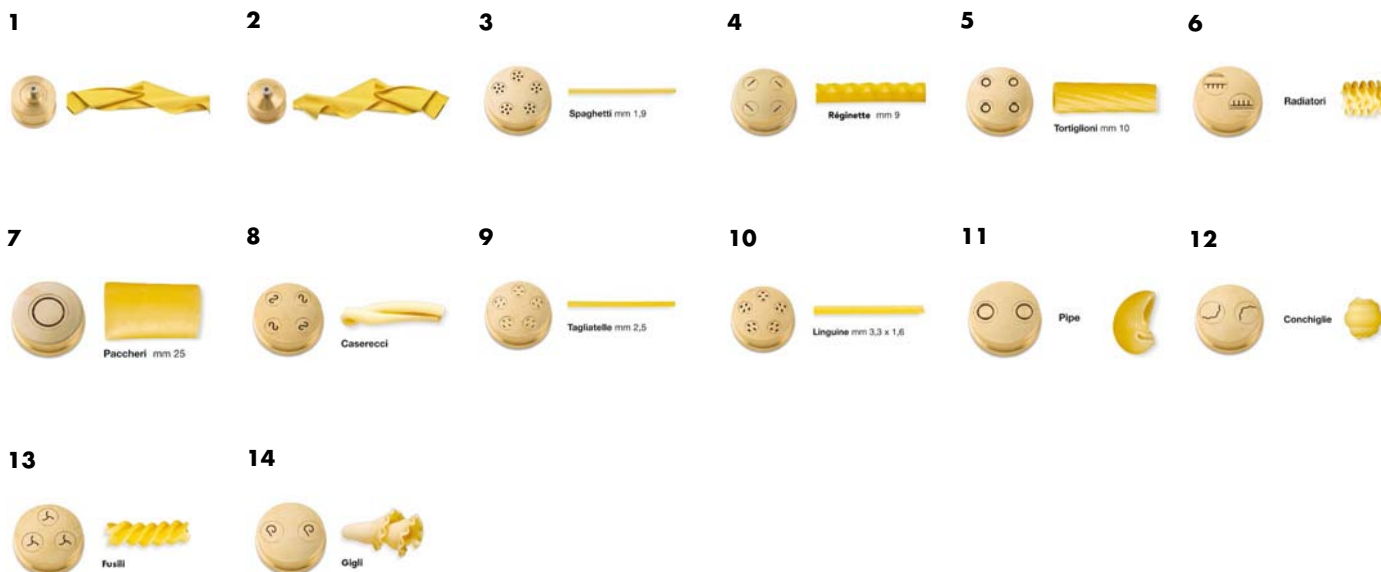

Réf.

1 CHEF IN CASA BRONZE DRAWPLATE (INCLUDED)

Supplied with N7917 appliance. Pasta sheet in stripe.

N7917-03	0,4	100 mm.	On demand.	N7917
----------	-----	---------	------------	-------

2 CHEF IN CASA BRONZE DRAWPLATE

Width fits to N7899 ravioli machine. Pasta sheet in stripe.

N7917-04	0,4	170 mm.	On demand.	N7917
----------	-----	---------	------------	-------

3 CHEF IN CASA BRONZE DRAWPLATE - SPAGHETTI

Traditional wire drawing in bronze, guaranteeing rough pasta, which better retain the sauces.

N7917-05	27,5	8	8	0,3	Spaghetti. On demand.	N7917
----------	------	---	---	-----	-----------------------	-------

4 CHEF IN CASA BRONZE DRAWPLATE - REGINETTE

Traditional wire drawing in bronze, guaranteeing rough pasta, which better retain the sauces.

N7917-06	0,3	Reginette.	On demand.	N7917
----------	-----	------------	------------	-------

5 CHEF IN CASA BRONZE DRAWPLATE - TORTIGLIONI

Traditional wire drawing in bronze, guaranteeing rough pasta, which better retain the sauces.

N7917-07	15	12	10	0,3	Tortiglioni. On demand.	N7917
----------	----	----	----	-----	-------------------------	-------

6 CHEF IN CASA BRONZE DRAWPLATE - RADIATORI

Traditional wire drawing in bronze, guaranteeing rough pasta, which better retain the sauces.

N7917-08	0,3	Radiatori.	On demand.	N7917
----------	-----	------------	------------	-------

7 CHEF IN CASA BRONZE DRAWPLATE - PACCHERI

Traditional wire drawing in bronze, guaranteeing rough pasta, which better retain the sauces.

N7917-09	0,3	Paccheri.	On demand.	N7917
----------	-----	-----------	------------	-------

8 CHEF IN CASA BRONZE DRAWPLATE - CASERECCI

Traditional wire drawing in bronze, guaranteeing rough pasta, which better retain the sauces.

N7917-10	0,3	Caserecci.	On demand.	N7917
----------	-----	------------	------------	-------

Réf.

9 CHEF IN CASA BRONZE DRAWPLATE - TAGLIATELLE

Traditional wire drawing in bronze, guaranteeing rough pasta, which better retain the sauces.

N7917-11	14	14	12	0,3	Tagliatelle. On demand.	N7917
----------	----	----	----	-----	-------------------------	-------

10 CHEF IN CASA BRONZE DRAWPLATE - LINGUINE

Traditional wire drawing in bronze, guaranteeing rough pasta, which better retain the sauces.

N7917-12	0,3	Linguine.	On demand.	N7917
----------	-----	-----------	------------	-------

11 CHEF IN CASA BRONZE DRAWPLATE - PIPE

Traditional wire drawing in bronze, guaranteeing rough pasta, which better retain the sauces.

N7917-13	0,3	Pipe.	On demand.	N7917
----------	-----	-------	------------	-------

12 CHEF IN CASA BRONZE DRAWPLATE - CONGHIGLIE

Traditional wire drawing in bronze, guaranteeing rough pasta, which better retain the sauces.

N7917-14	0,3	Conghiglie.	On demand.	N7917
----------	-----	-------------	------------	-------

13 CHEF IN CASA BRONZE DRAWPLATE - FUSILLI

Traditional wire drawing in bronze, guaranteeing rough pasta, which better retain the sauces.

N7917-15	0,3	Fusilli.	On demand.	N7917
----------	-----	----------	------------	-------

14 CHEF IN CASA BRONZE DRAWPLATE - GIGLI

Traditional wire drawing in bronze, guaranteeing rough pasta, which better retain the sauces.

N7917-16	0,3	Gigli.	On demand.	N7917
----------	-----	--------	------------	-------

IMPERIA PASTA MACHINES - RESTAURANT MODEL

Pasta sheet width: 21 cm. Adjustable thickness: 10 ranks from 5 mm to 0 mm. Half-professional 10 thicknesses rolling mill. Possibility to accessorize with 7 types of pasta drawplates (including lasagne). Small catering.

Special self-lubricating rollings to reduce stress

Chrome steel, tempered steel gear

12 kg/h



Réf.					
N7900	32,5	22	27,5	9,3	Manual
N7932	31	25,5	31		Electronic
N7933	30	22	25	14,75	Electric

ACCESSORIES FOR IMPERIA PASTA MACHINE - RESTAURANT MODEL

Compatible with electric and manual Imperia Restaurant machines.

Chrome steel



Réf.						
N7900-01	28,5	8	9	2	Spaghetti Ø 2 mm. On demand.	N7900 / N7923 / N7922
N7900-02	29	9,5	10	2	Angel hair 1.5 mm. On demand.	N7900 / N7923 / N7922
N7900-03	29	8	10	2	Tagliatelles 2 mm. On demand.	N7900 / N7923 / N7922
N7900-04	17,5	4,5	5	2,14	Reginette - lasagnette 12 mm. On demand.	N7900 / N7923 / N7922
N7900-05	29	6,5	7	2,09	Fettuccine 6,5 mm. On demand.	N7900 / N7923 / N7922
N7900-06	29	8	9	2,09	Lasagnette 12 mm. On demand.	N7900 / N7923 / N7922
N7900-07	30	9	8	2,18	Trenette. On demand.	N7900 / N7923 / N7922

CHROME I PASTA 150 MANUAL PASTA MACHINE

Pasta width 150 mm. Adjustable thickness: 6 ranks from 2.2 mm to 0.2 mm. Manual rolling mill 6 thicknesses and 2 accessories.

Removable double accessory tagliatelle 2 mm and fettuccine 65 mm, clamp, dough support tray

Chrome steel, wooden handle



Réf.					
N7905	34	11,5	13	2,84	Chromed

I PASTA 150 MANUAL PASTA MACHINE - RED

Pasta width 150 mm. Adjustable thickness: 6 ranks from 2.2 mm to 0.2 mm. Manual rolling mill 6 thicknesses and 2 accessories.

Removable double accessory tagliatelle 2 mm and fettuccine 6.5 mm, clamp, dough support tray.

Chrome steel, wooden handle



Réf.					
N7905R	34	11,5	13	2,84	Red

ENGINE « PASTA FACILE »

2 speeds. To motorize the I Pasta machines and the Ravioli and Gnocchi accessories.

ABS

50 Hz - 80 W - 220/240 V



Réf.						
N7905-E	18,5	11	13	1,31	On demand	N7905 / N7905R / N7903 / N7908 / N7905-01 / N7905-11 / N7905-07.

ELECTRIC PASTA MACHINE IMPERIA 150

Pasta width 150 mm. Adjustable thickness: 6 ranks from 2.2 mm to 0.2 mm. Electric rolling mill 6 thicknesses and 2 accessories.

I Pasta machine, motor, crank, double amovible accessory tagliatelles 2 mm and fettuccine 6.5 mm, clamp.

Chrome steel, ABS

50 Hz - 80 W - 220/240 V



Réf.				
N7906	47	11,5	13	2,5

MOTORIZABLE ACCESSORIES BY N7905-E

Ravioli 5x5 mm

Pasta scraper (adapted to the pasta sheet width), brush.

Aluminium, ABS, wood, chrome steel



Ref.						
N7905-01	15	14	10	1,43	Ravioli 5x5 mm - 2 cavities	N7906 / N7905 / N7905R / N7903 / N7908.

MOTORIZABLE ACCESSORIES BY N7905-E

To make gnocchi.

3 cavities : gnocchetti sardi, cavatelli and rigatelli.

Pasta scraper (adapted to the pasta sheet width), brush.

Aluminium, ABS, wood, chrome steel



Ref.						
N7905-07	15	12	10	1,16	Gnocchi	N7906 / N7905 / N7905R / N7903 / N7908.

MOTORIZABLE ACCESSORIES BY N7905-E

To make ravioli or gnocchis.

Pasta scraper (adapted to the pasta sheet width), brush.

Aluminium, ABS, wood, chrome steel



Ref.						
N7905-11	14	14	12	1,43	Ravioli 3x3 mm - 3 imprints	N7906 / N7905 / N7905R / N7903 / N7908.

I PASTA 150 ACCESSORIES

Compatible with electric and manual Atlas 150 machines.

Chrome steel



Ref.						
N7905-02	27,5	7	8	0,81	Lasagnette of 12 mm	N7906 / N7905 / N7905R / N7903 / N7908.
N7905-03				0,73	Reginette of 12 mm	N7906 / N7905 / N7905R / N7903 / N7908.
N7905-04				0,81	Trenette of 4 mm	N7906 / N7905 / N7905R / N7903 / N7908.
N7905-05	27,5	8	8	0,8	Capelli d'angelo of 15 mm	N7906 / N7905 / N7905R / N7903 / N7908.
N7905-06				0,8	Spaghetti of 2 mm	N7906 / N7905 / N7905R / N7903 / N7908.

I PASTA 150 ACCESSORIES

Compatible with electric and manual Atlas 150 machines.

Chrome steel



Ref.			
N7905-08	0,77	Pappardelle of 32 mm	N7906 / N7905 / N7905R / N7903 / N7908.

PASTA DRYING RACK

Up to 1 kg of pasta. 12 bars to dry your pastas freshly cut.

Beechwood



Ref.				
N7907	30	30	33	0,57



Wooden rolling pin
 Stamped aluminium, enamelled steel base, rubber feet



Réf.

1 RAVIOLI MOULD - 36 CAVITIES

Ravioli: 3.4 x 3.4 cm. Full range of ravioli and ravioles moulds.

N7910	30	10	9	0,32	Raviolis 3.4 x 3.4 cm
-------	----	----	---	------	-----------------------

2 RAVIOLI MOULD - 44 CAVITIES

Ravioli: 2.5 x 2.5 cm. Full range of ravioli and ravioles moulds.

N7911	29	10,5	1	0,23	Raviolis 2.5 x 2.5 cm
-------	----	------	---	------	-----------------------

Réf.

3 RAVIOLI MOULD - 18 CAVITIES

Side: 60 mm. Full range of ravioli and ravioles moulds.

N7912	35,5	11,5	2	0,3	Raviolis 6 x 6 cm
-------	------	------	---	-----	-------------------

4 RAVIOLI MOULD - 12 CAVITIES

Ravioli: 5.5 x 5.5 cm. Full range of ravioli and ravioles moulds.

N7913	33,5	11,5	2	0,31	Raviolis 5.5 x 5.5 cm
-------	------	------	---	------	-----------------------

WOODEN ROUND PIZZA LIFTER

Beech shovel to put and take out of the oven pizzas and breads. Base 22x27 mm.

Beechwood



LOUIS TELLIER

Réf.				
NPB28	28	1,56	1	Ø 28 cm - handle 1.25 cm
NPB33	33	2,3	1,4	Ø 33 cm - handle 2 m
NPB40	40	2,3	1,85	Ø 40 cm - handle 2 m

ST/ST SQUARED PIZZA LIFTER

Base 32x32 cm. Handle 96.5 cm. St.S. shovel to put and take out of the oven pizzas and breads.

Stainless steel



LOUIS TELLIER

Réf.				
NPX30	127,03	32	1,2	Square

ST/ST ROUND PIZZA LIFTER

Base Ø 32 cm. Handle 96.5 cm. St.S. shovel to put and take out of the oven pizzas and breads.

Stainless steel



BEST SELLER



LOUIS TELLIER

Réf.			
NPX31	32	1,2	Round

PIZZA CUTTER

Wooden handle



Réf.			
N3702	10	3	0,19

GUITAR WITH WIRE



LOUIS TELLIER

RIEN NE REMPLACE LE FAIT MAIN



Made in France

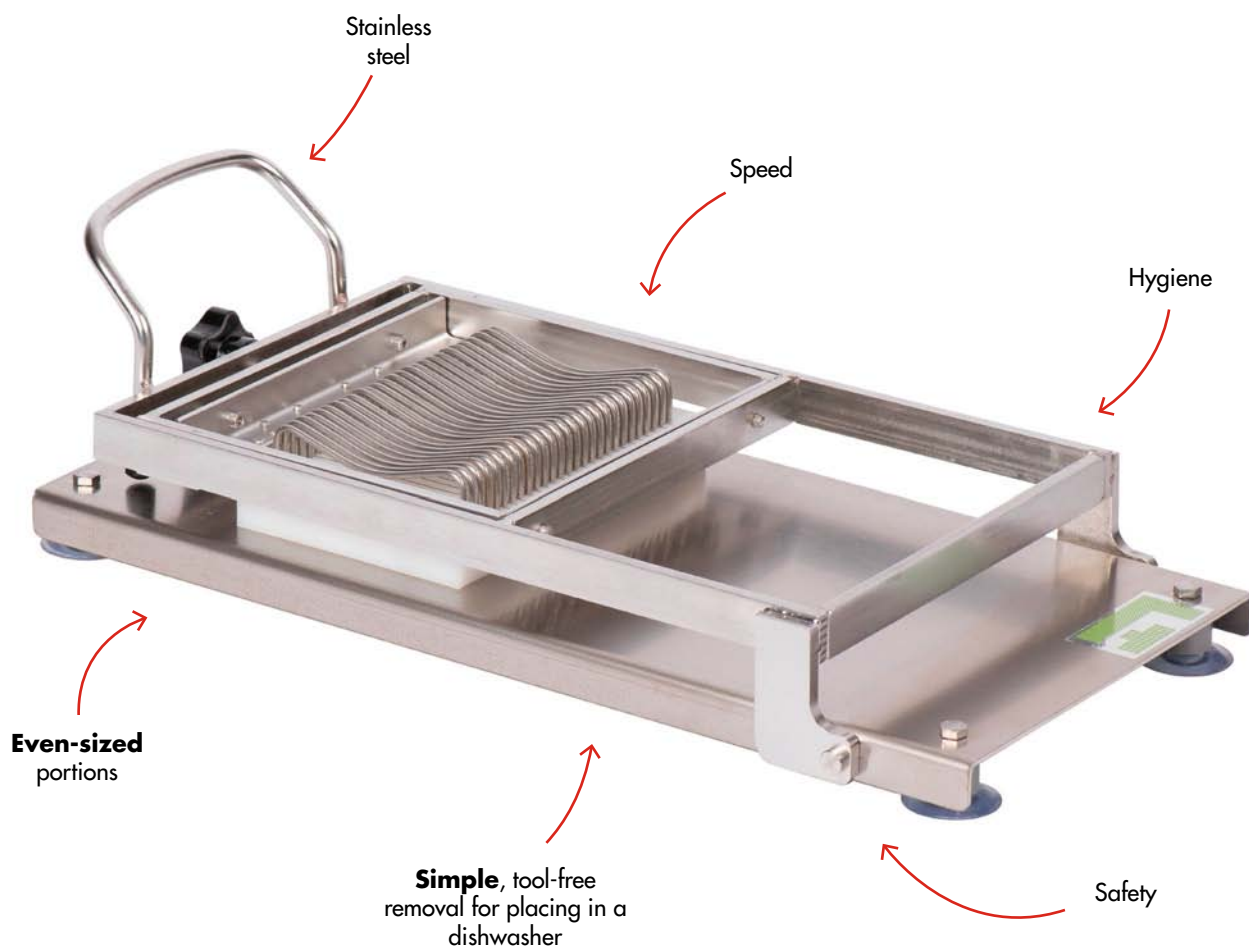
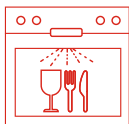

CULINARY PREPARATION

For foie gras, mousses, soft fruits, cheese, mozzarella, feta, butter, hard-boiled eggs, sausages, beetroots, etc., i.e. all products that are of soft and even consistency.

2 sizes: mini (cutting length: 14.5 cm) or maxi (30 cm) fitted with a choice of:

- a hollow holder for round products,
- a flat holder for flat products,
- choice of cutting width: 5, 7, or 10 mm.

MINI GUITAR FOR ROUND PRODUCTS

Clean and regular cut. Cutting length : 14.5 cm.

Stainless steel



LOUIS TELLIER

Réf.					
GX01	45,5	23,3	13,5	4,9	5 mm slices
GX03	45,5	23,3	13,5	4,9	10 mm slices

MINI GUITAR FOR FLAT PRODUCTS

Cutting length : 14,5 cm.

Stainless steel



LOUIS TELLIER

Réf.					
GX02	45,5	23,3	13,5	4,9	5 mm slices
GX04	45,5	23,3	13,5	4,9	10 mm slices

ROUND HOLDER FOR MINI GUITAR

Stainless steel



LOUIS TELLIER

Réf.			
GX012	0,65	5 mm Round holder	GX01 / GX02
GX014	0,65	10 mm Round holder	GX03 / GX04
GX022	0,65	5 mm Flat holder	GX01 / GX02
GX024	0,65	10 mm Flat holder	GX03 / GX04
GX052	0,32	7 mm Round holder	GX05 / GX06
GX053	0,32	7 mm Flat holder	GX05 / GX06

MAXI GUITAR FOR FLAT PRODUCTS

Clean and regular cut. Cutting length : 30 cm.

Stainless steel

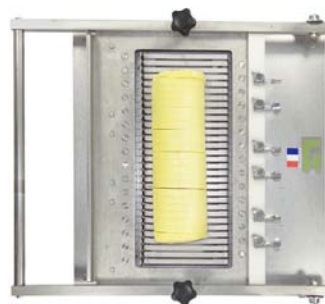

LOUIS TELLIER

Réf.					
GXM06	49	43,8	9,4	7,6	7 mm slices
GXM04	49	43,8	9,4	7,6	10 mm slices

MAXI GUITAR FOR ROUND PRODUCTS

Clean and regular cut. Cutting length: 30 cm.

Stainless steel



LOUIS TELLIER

Réf.					
GXM03	49	43,8	9,4	8,9	10 mm slices
GXM05	49	43,8	9,4	8,9	7 mm slices

ROUND HOLDER FOR MAXI GUITAR

Stainless steel



LOUIS TELLIER

Réf.			
GXM012	0,7	10 mm Round holder	GXM03 / GXM04
GXM022	0,94	10 mm Flat holder	GXM03 / GXM04
GXM052	0,62	7 mm Round holder	GXM05 / GXM06
GXM053	0,85	7 mm flat holder	GXM05 / GXM06

SPARE GUITAR WIRES FOR MINI GUITAR

Replacement wires for mini guitar model.

Stainless steel



Réf.			
GX015-2	0,04	0,05	8 x 2 wires
GXM015-2	0,04	0,08	4 x 6 wires

CAMEMBERT WEDGE CUTTER

Cut : Ø 15 cm. Equal portions in a move. Easy cleaning.

Stainless steel, HDPE



Réf.					
PF01	27	20	26	2,5	6 & 8 portions
PF06	27	20	26	2	6 portions
PF08	27	20	26	2	8 portions

CHEESE AND FOIE GRAS SLICER WITH WIRE AND BOARD

Cutting width : 14 cm. For foie gras, butter, goat cheese and blue cheeses.

Stainless steel



Réf.				
N3506	27	22,5	3	0,63

TERRINE SLICER

Cutting width: 13 cm. Cutting length: 30 cm.

Stainless steel



Réf.					
CTER01	57	22	22,5	7,6	Cut 10 mm
CTER02	57	22	22,5	7,6	Cut 7 mm

TRADITIONAL CHEESE GIROLLE ROTARY GRATER

Cut: Ø 17 cm. The original.

Certified FSC maple wooden base

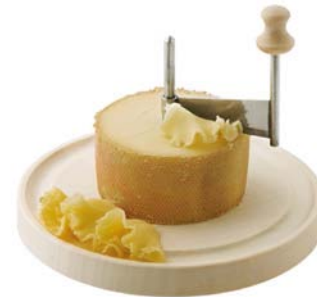

Réf.				
N3027	22	15,5	0,8	

SET OF 5 SPARE WIRES FOR CHEESE CUTTER

Stainless steel



Réf.					
N35061	22	12	0,1	0,3	N3506

LYRE

Perfect to cut foie gras, butter, goat's cheese, cheeses with parsley etc.

Stainless steel



Réf.				
N3500	12	12,5	0,1	
N3503		17	21	0,17
N3504		21	26	0,2

SET OF 10 SPARE WIRES

Stainless steel

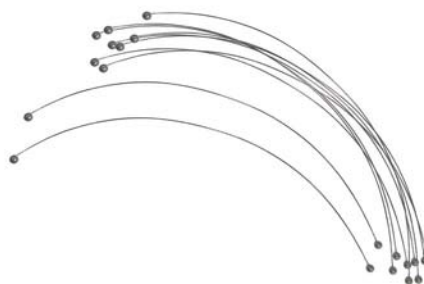

Réf.			
N35031	17	0,01	N3503
N35041	21	0,01	N3504

SET OF 10 CHEESE WIRES

Allows the cutting of cheese, butter and foie gras.

Stainless steel, PP



Réf.		
N3515	60	0,16

FINE GRATER

On stand for better stability. For chocolate, parmesan, etc.

Stainless steel



Réf.				
300RP	40	13,5	4	0,9

HAND FREE CHEESE GRATER

SAN, PP, HDPE, stainless steel



ONE-TOUCH

Réf.			
KRFA01	5,4	18	0,36

NUTMEG GRATER

Tank

Stainless steel



Réf.				
N4190	4,5	2,6	14	0,03

EGG TOP CUTTERS



LOUIS TELLIER



Precision cutting of raw or hard-boiled eggs

Stainless steel

Efficient: ensures that the shell is opened **cleanly** and **precisely**

Cutting Ø: 3.5 cm

Hygienic: provides a **clean** and **easy** solution for topping eggs

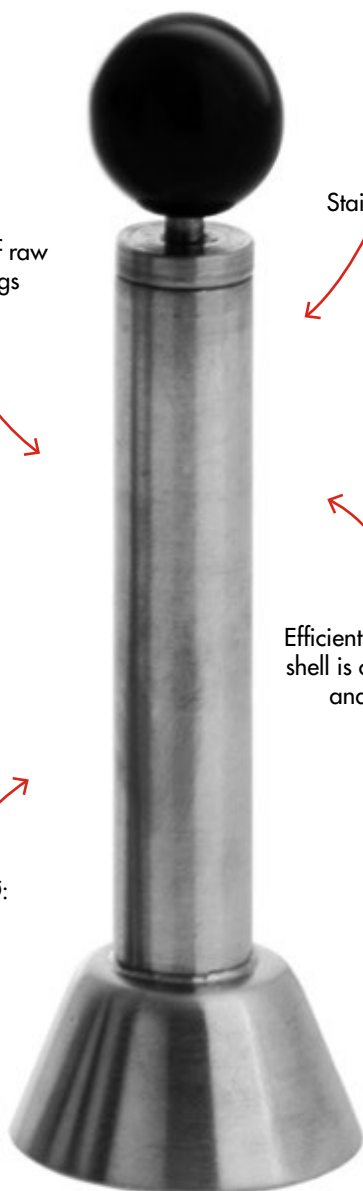

Gastronomic chefs and caterers also use it for creative cooking: once the shell has been emptied, it becomes an original container for scrambled eggs with truffles, eggs with a chocolate garnish, etc. Infinite possibilities for creating menus that are tempting for eyes and tastebuds alike.

EPOXY EGG SLICER

 Epoxy painted cast aluminum







Ref.				
N4184	13,5	8	3,3	0,15

ST/ST EGG SLICER

 Stainless steel



Ref.				
N4184X	16	8,5	2	0,2

EGG WEDGE CUTTER

6 sections. For your salads, your dishes or as a decoration.

 Stainless steel



Ref.				
N4188X 	21	6,5	2,5	0,13

PROFESSIONNAL EGG SEPARATOR

Designed to be installed on a 1/4 GN container.

 Stainless steel

 1 000 pcs /h



Ref.				
SPOE01	30,5	10	10,5	0,5

EGGS TOP CUTTER

Cutting Ø: 3 cm. The ultimate tool to quickly and accurately remove the top of raw or soft-boiled eggs.

 Stainless steel



Ref.			
N4183	3	11	0,7

BREAD SLICER WITH PROTECTION



LOUIS TELLIER
BIEN NE REMPLACE LE FAIT MAINT



Cuts regular, perfect slices without crushing, even with loaves and baguettes out of the oven.

Models available with wooden base and HACCP high-density polyethylene base.

Note: the use of cut-resistant gloves is strongly recommended.

BREAD SLICER WITH ROUND BLADE

Perfect cutting without crushing. Even slices. Toothed blade with a 25-cm half-moon profile. Adjustable stop for slices from 5 to 85 mm. Security casing for finger protection. Stabilising suckers.

Tempered st/st blade



Réf.					
703SF1	22	39	25	3,4	Wooden base
703SF1P	22	39	25	3,4	HACCP HDPE base
703SX	22	39	25	3,4	HACCP St/st base

BREAD SLICER WITH ST/ST BASE

Straight blade of 35 cm. Guillotine result: efficient cut.

Safety casing for finger protection. Anti-slip pads.

Tempered st/st blade



Réf.				
35CPX	53	13	16	2,3

BREAD SLICER WITH WOODEN BASE

Straight blade of 35 cm.

Wooden base and tainless steel blade



Réf.				
N7004	40	11	15	2,2

BREAD SLICER WITH WOODEN BASE - ECONOMIC PRICE

Straight blade of 25 cm.

Wooden base and stainless steel blade



Réf.				
N7013	40	12	7,5	0,94

BAGUETTE SLICER

Short blade : cut in 2. Safety first: avoid getting cut. Easy and quick to use: push the 1/2 baguette in from one side, and pull it out at the other.

Clamp fixation

Stainless steel



Réf.					
FVX1	19,5	6	22,5	1,14	Sandwiches

TORTILLA WEDGE CUTTER

Stainless steel



Réf.				
TORT06	25	21	0,25	6 wedges
TORT08	25	21	0,25	8 wedges

HACCP COLORS



Yellow: raw poultry



Violet: non-allergenic foods (e.g. gluten-free)

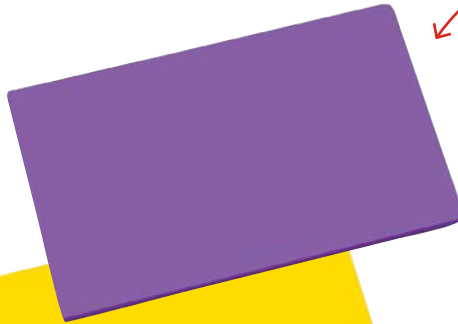

Green: fruit and vegetables



Red: raw meat



Blue: raw fish and seafood



Brown: cooked meat and charcuterie



White: dairy products, bread, cheese, pastry



Colour-coded chopping boards that comply with the HACCP approach: one colour for each type of food, to avoid cross-contamination.

HDPE 500 CUTTING BOARD - BLACK

GN 1/1. Perfect for the bar.

HDPE



LOUIS TELLIER

Ref.				
NPP11-N	53	32,5	2	3

HDPE 500 CUTTING BOARD WITH JUICE GROOVE - WHITE

Special HACCP color for dairy products, bread and pastries. With juice groove. Superior quality.

HDPE



BEST SELLER

LOUIS TELLIER

Ref.				
NPP41	40	30	2	1,5
NPP51	50	30	2	3
NPP61	60	40	2	4,65

HDPE 500 CUTTING BOARD - WHITE

Superior quality. Special HACCP color for dairy products, bread and pastries.

HDPE

BEST SELLER



LOUIS TELLIER

Ref.				
NPP4	40	30	2	1,5
NPP5	50	30	2	3
NPP6	60	40	2	4,65

INJECTED PE CUTTING BOARD - WHITE

Special HACCP color for dairy products, bread and pastries. With juice groove and handle. Superior quality.

PE

BEST SELLER



Ref.				
NPP2	35	25	1	0,67

HDPE 500 CUTTING BOARD - PURPLE

New Special HACCP color for non-allergenic food. Superior quality.

HDPE

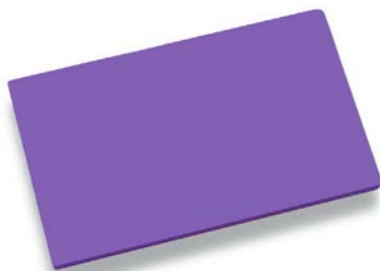

LOUIS TELLIER

Ref.				
NPP6-P	60	40	2	4,66

HDPE 500 CUTTING BOARD - BROWN

Color special HACCP for cooked meat and delicatessen. Superior quality.

HDPE



LOUIS TELLIER

Ref.				
NPP4-M	40	30	2	1,43
NPP6-M	60	40	2	4,65

HDPE 500 CUTTING BOARD WITH JUICE GROOVE - BROWN

Special HACCP color for cooked meat and delicatessen. Superior quality. With juice groove and handle.

HDPE



LT
LOUIS TELLIER

Réf.				
NPP51-M	50	30	2	3
NPP61-M	60	40	2	4,65

HDPE 500 CUTTING BOARD - RED

Special HACCP color for raw meat. Superior quality.

HDPE

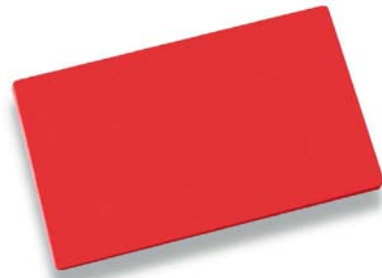

LT
LOUIS TELLIER

Réf.				
NPP4-R	40	30	2	1,5
NPP5-R	50	30	2	3
NPP6-R	60	40	2	4,65
NPP11-R	53	32,5	2	1,97

HDPE 500 CUTTING BOARD - BLUE

Special HACCP color for raw fishes and raw seafood. Superior quality.

HDPE



LT
LOUIS TELLIER

Réf.				
NPP4-B	40	30	2	2
NPP5-B	50	30	2	3
NPP6-B	60	40	2	4,65

HDPE 500 CUTTING BOARD - GREEN

GN 1/1. Special HACCP color for fruits and vegetables. Superior quality.

HDPE



LT
LOUIS TELLIER

Réf.				
NPP11-V	53	32,5	2	1,97
NPP4-V	40	30	2	2,4
NPP5-V	50	30	2	3
NPP6-V	60	40	2	4,65

HDPE 500 CUTTING BOARD - YELLOW

Special HACCP color for raw poultry. Superior quality.

HDPE

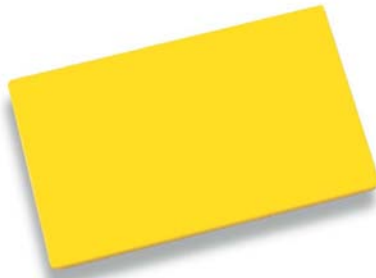

LT
LOUIS TELLIER

Réf.				
NPP4-J	40	30	2	1,5
NPP5-J	50	30	2	3
NPP6-J	60	40	2	4,65
NPP11-J	53	32,5	2	1,97

PE ECO CUTTING BOARD - WHITE

Special HACCP color for dairy products, bread and pastries.

PE «ECO» low density



LT
LOUIS TELLIER

Réf.				
NPP7	40	30	2	2,22
NPP8	50	30	2	2,8
NPP9	60	40	2	4,3
NPP14	60	40	1,5	3,4

PE ECO CUTTING BOARD - BLUE

Special HACCP color for raw fishes and raw seafood.

PE «ECO» low density



Réf.	↔	↗	⊥	♻️
NPP8-B	50	30	2	2,8
NPP9-B	60	40	2	4,3

PE ECO CUTTING BOARD - RED

Special HACCP color for raw meat.

PE «ECO» low density



Réf.	↔	↗	⊥	♻️
NPP8-R	50	30	2	2,8
NPP9-R	60	40	2	4,3

PE ECO CUTTING BOARD - GREEN

Special HACCP color for fruits and vegetables.

PE «ECO» low density

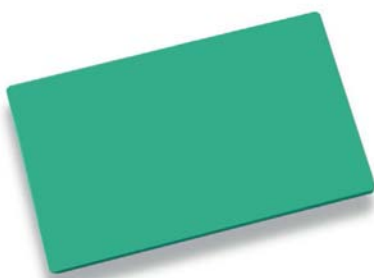

Réf.	↔	↗	⊥	♻️
NPP8-V	50	30,5	2	2,8
NPP9-V	60	40	2	4,3

PE ECO CUTTING BOARD - YELLOW

Special HACCP color for raw poultry.

PE «ECO» low density



Réf.	↔	↗	⊥	♻️
NPP9-J	60	40	2	4,3

SET OF 6 CHOPPING BOARDS

1 chopping board: 355g and 3mm thick. HACCP colors to prevent from cross-contamination : white, red, green, blue, yellow and brown.

With support

HDPE



Réf.	↔	↗	⊥	♻️
NPPC	40	30	0,3	2,13

WOODEN CUTTING BOARD WITH JUICE GROOVE

With channel and juice collector.

Beechwood - PEFC



Réf.	↔	↗	⊥	♻️
NPB07	50	30	2,5	1,31

WOODEN CUTTING BOARD WITH JUICE GROOVE LT

With juice groove. In natural wood.

Beechwood - PEFC



Ref.			
LT2131	40	26	2

PIZZA PEEL/PADDLE LT

Dual function. Ideal for restaurants or events.

Beechwood - PEFC



Ref.				
LT2101	56,5	29	1,2	non

WOODEN CUTTING BOARD FOR PARSLEY, CAKE, DRY SAUSAGE

With handle. For cutting and presenting.

Beechwood



Ref.					
NPPL28	34	14	1,5	0,33	PEFC
NPPL40	39	16	1,5	0,45	PEFC
NPPL45	44	20	1,5	0,54	PEFC

SCRAPER

2 cutting edges blade which can be sharpened. To plane knives cuts.

Tempered stainless steel blades, composite body



Ref.				
NPPR	23	6,5	4,3	0,22

PLANE

To plane knives cuts.

HDPE



Ref.				
NPPR1	17,7	6,4	8,7	0,37

SPARE BLADE

2 cutting edges blade which can be sharpened.

Tempered steel



Ref.					
NPPR01	6,4	2	0,4	0,2	NPPR / NPPR1

CUTTING BOARD RACK

For 6 boards. Wire 6 mm.

4 stands

Stainless steel



LOUIS TELLIER

Ref.				
NC016	32	26,5	30	1,15

ANTI-CUT GLOVE

Size S, M, L and XL available.

High performance polyethylene



Réf.	↔	↗	⊥	🔍
LT21P001	23,5	13,5	0,3	Size small
LT21P002	26,5	15	0,3	Size medium
LT21P003	27,5	14,5	0,3	Size large
LT21P004	28,5	16,5	0,3	Size extra-large

CHAIN MAIL GLOVE

Reversible - Wire: Ø 0.5 mm. For slaughterhouses, butchers, pork butchers, etc. Cleaning by rubbing vigorously with a brush and using 50 °C water.

Stainless steel, polyurethane

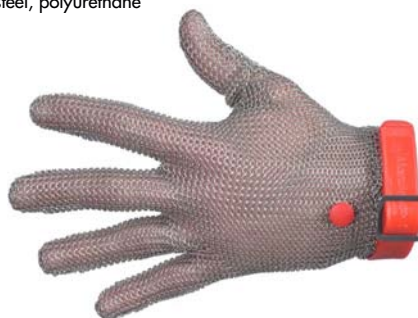

Réf.	📦	🔍
N3091	0,14	«M» - 8-85 - Red
N3092	0,14	Size L - 9-9,5 - Blue

MANUAL KNIVES SHARPENER

For fast and safe sharpening.

Tungstencarbide blade, ABS body and high density PE handle



Réf.	↔	↗	⊥	📦
AFFU-M	14,5	7	1,5	0,04

DISPLAY BOX OF 10 SHARPENERS

Cardboard



Réf.	↔	↗	⊥	📦	📦
BAFFU-M	20,5	15	8	0,54	ALFFU-M

MULTI-BLADE SCISSORS

Blade: 8 cm. Chiseled herbs 5 times faster.

5 blades

Stainless steel blade



Réf.	↔	↗	⊥	📦
CIS05B	20	7	1,5	0,13

UNIVERSAL SCISSORS

Blade: 8 cm.

Stainless steel blade



Réf.	↔	↗	⊥	📦
N3422	21,5	7,5	1	0,8

BEECHWOOD SPOON

PEFC certified.

Beechwood - PEFC



Ref.					
NM20-1	20,3	5	1,5	0,03	20 cm.
NM25-1	25	5	1	0,03	25 cm.
NM30-1	30,2	4,8	1,5	0,04	30 cm
NM35-1	34,8	5,2	1,5	0,04	35 cm
NM40-1	40,5	5	1,5	0,05	40 cm

BEECHWOOD SPATULA

Beechwood - PEFC



Ref.					
NSPO25-1	25	4,5	0,8	0,14	25 cm.
NSPO30-1	30	5	1	0,18	30 cm
NSPO35-1	35	5,2	1	0,04	35 cm
NSPO40-1	40	5,4	1	0,07	40 cm
NSPO50	50,4	7,5	1,2	0,15	50 cm
NSPO60	60	7,5	1	0,18	60 cm
NSPO80	80	9	1	0,24	80 cm
NSP100	100	10	2	0,6	100 cm.
NSP120	120	10	2	0,59	120 cm.

BEECHWOOD SLANT EDGE SPATULA

Beechwood - PEFC



Ref.					
NSPB25-1	25	5	1	0,02	25 cm
NSPB30-1	30	5	1	0,03	30 cm
NSPB35-1	35	5	1	0,04	35 cm
NSPB40-1	40	5	1	0,06	40 cm

SPOON

Dishwasher safe. Do not scratch non-stick coatings.

High temperature composite material

+ 220°C / +428°F



Ref.			
NMPA30	30	0,76	30 cm
NMPA40	40	0,98	40 cm
NMPA45	45	0,13	45 cm

SPATULA

Dishwasher safe. Do not scratch non-stick coatings.

High temperature composite material

+220°C / +428°F



Ref.					
NSPA25	25	4	1	0,3	25 cm.
NSPA30	30	4,8	1	0,52	30 cm
NSPA35	35	5,7	1	0,7	35 cm
NSPA40	40	6,5	1	0,12	40 cm
NSPA45	45	7,4	1	0,12	45 cm
NSPA50	50,3	8	1	0,16	50 cm
NSPS28	28,5			0,5	28,5 cm
NSPS29	0,05	29,5	6	0,054	29 cm.
NSPS31	31,5	7	1,5	0,5	31 cm

BOWL SCRAPER

Flexible head for scraping the edges or the bottom of a container and mixing delicate preparations such as egg whites.

Rubber, wooden handle

-50°C to +65°C / -58°F to +149°F



Ref.				
NMB25-1	25	5	1	0,21

HDPE PROFESSIONAL SPATULA WITH HOLES

Dishwasher safe. For institutional establishments.

HDPE

Up to +85°C / +185°F



Ref.					
NSPT100	100	10	2,5	0,9	100 cm.
NSPT120	120	10	2,5	1,1	120 cm.

ST/ST ROUND WIRE SKIMMER

Robust : continuous neck thread under the sieve. For recovering and draining food during cooking.

Curved hook : for hanging and pot edge

Stainless steel



Ref.	Ø	I	W	Ø
NC001	12	7,5	0,12	Ø 12 cm
NC010	16	16	0,26	Ø 16 cm
NC003	18	13	0,41	Ø 18 cm
NC057	20	20	0,43	Ø 20 cm
NC004	22	17,8	0,48	Ø 22 cm
NC005	26		0,6	Ø 26 cm

ST/ST WOVEN FRIESING SKIMMER

Resistant: continuous handle wire under the sieve.

Curved hook : for hanging and pot edge

Stainless steel



Ref.	Ø	I	W	Ø
NC1011460	14	15	0,17	Ø 14 cm
NC1011660	16	14,5	0,27	Ø 16 cm
NC1012860	28	25	0,81	Ø 28 cm

PROFESSIONAL ST/ST SKIMMER

For recovering and draining food during cooking.

Stainless steel



Ref.	Ø	I	W
LT2120	8	37	0,17
LT2121	10	41,5	0,23
LT2122	12	48	0,29
LT2123	14	54	0,38
LT2124	16	57	0,45
LT2125	18	62	0,57
LT2126	20	66	0,5

PROFESSIONAL ST/ST LADLE

Stainless steel



Ref.	Ø	I	W	Capacity
LT2102	6,5	36	0,16	70 ml
LT2103	8	40	0,23	130 ml
LT2104	9	42	0,28	200 ml
LT2105	10	44	0,36	250 ml
LT2106	11	46	0,39	300 ml
LT2107	12	49	0,45	450 ml
LT2108	14	52	0,52	670 ml
LT2109	16	58	0,68	1000 ml
LT2110	18	63	0,8	1500 ml
LT2111	20	64,5	0,9	2000 ml

PROFESSIONAL RECTANGULAR WIRE SKIMMER

Robust and practical with its long handle to safely retrieve your cooking food!
Canvas sieve : 23 x 28 cm.

Double hook: for hanging and pot edge

Stainless steel



Réf.				
NC1017260	81,2	28,4	14,7	1,1

FRY DRIPPING TRAY

Stainless steel



Réf.			
N4039X	39	16	1

CONICAL ST/ST COLANDER WITH BASE

2 handles for easy handling. On feet for optimum stability.

Stainless steel



Réf.			
LT2112	24	14	0,82
LT2113	28	15	0,96
LT2114	32	17	1,13
LT2115	36	21,5	1,4
LT2116	40	25	1,77

JAPANESE TRAYS WITH GRID

18.8 stainless steel



Réf.				
N3992	21,5	15,1	1,8	0,26
N3993	25,6	17,6	1,8	

SETTING TRAY & GRID

Get back the coating excess to reuse it. Perfect for ice, wrap, paint and drain.

Stainless steel



Réf.				
N3995	26	19	2	0,36

CHEF SERVICE TONG

Grooved ends. Anti-slip notches. Chefs tong: long, and sturdy, for tossing and serving.

Stainless steel



Réf.				
PAP4	30,5	1	1	0,09



SMALL SERVICE TONG

Specific information: Grooved ends. Anti-slip notches. Straight tong designed for handling the most delicate foods.

Stainless steel



LOUIS TELLIER

Ref.				
PAP5	15,8	1	0,6	0,02

SUSHI AND SASHIMI TONG

Grooved ends. Anti-slip notches. Angled tongs for picking up on the flat.

Stainless steel



LOUIS TELLIER

Ref.		
PAP6	15	0,02

ELECTRIC CAN OPENER FOR INSTITUTIONAL ESTABLISHMENTS

LOUIS TELLIER
RIEN NE REMPLACE LE FAIT MAIN

Tool-free removal of the «opening head» for daily cleaning in a dishwasher and sterilisation

High-output motor with **low energy use***

Opens all **cylindrical** or **rectangular** cans, even if dented to a height of between 5 and 27 cm

Clean opening: no filings inside the can. The same lever strikes and opens the can in a **single** movement.

Output: **40 to 80** cans
5x1 at a time

Accessories:
cover-retaining **magnet**

Professional electric can opener for community catering of between 300 and 800 covers:

- Made from rustproof materials. For reasons of hardness, the wheel is made from tempered steel and treated against rust.
- Two-speed motor protected by a Duralinox cover.
- High-output geared motor.
- All-metal reduction gear (metallic gearing mounted on ball bearings).
- «Motor - opening head» unit with vertical movement assisted by a gas spring enabling effortless positioning depending on the height of the can to be opened.
- Can-height adjustment stop.
- Wearing parts (blade and wheel) can be replaced by non-qualified staff.
- Tabletop device: stainless-steel base and 4 suction cups.

Patented model.

*Motor details:

230 V single-phase - 50 Hz / 60 Hz

Rating: 75 W - Couple : 13 N/m

Metallic pinion gear

ELECTRIC CAN OPENER FOR INSTITUTIONAL ESTABLISHMENTS

2 speeds (80 rpm / 125 rpm). 80 cans in one session. Single-phase. IP41. Free-standing. Assisted vertical movement. 300 to 800 covers. Opens all cylindrical and rectangular cans, including dented ones, from 5 to 27 cm height. Easy disassembly and cleaning. Complies with NF (Normes Françaises - French Standards) and HACCP.

Reversible double-life blade, 1 wheel Ø36 mm, 1 metal brush, base with 4 suction pads, magnet to hold the cover

Stainless steel

50/60 Hz - 75 W - 230 V



Réf.					
OE750	45	25	13,2	75	13,2

SPARE SET FOR ELECTRIC CAN OPENER OEXTC

1 wheel Ø36 mm, 1 blade, 1 stainless steel washer, 1 curved washer, 1 metal brush and 1 wheel wrench (not visible on the photo)

Stainless steel and cold-worked steel



Réf.		
OE896	0,14	OEXTC

PROFESSIONNAL ELECTRIC CAN OPENER - LARGE CAPACITY

IP55. To be fixed. Pneumatic-spring-assisted vertical movement. Cover held magnetically. Over 800 covers. Continuous working. Opens all cylindrical and rectangular cans, including dented ones, from 5 to 27 cm height. Easy disassembly and cleaning. Complies with NF (Normes Françaises - French Standards) and HACCP.

Control pedal, reversible double-life blade, 2 wheels: Ø36 mm for rectangular and round cans, Ø70 mm for round cans, 1 metal brush.

Stainless steel

400-500 pcs / h

50/60 Hz - 260 W



Réf.				
OE750M	32	75	32	230 V single phase
OE750M-110	32	75	30	110 V. On demand.
OE750T	32	75	32	380 V Three-phase. On demand.

SPARE SET FOR ELECTRIC CAN OPENER OE750

1 wheel Ø36 mm, 1 wheel Ø70 mm, 1 blade, 1 metal brush and 1 wheel wrench (not visible on the photo)

Stainless steel and cold-worked steel



Réf.		
OE7502	0,41	OE750M / OE750T / OE750M-110

KIT FOR ADJUSTABLE HEIGHT 12 CM

Enables the can column to be raised to 39 cm.

Stainless steel



Réf.			
OE750X	1,19	On demand	OE750

CAN TURNTABLE FOR 5 X 1 & 3 X 1 CANS

To set in front of the large-capacity can opener. Comfortable to use, no rubbing. Washable.

Ball bearing

Stainless steel



Réf.					
OE7620.	22	22	3,5	2,3	OE750M / OE750T / OE750M-110
OE7620-B					OE750

SET OF 5 REVERSIBLE BLADES FOR OEXTC & OE750

Do not sharpen the blade. Reversible: double life.

Stainless steel



LOUIS TELLIER

Réf.		
O2830-5	0,05	OEXTC / OE750M / OE750T / OE750M-110

SET OF 5 COURBANE RINGS FOR CAN OPENER

Elastic.

Elastomer



LOUIS TELLIER

Réf.	
O2873-5	0,05

COG-WHEEL FOR OE750

For OE750 (round cans).

Tempered steel



LOUIS TELLIER

Réf.			
OE7553	0,7	0,03	OE750M / OE750T / OE750M-110

SET OF 2 COG-WHEELS FOR OEXTC & OE750

For OEXTC (standard all boxes), OE750 (rectangular boxes).

Tempered steel



LOUIS TELLIER

Réf.			
OE7554-2	0,36	0,02	OEXTC / OE750M / OE750T / OE750M-110

METALLIC BRUSH

Use the metal brush to clean the wheel daily.

Stainless steel bristles



LOUIS TELLIER

Réf.	
OE821	0,03

ROLLING WORKSTATION FOR OE750

To order. For large-capacity can openers to be mounted.

4 wheels, 2 with brakes, 1 drawer, 1 lower shelf

Stainless steel



LOUIS TELLIER

Réf.					
PTX21	80 70 85	50	On demand	OE750	

HIGH-CAPACITY PROFESSIONAL ELECTRIC CAN OPENER

Opens all cylindrical and rectangular cans of a height of 5 to 27 cm, even if dented



Easy cleaning and dismantling

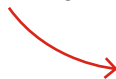

Productivity:
400-500 cans/hour



Pneumatic spring-assisted vertical movement

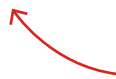

LOUIS TELLIER
BIEN NE REMPLACE LE FATI MARK



Made in France



High-capacity professional electric can opener for 800+ covers.

3 models available.

Made of stainless materials.

The wheel is made of rust-proof tempered steel to make it more durable.

NON-CUTTING EDGE CAN-OPENER



Effortless

Safely opens cans of food:
neat, blunt edges

No filings

Patented system

The device **is never in contact** with the inside of the can

Hygiene, safety,
and robustness



Opens round cans of all sizes by cutting the external seal: edges are neat, and there is no risk of cutting oneself. The can's cap can be used to protect its contents from dust and splashes (the cover no longer offers hermetically-sealed conservation).

Its weight enables it to be stable on the tin and to ensure optimum guidance.

The head design limits wearing parts as well as gaps where dirt may become lodged.

Available with a clamp plate or a screw plate.

Dishwasher-safe.

Patented system.

Made in France.

SAFETY CAN OPENER TO SCREW

Patented system. Open round cans of all sizes (ex. 5/1) by cutting out the outer setting. The edges are smooth, no risk of cutting, and it is possible to reuse the box cap to protect its contents. Be careful, once the box is open, the closure is no longer hermetic.

Stainless steel



Réf.					
OBSXP55	28	12,2	77,5	4,8	To fix on a table

SAFETY CAN OPENER - TABLE CLAMP

Patented system. Open round cans of all sizes (ex. 5/1) by cutting out the outer setting. The edges are smooth, no risk of cutting, and it is possible to reuse the box cap to protect its contents. Be careful, once the box is open, the closure is no longer hermetic.

Stainless steel



Réf.					
OBSXV55	28	12,2	77,5	4,8	With clamp fixation

ST/ST CAN OPENER - NF FOOD HYGIENE - TO SCREW

Rod 55 cm, base 22 x 12 cm. Built-in stem, one-piece head, tool-free disassembly. Dishwasher. Patented system. All types of cans.

Stainless steel



Réf.			
OXP55	78	3,2	To fix on a table

ST/ST CAN OPENER - NF FOOD HYGIENE - TABLE CLAMP

Rod 55 cm, base 22 x 12 cm. Built-in stem, one-piece head, tool-free disassembly. Dishwasher. Patented system. All types of cans.

Stainless steel



Réf.			
OXV55	78	4,2	With clamp fixation

ST/ST CAN OPENER - COMPOSITE HEAD - TO SCREW

Rod 55 cm, base 22 x 12 cm. Dishwasher. Patented system. All types of cans.

Stainless-steel stem and base, composite head



Réf.			
OX5P55	79	2,5	To fix on a table

ST/ST CAN OPENER - COMPOSITE HEAD - TABLE CLAMP

Rod 55 cm, base 22 x 12 cm. Dishwasher. Patented system. All types of cans.

Stainless-steel stem and base, composite head



Réf.			
OX5V55	79	2,8	With clamp fixation

ECONOMICAL CAN OPENER - TO SCREW

Rod 55 cm, base 22 x 12 cm. Patented system. All types of cans.

Composite head, nickel-steel stem, base of epoxy-coated steel



Ref.			
O5P55	78	2,8	To fix on a table

ECONOMICAL CAN OPENER - TABLE CLAMP

Rod 55 cm, base 22 x 12 cm. Patented system. All types of cans.

Composite head, nickel-steel stem, base of epoxy-coated steel



Ref.			
O5V55	78	2,8	With clamp fixation

LT ORIGINAL PROFESSIONNAL CAN OPENER - TO SCREW

Rod 55 cm, base 22 x 12 cm. Patented system. All types of cans.

Nickel-steel head and stem, base of epoxy-coated steel



Ref.			
O2P55	77	3	To fix on a table

LT ORIGINAL PROFESSIONNAL CAN OPENER - TABLE CLAMP

Rod 55 cm, base 22 x 12 cm. Patented system. All types of cans.

Nickel-steel head and stem, base of epoxy-coated steel



Ref.			
O2V55	77	3,35	With clamp fixation

LT PROFESSIONNAL CAN OPENER - TO SCREW

Rod 40 cm, base 18 x 8 cm. Patented system. All types of cans.

Nickel-steel head and stem, base of epoxy-coated steel



Ref.			
O3P40	62	2	To fix on a table

LT PROFESSIONNAL CAN OPENER - TABLE CLAMP

Rod 40 cm, base 18 x 8 cm. Patented system. All types of cans.

Nickel-steel head and stem, base of epoxy-coated steel



Ref.			
O3V40	62	2	With clamp fixation

SPARE SET FOR MANUAL CAN OPENER FOR O2/OX

- Blade, cog-wheel, lever and disassembly tool
- Stainless steel, tempered steel, rilsan



Réf.		
O2895	0,15	OXV55 / OXP55 / O2V55 / O2P55

SPARE SET FOR MANUAL CAN OPENER FOR O3/O5/OX5

- Blade, cog-wheel, lever and disassembly tool
- Stainless steel, tempered steel, rilsan



Réf.		
O3895	0,15	OX5V55 / OX5P55 / O5V55 / O5P55 / O3V40 / O3P40

SET OF 2 COG-WHEELS FOR OX5P55/OX5V55

Easy disassembly : block the knob using the tool, unscrew the handle by turning anti-clockwise to extract the knob.

- Dismantling tool
- Tempered steel



Réf.		
O2820-2	0,36	0,1

SET OF 5 RILSAN LEVER FOR O2/OX

- Rilsan



Réf.			
O2870-5	6	1,25	OXV55 / OXP55 / O2V55 / O2P55

SET OF 5 RILSAN LEVER FOR O3/O5/OX5

- Rilsan



Réf.			
O3870-5	4	1	OX5V55 / OX5P55 / O5V55 / O5P55 / O3V40 / O3P40

SEMI-PROFESSIONNEL CAN OPENER TITAN

Spare blades and wheels available. Adapted to large cans. The pointed blade automatically enters the can.

- Bottle opener
- Tempered steel tinned, nickel-plated steel blade, beechwood handle



Réf.				
N4041	8	6	10	0,2

CAN OPENERS - ECONOMIC PRICE

Set of 10.

Bottle opener

Tempered steel blade, stainless steel handle



Ref.				
N4056	9,5	2	2	0,35

MANUAL SAFETY CAN OPENER PALM

Clean cut and side opening, without dirtying can content. Ergonomic handle and easy to use. It ensures the safest of cuts: neat opening and no sharp edges.

ABS, steel blade



Ref.				
N4057	9,5	7,5	5	0,135

CAN PRESS

80% less waste volume! Fits to round cans 5 x 1 and 3 x 1. To crush cans.

Stainless steel



Ref.				
N8019	28,5	40,5	112	20,09

ECONOMICAL MANUAL CAN OPENER- TABLE CLAMP

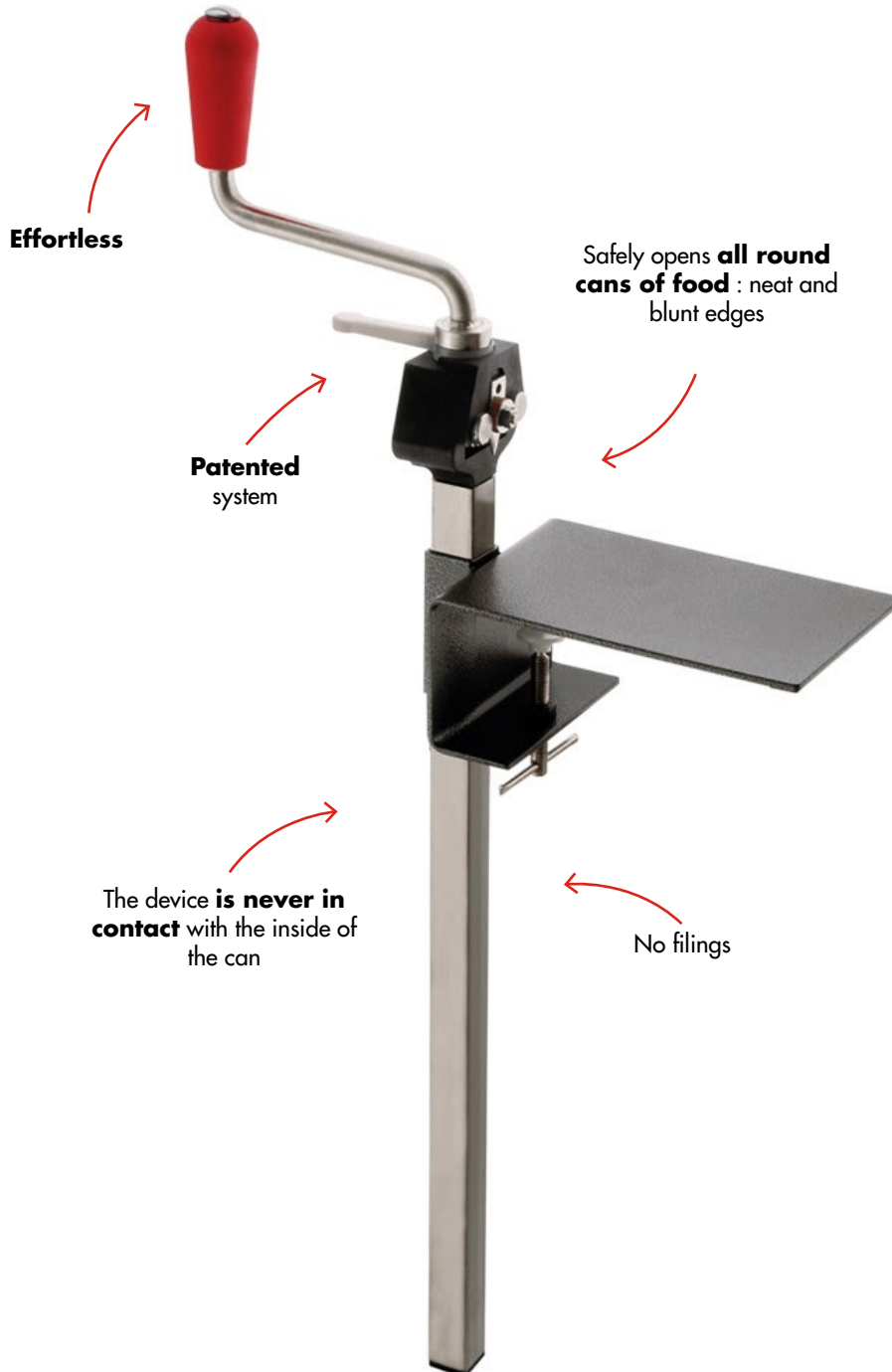

Opens all round cans of all sizes by cutting the external seal : edges are neat, and there is no risk of cutting oneself. The can's cap can then be used to protect its content from dust and splashes (the cover no longer offers hermetically-sealed conservation).

The table clamp fixing guarantees optimal stability.

Its weight enables it to be stable on the tin and to ensure optimum guidance.

The crank ensures effortless opening of boxes without filings.

Patented system.

Made in France.

COMPACT & WATERPROOF PROFESSIONAL ELECTRONICAL SCALE



LOUIS TELLIER



CULINARY PREPARATION



All stainless steel

IP67: **fully protected** against dust and temporary immersion (up to 1 m and for 30 minutes)

Compact:
reduced dimensions

Designed for all **industrial** and **food-related** applications

Units of measure:
kg, g, lb, oz

Two models available:

1. Maximum weighing 5 kg - accuracy at 0.5 g
2. Maximum weighing 10 kg (minimum 20 g) - accuracy at 1 g.

Designed for all industrial applications (especially in the agri-food industry) in difficult and humid settings (refrigerated white rooms, community catering, bakeries, etc.).

PROFESSIONAL ELECTRONIC SCALE IP53

IP53. Integrated level. Height-adjustable feet. Units of measure: kg or oz. Tare function. Programmable weight alarm. Easy recalibration. Battery-usage indicator.

Works with DC 6V 100 Ma adaptor

ABS, stainless steel removable plate



Réf.	↔	↗	⊥	⊞	⚖	⚡
N3671	31	30	11,5	3,1	Max 12 kg / Min 20 g	1 g
N3672	31	30	11,5	3,1	Max 30 kg / Min 40 g	2 g
N3673	31	30	11,5	3,1	Max 50 kg / Min 100 g	5 g

WATERPROOF PROFESSIONAL ELECTRONIC SCALE IP65

IP65. Humidity-resistant A/D Electron circuit. Units of measure: kg, lb. Tare function. Easy recalibration. Integrated leveller. Height-adjustable feet.

Mains adapter N3697-A

ABS, stainless steel, PC



Réf.	↔	↗	⊥	⊞	⚖	⚡
N3697	24	29	13	3,2	Max 15 kg / Min 20 g	2 g

COMPACT WATERPROOF PROFESSIONAL ELECTRONICAL SCALE IP67

IP67. Low battery and over-load indications. Protected against the effects of temporary immersion (up to 1 m) and for 30 minutes. Units of measurement: kg, g, lb, oz.

Stainless steel



Réf.	↔	↗	⊥	⚖	⚡
N3681	20	21,5	7	Max 5 kg	0,5 g
N3682	20	21,5	7	Max 10 kg / Min 20 g	1 g

PROFESSIONAL ELECTRONIC SCALE WITH COLUMN IP51

IP51. Integrated leveller. Height-adjustable feet. Battery life: 100 hours. Adjustable screen. Tare function. Programmable weight alarm. Easy recalibration.

Battery-usage indicator.

ABS, aluminium column, removable stainless steel tray



Réf.	↔	↗	⊥	⊞	⚖	⚡
N3684	57	32	61	9,7	Max 60 kg / Min 200 g	10 g
N3685	57	32	61	9,7	Max 150 kg / Min 400 g	20 g
N3686	67,5	42	88	13,5	Max 300 kg / Min 1kg	50 g

PROFESSIONAL ELECTRONICAL SCALE IP53

IP53. Units of measure: kg, lb, oz, single items. Functions: tare and counting items. Easy recalibration.

Battery-usage indicator

ABS, Stainless steel removable plate 22 x 16,5 cm

DC 6 V 100 mA



Réf.	↔	↗	⊥	⊞	⚖	⚡
N3693	24	24	7,5	1,9	Max 5 kg / Min 10 g	0,5 g
N3694	24	24	7,5	2,13	Max 10 kg / Min 20 g	1 g

PRECISION SCALE

Protective cover. Ideal for molecular cuisine. Touchscreen. Units of measure: g and oz.

Battery-usage indicator

ABS

Réf.	↔	↗	⊥	⊞	⚖	⚡
N3665	11,5	7,5	2,5	0,105	200 g	0,01 g



ADAPTER

Not provided with scales.

- Cable : 1,5 m
- Copper and ABS



Réf.					
N3670-A	16,5	4	7	0,642	N3670 / N3671 / N3672 / N3673
N3693-A	159	6	3,5	0,5	N3693 / N3694
N3697-A				0,1	N3697

MECHANICAL SCALE WITH ST/ST BOWL

- Removable stainless-steel bowl, Ø 20 cm
- Stainless steel, plastic dial



Réf.					
N3690	20	25	1,5	Max 3 kg	10 g
N3691	20	25	1,5	Max 5 kg	20 g

MECHANICAL SCALE WITH TRAY

- Stainless-steel tray, 25 x 25 cm
- Stainless steel, plastic dial



Réf.						
N3692	25	26	26	2,5	Max 20 kg	100 g

ELECTRONIC DOMESTIC SCALE

- Removable bowl. Units of measure: g or oz. Tare function.
- Battery-usage indicator
- ABS



Réf.						
N3695	21,5	15	4	0,28	1 kg	0,5 g
N3696	21,5	15	4	0,28	3 kg	1 g

IP51 PROFESSIONAL ELECTRONIC COLUMN SCALES



Adjustable screen



Programmable weight alarm

Tare function

Removable stainless steel plate

Height-adjustable feet

Three models are available:

1. Max weight: 60 kg (min 200 g) – accurate to 10 g (ref. N3684)
2. Max weight: 150 kg (min 400 g) – accurate to 20 g (ref. N3685)
3. Max weight: 300 kg (min 1 g) – accurate to 50 g (ref. N3686)

Ideal for all industrial applications (especially in the agri-food industry) thanks to its precise measuring abilities and high durability.

INFRARED LASER THERMOMETER



LOUIS TELLIER
NE PAS REMPLACER LE THERMOMÈTRE

CULINARY PREPARATION

Ideal for **cold room and refrigerated lorry**

Reading distance: up to **9 m**

Temperature range: from **-60°C +500°C**

Response time: **1 second**

Within an accuracy of **0.1°C**

ABS

■ Sold with cover and battery-use indicator (2 x AAA 1.5 V batteries provided).

INFRARED THERMOMETER WITH LASER SIGHT

Controls the temperature of cold rooms, refrigerated lorries, etc. Laser reading: up to 9 m away. Response time: 1 second.

Cover. Battery-usage indicator.

ABS

-60° to +500°C / -76° to 932°F

0,10°C



Ref.					
N3124	17,5	3,9	7,2	0,18	Without calibration certificate
N3124C	17,5	3,9	7,2	0,18	With calibration certificate

HACCP INFRARED THERMOMETER

Retractable probe: -55°C +330°C (-67°F +626°F). Infra-red reading: up to 1.60 m away. IP54. HACCP indicator for hot and cold connections. Min. and max. temperature scan function.

Battery-usage indicator

ABS, stainless steel

°C / °F. IR : -55°C to +250°C / -67°F to +482°F

0,2°C / 0,5 °F



Ref.				
N3127	16	3,5	2	0,1

ELECTRONIC THERMOMETER

Probe 12 cm. Foldable probe.

Strap. Battery-usage indicator.

ABS, stainless steel

-50°C to +300°C / -58°F to +572°F

0,1°C / 0,1° F



Ref.				
N3122	15,5	4,5	2	0,08

DIGITAL THERMOMETER WITH ROTATIVE PROBE

st/st, ABS, PVC

-50°C to +300°C / -58°F to +572°F



Ref.				
UTD01	16	5	1,8	0,7

MINI ELECTRONIC DIGITAL PROBE THERMOMETER

Probe: 13 cm. Memory function recording the last temperature measured.

Sheath, pen carrier

PP, stainless steel

°C / °F : -50°C to +150°C / -58°F to +302°F

0,1°C / 0,1° F



Ref.				
N3119	14,5	5,5	4	0,04

FOOD THERMOMETER WITH CASING

Cable: 1.50 m. Probe: 12.5 cm with handle and cap. Functions: memory recording the last temperature measured, min. and max.

Magnetic back

ABS, stainless steel

°C / °F : -40°C to +300°C / -40°F to +572°F

0,1°C / 0,1° F



Ref.				
N3123	18	8	2	0,09

ELECTRONIC DIGITAL PROBE THERMOMETER

Probe 12 cm. Memory function recording the last temperature measured.

- Protective case
- ABS case, stainless steel probe
- °C / °F : -50°C to +300°C / -58°F to +572°F
- 0,1°C / 0,1° F



Ref.				
N3110	22,5	2,5	1,5	0,04

WATERPROOF ELECTRONIC «PEN» THERMOMETER WITH PROBE

For perfect temperature control and mastery. Probe: 13 cm. Waterproof.

- Sheath, pen-carrier for pockets. Battery-usage indicator.
- PP sheath, stainless steel probe
- °C / °F : -50°C to +300°C / -58°F to +572°F
- 0,1°C / 0,1° F



Ref.				
N3118	21	2	2	0,03

SOUS VIDE FOAM

Roll: 5 m. For a special vacuum thermometer. To prevent from air leak during the bags perforation.

- PE foam



Ref.					
N8201	20	20	1	0,34	N8200

HYDROMETER FOR SYROP

2 trolleys: g-ml and °Bé, 1.100-1.400g-ml, 15-40°Bé. Measures the sugar density in a squash.

- Glass, paper, steel and paraffin wax



Ref.				
N3109	12	1,5	12,5	0,2

SALINITY TESTER & THERMOMETER

Salt measurement: 0% to 5%. To measure salt content in food or liquids.

- Spoon tip. Thermometer.
- ABS, PP
- 0°C to +100°C / +32°F to +212°F
- 0.001



Ref.				
N3100	23	5	5	0,06

BUTCHER THERMOMETER

For perfect temperature control and mastery.

- Sterilisable food-protection sheath
- Glass thermometer, PP housing
- 10°C to +120°C / 14°F to +248°F
- 1°C



Ref.				
N3111	33	3,5	3,5	2,13

CANDY THERMOMETER

For sugar cooking (Boulé, pearl sugar or caramel) and jams.

- Sterilisable polypropylene food sheath
- Glass thermometer
- +80°C to +200°C/+176°F to +392°F
- 1°C



Ref.					
N3113	33	3,3	3,5	0,65	PP housing
N3114	30,3	2,7	2,7	0,1	St/st housing

BAKER THERMOMETER

For perfect temperature control and mastery.

- Sterilisable polypropylene food sheath
- Glass thermometer, PP housing
- 10°C to +60°C/+14°F to +140°F
- 1°C



Ref.			
N3115	35,5	2,4	0,61

PROBE THERMOMETER

For ham, foie gras, chocolate.

- Glass thermometer
- 30°C to +100°C/-22°F to +212°F
- 1°C



Ref.		
N3117	25,5	0,16

FRIDGE-FREEZER THERMOMETER

For perfect temperature control and mastery.

- Sterilisable polypropylene food sheath
- Glass thermometer, PP housing
- 50°C to +50°C/-58°F to +122°F
- 1°C



Ref.				
N3116	33	3,5	3,5	0,05

RIDGE-FREEZER THERMOMETER - ECONOMIC PRICE

For perfect temperature control and mastery.

- Hook
- PP protective sheath
- 40°C to +25°C/-40°F to +77°F
- 1°C



Ref.					
N3120	14	1,5	1	0,01	With housing

ROUND FRIDGE-FREEZER THERMOMETER - ECONOMIC PRICE

For perfect temperature control and mastery.

- Hook
- PS, ABS, aluminium and brass
- 30°C to +50°C/-22°F to +122°F
- 1 min.



Ref.					
N3121	8	6,5	2	0,1	With dial

3 FUNCTIONS TIMER

ABS



Ref.				
UMD01	7	5,5	7	0,04

MECHANICAL TIMER 60 MINUTES

ABS



Ref.				
UMM01	6	6	3	0,07





COOKING/TEMPERATURE HOLD

COOKING

- Hot water bath and cookers
- Accessories

119

119

121



SOUSVIDE SUPREME™ WATER OVEN

SousVide
SUPREME™

Healthy, flavourful cooking that preserves all the organoleptic and nutritional properties of foods as well as their textures

No risk of over-cooking

Stress-free, unsupervised cooking thanks to the timer

Precise temperature regulation accurate to **0.5 °C**.



Even, precise, and controlled cooking, thanks to the integrated proportional **integral differential** temperature regulator

Simple functioning: prepare, season, seal, simmer, and serve!

Meat, fowl, fish, fruit, vegetables, eggs, soups, yogurt, infused alcohols, desserts, organic products, etc.: all food types can be cooked in the SousVide Supreme™ bain-marie.

It enables delicate cooking of foods sealed in vacuum-sealed hermetic bags at gentle temperatures ranging from 30 °C to 100 °C.

Cooking time varies from 20 minutes (lean fish) to 72 hours (game). The chosen temperature is maintained during the whole cooking time and thereafter: the foods can remain in the bain-marie for far longer than the required time, with no over-cooking.

The proportional integral differential temperature regulator maintains the water at a constant temperature during cooking, and uses thermal convection to ensure even temperature distribution. The foods are evenly cooked on both sides, their flavours are enhanced, and their tenderness is restored at the end of cooking.

The bain-marie functions with no:

- External pump
- Replacement of parts that may deteriorate
- Risk of pump failure
- Noise
- Risk of evaporation

SOUSVIDE SUPREME™ WATER OVEN - BLACK

For 8 to 12 parts of 115 g. Homogenous and precise temperature control. (33°F maximum gap in the water oven). Continuous monitoring of bath temperature on an LCD screen. Temperature rise in 20 minutes (from 68°F to 95°F). Sous vide cooking re-therming. Silent. Without any evaporation.

8,7 L - 2,4 gallons

Timer. Support grid for vacuum-packed bags.

St/st housing, coated steel shell, aluminium lid

50/60 Hz - 462/550 W - 220/240 V

+30°C à +100°C

0,1°C / 0,1°F



SousVide
SUPREME™

Ref.				
N8110	33	28	25	4,1

SOUSVIDE SUPREME™ POUCHES

Waffle bags with a specially-designed mesh for better air extraction during suction, and to create a watertight seal during sealing. Suitable for vacuum cooking and storage. Bain marie, microwave oven, refrigerator, freezer.

Two-layer PA/PE films, thickness : 85 microns

-20°C à +90°C



SousVide
SUPREME™

Ref.						
NVS010	30,5	20,3	0,31	0,314	25 bags of 0.95 L	NVS300
NVS020	40,6	27,9	0,55	0,539	25 bags de 3.8 L	NVS300
NVS030	61	27,9	0,73	0,729	2 rolls of 6 m (to cut and seal)	NVS300

ELECTRIC STEAMER

For 10 kg of vegetables or 8 chickens. Adjustable thermostat. Fast rise in temperature. Quick and healthy cooking. Mobile: ideal for markets and caterers.

15 L

Stainless steel

2000 W - 230 V

+70°C à +80°C



Ref.			
N8090	38	46	7

ELECTRIC EGG COOKING POT GN1/3

Can contain 10 baskets. Regulating thermostat, safety thermostat in case of over-heating or lack of water. Ideal breakfast buffet. Customers cook their egg to their individual taste.

6 numbered stainless-steel baskets. Cover.

Stainless steel

50/60 Hz - 1200 W - 220/240 V

0°C à +90°C



Ref.				
N8093	41	24	31	5

EGG BASKET

Stainless steel



Ref.				
N8093-P	5	14	16	N8093

ELECTRIC RICE COOKER

2 functions: cooking and keeping hot. When cooking is complete, «keeping hot» mode is triggered automatically. Graduated container. Safety thermostat in case of over-heating or lack of water. Large capacity and light.

21 L - 10 kg

Rice-measuring spoon

Non-stick aluminum tank

50 Hz - 3000 W - 220 V



LT
LOUIS TELLIER





Ref.			
N8094	50	52	10

COMPACT ELECTRIC RICE COOKER

Lid lock. Compact. 2 functions: cooking and keeping hot. When cooking is complete, «keeping hot» mode is triggered automatically.





-  13 L - 6 kg
-  Spatula and measure
-  Stainless steel structure and cover, non-stick aluminum tank
-  50 Hz - 1950 W - 220 V



Ref.				
N8900	45	38	34	10,4

BLACK ELECTRIC SOUP WARMER

Half-opening cover: practical service. To keep soup, mulled wine, etc., hot. Ideal for buffets. Adjustable temperature (12-setting graduated thermostat).



-  Load: 8L - Total: 10 L .
-  Nonslip feet
-  Removable stainless steel container
-  50 Hz - 400 W - 230 V
-  Max +98°C / 208°F



Ref.						
N8060	Black	34	38	4,5		

HOT SAUCE DISPENSER

Sauce portion 40 ml (adjustable). Adjustable temperature. Keeps sauces and chocolate hot. Ideal for crepes, profiteroles, etc.

-  3 L
-  Spring-closing cover
-  Stainless steel pump pipe and container



Ref.				
NDS301	18	3,87	3,87	

FRENCH FRIES SCOOP

Efficient fries service. Pick up and pour fries with the back strip. Can be inserted easily in cardboard pockets and sachet (8.5 cm large and 3.5 cm high).

Stainless steel



LOUIS TELLIER

Réf.	Length	Width	Height	Weight	Notes
N4043-ID	20	19	6,5	0,33	For right-handed
N4043-IDG	20	19	6,5	0,33	Ambidextrous

BIRD'S NEST MOULD

Ø 10 cm. Professional quality.

Stainless steel



LOUIS TELLIER

Réf.	Ø	Height	Weight
NC019	10	11	0,3

MINI RECTANGULAR FRYING BASKET

An original way to serve French fries, doughnuts, tempura... Sturdy steel double wire frame to withstand everyday use.

Stainless steel



Réf.	Length	Width	Height	Weight	Notes
NC1018160	10	8,5	6	0,15	1 portion

DEEP FRYING BASKET

Fixed handles.

Stainless steel



Réf.	Ø	Height	Weight
NC1043960	39	13	0,65

TURNER SPATULA

Blade: 15 x 10cm. Non-slip over-moulded handle x 13cm. Dishwasher safe. Thick rigid angled spatula (2mm), bevelled edges.

Tempered stainless steel, PP



LOUIS TELLIER

Réf.	Length	Width	Height	Weight
N5400	30	10	9	0,31

BEECHWOOD ROUND CREPE DOUGH SPREADER

To spread a thin and homogeneous dough. Professional quality.

Beechwood

BEST SELLER



Réf.	Length	Width	Height	Weight
NRC01-1	18	18	1	0,02

ST/ST ROUND CREPE DOUGH SPREADER

To spread a thin and homogeneous dough. Professional quality.

Stainless steel



Réf.				
NRC01X	18,5	18	1,5	0,01

CREPE DOUGH SPREADER SCRAPER

To spread a thin and homogeneous dough. Professional quality.

Beechwood



Réf.				
NRC02-1	24	18	3	0,03

BEECHWOOD CREPE SPATULA

Beechwood



Réf.				
NRC03-1	40	4,5	0,5	0,04

PROFESSIONAL OVEN MITT

Standard size: hands and wrists protection. Black color. Ambidextrous. Protection until 250°C/480°F. Watertight and boiling hot oittight.

Silicone HTS



Réf.					
N3087R	29	13	3	0,23	Short
N3087RL	43	16	3	0,36	Long

AMBIDEXTROUS HEAT RESISTANT GLOVE

Work glove, PPE, professional quality.

Aramid fibers

LOUIS TELLIER

Réf.					
GAN13	31	14	27,5	0,09	Unique size. Red and black.

ELECTRIC RICE COOKER



LOUIS TELLIER
SEEN NE REMPLACE LE FAYE MARIN

2 functions:
cook and keep warm

Inner pot **with**
graduated markings



Safety thermostat
in case of overheating or lack of water

Large capacity:
up to **10 kg** of rice

Large capacity electric rice cooker.

Automatically switches to 'keep warm' mode once the rice is cooked.



COFFEE/BAR/RECEPTION

JUICE	127
BAR ACCESSORIES	129
BREAKFAST/RECEPTION	133

LEVER-OPERATED POMEGRANATE AND CITRUS JUICER



Effortless maximum pressure thanks to the spring-mounted double-turn side lever

Aluminium, chrome steel, and stainless steel

Push-piece and grid **tailored** to pomegranates, oranges, and grapefruit

Non-slip handle

Removable stainless-steel **rotary drop collector**

Stable, thanks to its **non-slip** chrome-steel base



Tabletop model with its elegant design.

Pomegranate is known for its antioxidant benefits - detox juices are all yours!

The removable grid, the push-piece, and the drop collector are made of stainless steel.

ELECTRIC JUICE EXTRACTOR

To extract juices from vegetables / fruits (smoothie, cocktails ...). Air-cooled motor, qualified for continuous operation. Automatic ejection of marc and pulp in a quick handling recuperator tank. Very stable with its 4 suction cups mounted on silent-blocks.





 Speed: 6300 rpm regulated automatically. 1 turbo position.

 Stainless steel

 Ex. : Carots = 60 kg / hours

 450 W



Ref.				
CEN426	3,1	1,9	3,8	3,96





LEVER-OPERATED POMEGRANATE AND CITRUS JUICER

Plunger and mesh adapted to pomegranates, oranges, and grapefruit. Double-locking side lever for maximum pressure. Non-slip handle.

 Anti-drip container

 Aluminium, chrome steel, stainless steel



Ref.				
N4097	27	19,5	50	6





LEVER-OPERATED COUNTERTOP CITRUS JUICER

Height with the handle in the upright position: 83.5 cm. Highly professional. Powerful front lever. Comfortable non-slip handle.

 Cutting board with pads

 Aluminium, chrome steel, ABS cone







Ref.				
N4098	40	25	50,5	6,9

MANUAL LEMON SQUEEZER

With bowl and pouring spout. For lemons, limes, and oranges.

 Stainless steel



Ref.				
N4105	17	13	12	0,29

LEMON SQUEEZER 1/2 SLICE

Squeezes lemons cleanly with a press of the thumb. Neat and clean service. 1 for 2 people. For 1/2 slices of lemon 1 cm thick.

 Copolyester



Ref.					
N4120	12	3	6	0,05	Each unit in a polybag

LEMON SQUEEZER 1/2 SLICE - DISPLAY

Squeezes lemons cleanly with a press of the thumb. Neat and clean service. 1 for 2 people. For 1/2 slices of lemon 1 cm thick.

 Copolyester



Ref.					
N4120-24P	12	2,5	5	1,6	A display of 24 (12 boxes of 2)

ST/ST LEMON REAMER

Stainless steel



Réf.				
N4107	16	4	4	0,09

MEASURING POURERS

For dry alcohol. The colours make it easy to know the measure, even in a dark environment.

- 2 cl
- Plastic



Réf.	Length	Width	Weight	Color
DP212-J	9,5	4	0,02	Yellow - 2 cl
DP213-V	9,5	4	0,02	Green - 3 cl
DP214-B	9,5	4	0,02	Blue - 4 cl
DP215	9,5	4	0,02	Red - 5 cl

POURER

Seasoning and garnishing when plating up.

- Metal



Réf.	Length	Width	Weight
DO956	11	3	0,15

ST/ST DOUBLE JIGGER

Measures of 1, 2, 3, and 4 cl. Graduated in cl.

- 2-4 cl
- Stainless steel



Réf.	Length	Width	Height	Weight
N4135	4,5	4,5	7	0,04

SOMMELIER CORKSCREW

Screen printing possible.

- Stainless steel mechanism, metal handle with plastic insert, Teflon coated metal bit.



Réf.	Length	Width	Height	Weight	Color
TBCOU02-R	12	20	1,4	0,07	Burgundy red
TBCOU01-N	12	20	1,4	0,07	Black

WINE WAITER 2 BOTTLE OPENERS

Multifunction corkscrew, bottle opener, and foil cutter.

- Chrome steel



Réf.	Length	Width	Height	Weight	Quantity
N4312	14	3,5	1	0,07	2 decappers

WINE WAITER 1 BOTTLE OPENER

Multifunction corkscrew, bottle opener, and foil cutter.

- Chrome steel



Réf.	Length	Width	Height	Weight	Quantity
N4313	11	2,5	1	0,05	1 decapper

WAITER'S FRIEND

Double lever with 2 support points. Reduced effort. 2-step cork removal using a simple pressing motion.

Teflon-coated stem, toothed foil cutter

Stainless steel, ABS



Réf.				
N4319	12,7	3	1,6	0,03

BOTTLE OPENER WITH COLLECTOR

Integrated collection box. Wall fixation.

Stainless steel



Réf.				
N4055X	10	6	30,5	0,38

COCKTAIL MASTER

Create cocktails of several colors layers: Irish coffee will be a success! Ø min. - max. of the glass: 5 - 10.5 cm.

Chromed



Réf.					
DO251	12	12	27	0,5	Chromed

SET OF 2 WHISK KEY-RING

Nickel-plated steel



Réf.				
N3082	13	6	1,5	0,18

CHAMPAGNE CAP

Fully watertight. Effective blocking. Keeps champagne sparkling.

Chrome steel, TPR



Réf.				
N4054	3	5,5	0,07	N4054

SODA SELTZER

St. S tank. To produce 1 litre of sparkling water.

1 L

Stainless steel tank



Réf.							
N4075X	18,5	9	32,5	0,85	Siphon		
N4074				0,3	CO2 chargers		N4075X

FUNNEL WITH FILTER

Removable filter. To decant wine. Filters deposits. Capacity : 400 ml.

Stainless steel



Réf.				
N3740	15	13	13	0,16

STIRRER

A spoon at one end, a fork at the other.

Stainless steel



Réf.				
N4134	31,5	2,5	0,4	0,03

MASHER FOR COCKTAIL

Beechwood



Réf.				
N4136	20	3,5	0,06	Wooden

MASHER FOR BRASILIAN COCKTAIL

Beechwood



Réf.					
N4140	21,5	3,2	3	0,08	Brazilian

WINE GLASS CLIP SUPPORT

For wine glass <1,2 cm. Set of 20. For cocktail receptions and buffets stand up. Holds the glass on the edge of the plate.

PP



Réf.				
N4142-20	14	10	5	0,16

TEA TONG INFUSER

Individual infusion directly in a teacup.

Tongs

Stainless steel



Réf.			
N9200	4	4,5	0,04

TEA, HERB AND SPICES INFUSER

To add flavour without herbs and spices spreading through the dish.

Stainless steel



Ref.				
N9201	4,5	3,5	0,03	4.5 cm
N9202	6,5	5	0,04	6.5 cm

CALL BELL

Stainless steel, ABS

BEST SELLER



Ref.			
N8040	8,5	7	0,11

THE LUTIL SLICER

It stands out for its worked design and retro style. Made in small series, it is a unique piece of art, engraved with its edition number by the hand of his creator and entirely assembled by hand. Certificate of authenticity, ergonomic handle, blade adjuster lock, three non-slip pads, linen sausage pocket.

Removable massive blade

Painted die-cast aluminum body and solid stainless steel resharpenable blade



Ref.				
TAS	25	9,5	8,5	1,2

GLASS RACK

5 rows. About 20 glasses. Double fixing: wall-mounted and / or under-shelf.

4 screws and dowels

Chrome steel

BEST SELLER



LOUIS TELLIER

Ref.				
NC018D	45	32	6	1,7

COFFEE MAKER

Safety thermostat with automatic reset. Locking cover. Graduated fill-level gauge. 2 separate resistances (heating and maintaining temperature). Double-walled and insulating handles. «Keep hot» function.

Cups: N5308 = 50 / N5312 = 75 / N5316 = 100. Nominal volume : N5308 = 6.3L / N5312 = 9.6L / N5316 = 13.2L.

Anti-drip tap. Permanent stainless-steel filter for standard version. Cover-blocking system.

Brushed stainless steel

N5308 : 14 cl/ min - N5312 : 24 cl/min - N5316 : 24 cl/min

50 Hz - 950 W - 230 V



Réf.				
N5308	22	42	3	6.3 L
N5312	27	43	3,82	10 L
N5316	27	51	4,35	13,2 L

WATER BOILER AND TAP

With tap to be able to serve. Adjustable temperature.

Max. 20 L - Min. 5 L

Safety tap

Stainless steel

100°C : 40 min / 10L or 1 h / 20L

70°C : 25 min / 10L or 37 min / 20L

50°C : 13 min / 10L or 30 min / 20L.

2100 W - 230 V

+30°C à +100°C



Réf.			
N8091	37	46	5,7

HOT CHOCOLATE DISPENSER

Removeable reservoir for refrigeration and cleaning. Fully-removable tap for steam-cleaning. Adjustable thermostat. Chocolate making = 30 min. Reheating = 15 min.

5 L

Anti-drip tap and reservoir.

ABS, tritan

50 Hz - 1100 W - 230 V

+30°C à +90°C



Réf.			
N4905	48,5	52	6

SCREW VACUUM INSULATED JUGS

Vacuum insulated stainless-steel double-wall. Unbreakable. Stay cool handle. Hot drinks: 6h : > 160°F (room t° 70°F). Cold drinks: 12h : < 60°F (room t° 95°F).

Stainless steel, ABS



Réf.				
N5069	13	22	0,6	1L.

SCREW TOP

Ergonomic. Waterproof.

ABS



Réf.					
N5069-B	10	8	4,5	0,02	N5069

VACUUM INSULATED JUGS TRIGGER TOP

Vacuum insulated stainless-steel double-wall. Unbreakable. Stay cool handle. Hot drinks: 6h : > 160°F (room t° 70°F). Cold drinks: 12h : < 60°F (room t° 95°F).

Stainless steel, ABS



Réf.				
N5070	14	19	0,75	1,2 L
N5071	14	22	0,9	1,5 L
N5072		14	26	2L.

TRIGGER TOP

NF certified. Easy serving. Waterproof.

ABS



Réf.					
N5072-B	10	9	4,5	0,06	N5070 / N5071 / N5072

WHITE THERMO JUG

Vacuum-insulated and double-walled. ABS exterior. PP interior. Unbreakable. Porcelain appearance. Ideal for catering, hospitals, care homes for the dependent elderly, etc.

Trigger-activated watertight stopper

ABS, polypropylene



Réf.					
N5076	18	9	20	0,5	0,6 L
N5077	22	13,5	25	0,8	1,2 L

BLACK THERMO JUG

Vacuum-insulated and double-walled. ABS exterior. PP interior. Unbreakable. Porcelain appearance. Ideal for catering, hospitals, care homes for the dependent elderly, etc.

Trigger-activated watertight stopper

ABS, polypropylene



Réf.					
N5078	17,5	12	21	0,5	0,6 L

VACUUM INSULATED POTS

Vacuum-insulated, double-walled, stainless-steel bulb. Pump pourer. Easy service by pressure. Unbreakable.

Hot drinks: 6h : > 160°F (room t° 70°F). Cold drinks: 12h : < 60°F (room t° 95°F).

Carry handle

Stainless steel, ABS



Réf.						
N5084	21,5	15	32	1,3	1,9 L	
N5085		21	14,5	36	1,5	2,5L.
N5088	18	24	33	2	3L	
N5089	26	17	38,5	2,2	4L	

TWISTED THERMO JUG



LOUIS TELLIER
BIEN NE REPPLACE LE FAIT MAIR

Hinged lid
 with thumb lever mechanism
 for pouring

Polyurethane foam
 insulation

Comes with **three**
colour-coded
plastic clips to reduce
 drink mix-ups

Shock-resistant
 polycarbonate coating

Triple wall insulation to keep drinks at the ideal temperature.
 Highly durable and resistant to impact, peeling and cracks.
 2 sizes: 1.2 L and 0.9 L
 2 colours: white or black.



TABLE SERVICE AND BUFFET

TABLE ACCESSORIES	139
BUFFET ACCESSORIES	141
SERVING ACCESSORIES	143
ORDERS ACCESSORIES	144

PEPPER MILL

PERFEX

PERFEX[®]



Grinding adjustment
button

Carbon-steel mechanism,
cast-aluminium body

Patented filling channel

Made in limited numbers in France
since 1946

Can hold **40 g**

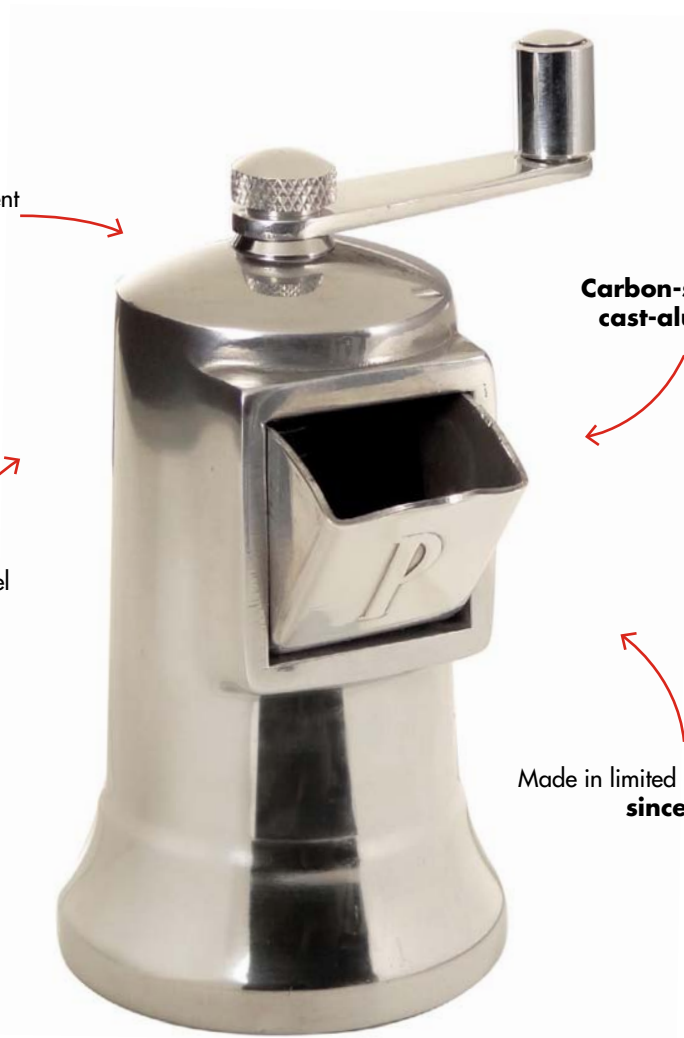

The very best of vintage beautiful objects made in France!

Prized by collectors, present on great foreign tables for seven decades, and passed down from generation to generation in leading USA and English families, Perfex mills are made in France and are available on the French market.

Perfex mills, manufactured in limited number in France since 1946 in a high-precision mechanical workshop, are jewels of technicality.

Made of robust moulded aluminium and fitted with a special steel mechanism, cut and treated to ensure optimum grinding, this mill with an «industrial» design and «vintage» packaging is timeless.



Please note: no exchange or return.

SMALL SALT GRINDER

One finger pressure! In the kitchen or on the table. Sold empty.

 Stainless steel



Ref.			
N4150	2,7	13,5	0,18

SMALL PEPPER GRINDER

One finger pressure! In the kitchen or on the table. Sold empty.

 Stainless steel



Ref.			
N4151	2,7	2,5	0,18

PERFEX® PEPPER MILL - 40G



High quality construction. Patented fold out fill spout. Choose grind by adjusting the knob.

 40 g

 Carbon steel grinder, cast aluminum body



PERFEX

Ref.			
N4153	7	66	11
			0,3

PERFEX® PEPPER MILL - 110G



High quality construction. Patented fold out fill spout. Choose grind by adjusting the knob.

 110 g

 Carbon steel grinder, cast aluminum body



PERFEX

Ref.			
N4154	9	9	19
			0,84

PERFEX® SALT MILL



High quality construction. Patented fold out fill spout. Choose grind by adjusting the knob.

 40 g

 Stainless steel grinder carved, cast aluminum body



PERFEX

Ref.			
N4155	7	5,8	11,1
			0,3

EGG CUP

 Chrome steel



Ref.			
NC036	4,5	6	0,05

SEAFOOD TRAY STAND

Ø top : 19 cm.

BEST SELLER

LOUIS TELLIER

Réf.	Ø	H	P	Mat.
NC020	20	19,5	0,26	St/st
NC020-C	20	19,5	0,27	Chrome steel

WINE BUCKET HOLDER

wire 8 mm: superior strength. Fixes to the edge of the table.

Bucket not included

Chrome steel



LOUIS TELLIER

Réf.	L	H	P	P
NC024	49	21	17,5	0,5

RECTANGULAR NAPKIN HOLDER

Stainless steel

NEW

LOUIS TELLIER

Réf.	L	H	P	P
LT20P004	13	8,5	3	0,1

STAINLESS STEEL BREAD / FRUIT BASKET 24 CM

Stainless steel



LOUIS TELLIER

Réf.	Ø	H	P
LT20P003	24	8	0,21

STAINLESS STEEL BREAD / FRUIT BASKET 20 CM

Stainless steel



LOUIS TELLIER

Réf.	Ø	H	P
LT20P002	20	8	0,18

FRUIT BASKET

Stainless steel

BEST SELLER



Ref.			
N4110	23	25	0,66

SNACKING BASKET

Ideal for self-service: sandwiches, canned drinks, salads, and dishes in tubs.

Tray

PP tray, chrome basket



Ref.				
NC7020160	30	24	12,5	0,6

TOAST RACK

For 6 slices. Interval between each arch : 20 mm.

Chrome steel



Ref.				
NC061	15	8	9	0,14

PLATE-WARMER WITH CANDLES

Supplied with non-smoking candles.

Burnished steel candle cup

Chrome steel wire



LOUIS TELLIER

Ref.					
803CHP1	20	19,5	6,5	0,47	1 candle
803CHP2	34	20	6,5	0,7	2 candles
803CHP3	47	20	6,5	0,98	3 candles

DISH WARMER

Wire Ø5mm.

Two dish-heating lights

Chrome steel



LOUIS TELLIER

Ref.				
NC3016050	30	19	8	0,92

SAUCE DISPENSER FOR MASS CATERING

Sauce portion 40 ml (adjustable). Sauce-portion dispensing pumps designed for intensive use, adapted to mass catering and fast-food outlets. Lever mechanism made entirely of St.S.

Spring-closing cover

Stainless steel pump pipe and container



LOUIS TELLIER

Ref.			
NDS500	18	42	5L

SALAD TONGS

Stainless steel

LOUIS TELLIER

Ref.				
N3066	24	9	4,5	0,12

MULTI-PURPOSE TONGS

Ideal for buffets, company catering, etc. Superior quality.

Stainless steel

BEST SELLER
LOUIS TELLIER

Ref.					
N3067	24	3,5	4	0,1	24 cm.
N3068	30	4	3,5	0,15	30 cm
N3069	40	4	4	0,2	40 cm
N3072	23	4	3	0,05	23 cm.
N3073	30	3,8	3	0,07	30 cm
N3074	40	3,5	3	0,09	40 cm

PVC AND ST/ST TONGS

Stainless steel and PVC

NEW

LOUIS TELLIER

Ref.				
LT2117	24	10	4	0,136
LT2118	30	14,5	4	0,178
LT2119	40	5	4	0,198

STAINLESS STEEL TONGS

Stainless steel

NEW

LOUIS TELLIER

Ref.				
LT2127	18	6,5	3	0,047
LT2128	24	7,2	3,5	0,089
LT2129	30	11,5	4	0,098
LT2130	40	13,5	3,5	0,147

POCKET CRUMBER



Pocket model. Handle in the shape of elm burl.

 Penholder

 Stainless steel, plastic



LOUIS TELLIER

Réf.					
RAM	14	3	1	0,04	Blister

ROUND ADDITION TRAY

 Stainless steel

 NEW



LOUIS TELLIER

Réf.			
LT19P002	14	1,5	0,06

RECTANGULAR ADDITION TRAY

 Stainless steel

 NEW



LOUIS TELLIER

Réf.				
LT19P001	17	11,5	1	0,1

CHECK HOLDER WITH MARBLES

For good communication between dining room and kitchen.

Screws and dowels

Stainless steel and marbles

BEST SELLER



LOUIS TELLIER

Ref.						
N8028	25	7,5	2	0,27	25 cm.	
N8029		50	7,5	2	0,42	50 cm

CHECK HOLDER WITH SPRINGS

8 springs. To place orders in their proper sequence.

Screws and dowels

Stainless steel

BEST SELLER



LOUIS TELLIER

Ref.						
N8030		64	10	2	0,8	8 springs
N8031	100	10	1,5	1	13 springs	

NOTEPAD HOLDER

Wall fixation.

Note paper and pencil holder, 2 screws and plugs

Stainless steel



Ref.				
N8033	24	10	6,5	0,33

8-SPRING TAB GRABBER



LOUIS TELLIER
REN NE REMPLACE LE FANTÔME

BEST
 SELLER

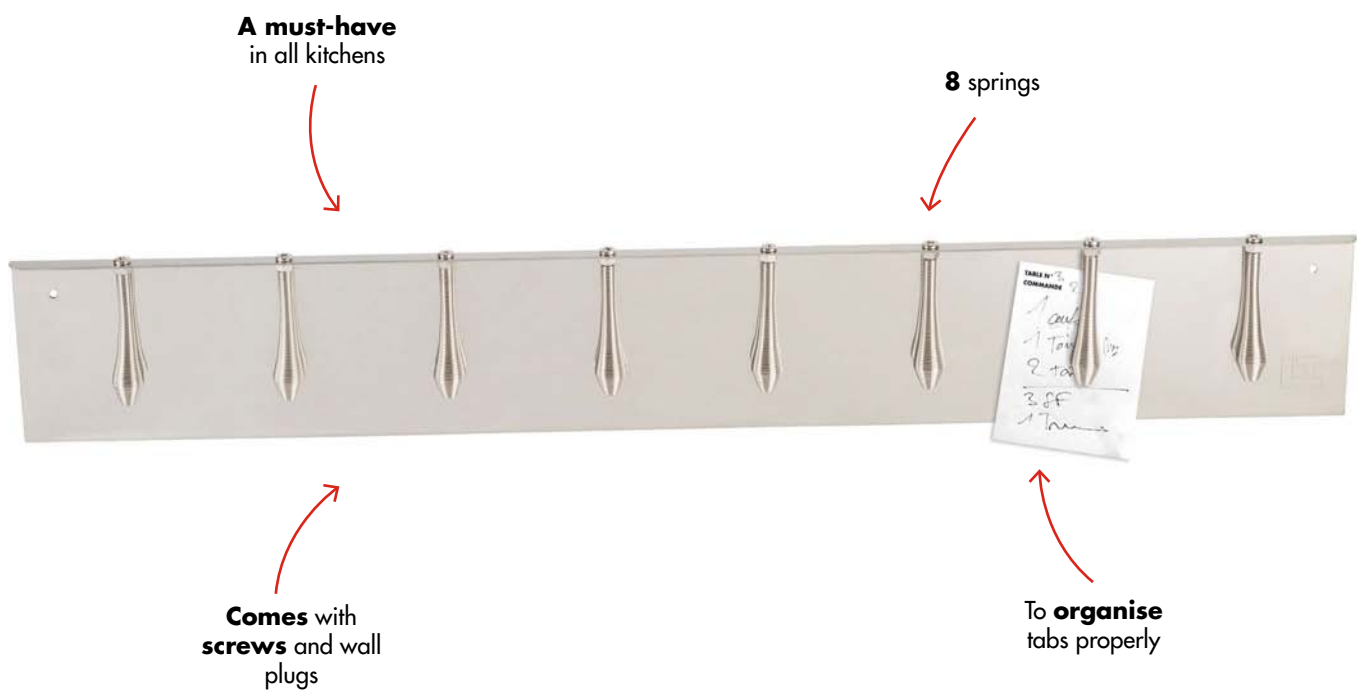

A must-have in all kitchens!

The shape of the springs has been specially designed so you can add and remove all kinds of paper without having to touch the tab grabber.

Made of stainless steel for maximum hygiene. Also available in 1 m with 13 springs.



PRESERVATION

VACUUM SEALING MACHINES	149
RULERS & DISPENSERS	150
DEHYDRATORS	151
CONDIMENT DISPENSERS	153

CLING FILM AND ALUMINIUM DISPENSER



LOUIS TELLIER
RIEN NE REMPLACE LE FAIT MAIN

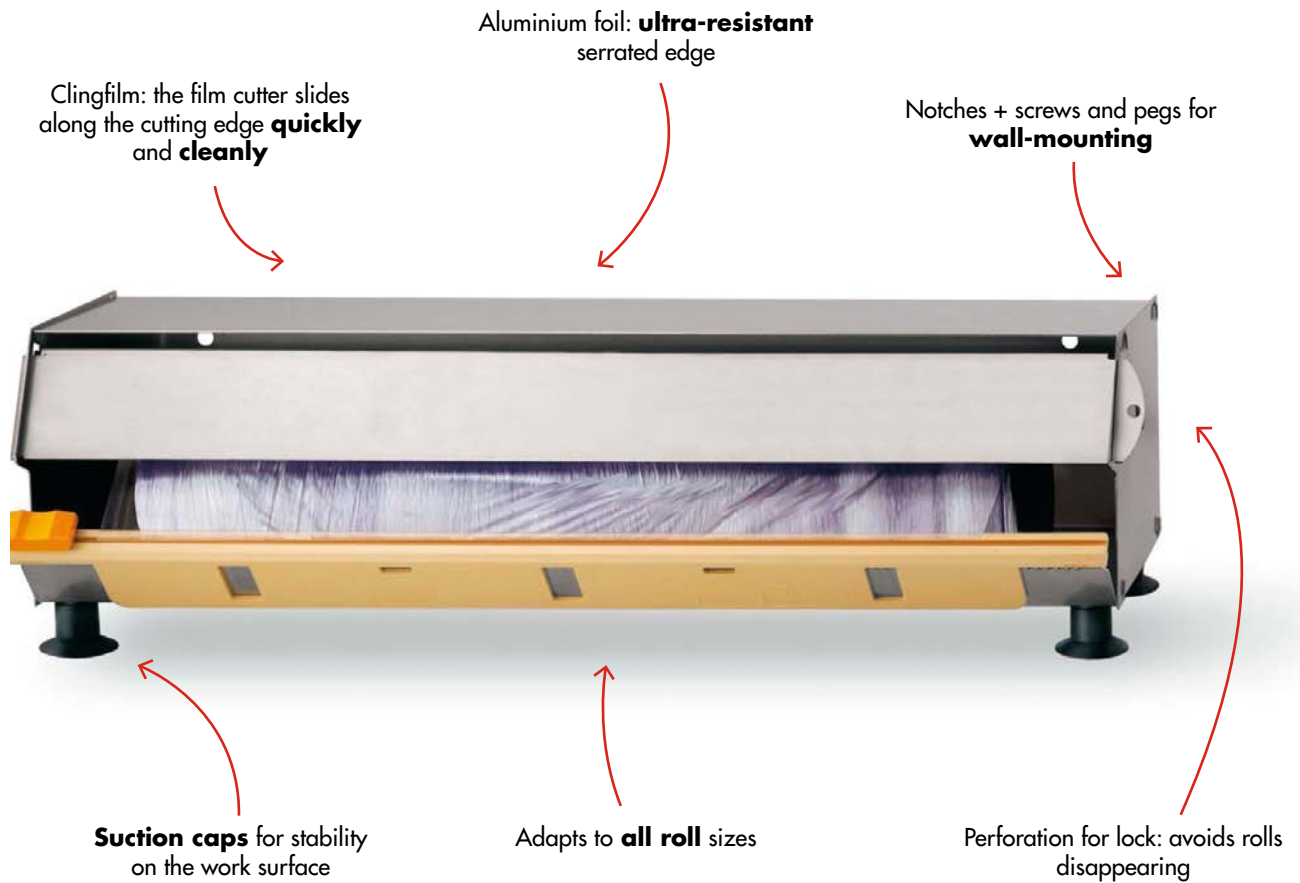

Clingfilm: the film cutter slides along the cutting edge **quickly** and **cleanly**

Aluminium foil: **ultra-resistant** serrated edge

Notches + screws and pegs for **wall-mounting**

Suction caps for stability on the work surface

Adapts to **all roll** sizes

Perforation for lock: avoids rolls disappearing

This product allows rolls to be stored following good hygiene rules for protecting food.

SEMI-PROFESSIONAL VACUUM SEALING MACHINE

Self-lubricating 2-piston pump. Liquid channel and collector; machine stops automatically to avoid damage to pump. Automatic locking whilst vacuum-packing. Automatic stop at -0.5 bar. Waiting time between vacuum-packing sessions: 20 sec. Bag-sealing function. Heating strip: L 30 cm. For vacuum cooking and storage.

22,5 L /min

Suction hose and adapter for dishes, covers, carafe, and stopper from the range. Compartment for rolls and bag cutter. 2 rolls (1.5 m x 20 cm + 1.5 m x 28 cm) + 3 bags measuring 28 x 36 cm + 3 bags measuring 20 x 28 cm.

ABS

- 0,8 bar. 2900 tpm.

50 Hz - 240 W - 230 V



Ref.				
NV400	38	25	10	3,6

VACUUM BAGS

Specially-designed mesh for better air extraction during suction, and to create a watertight seal during sealing. Suitable for vacuum cooking and storage. Bain-marie, microwave oven, refrigerator, freezer.

Two-layer PA/PE film PA 1 micron, 13 microns PE

-20°C à +100°C



Ref.				
NV010	36	28	0,56	Set of 25 bags 36 x 28 cm
NV011	28	20	0,52	Set of 40 bags 28 x 20 cm
NV012	55	13	0,51	Set of 30 bags 55 x 13 cm

VACUUM SEALER BAG ROLLS

For cutting and sealing to your dimensions. Specially-designed mesh for better air extraction during suction, and to create a watertight seal during sealing. Suitable for vacuum cooking and storage. Bain-marie, microwave oven, refrigerator, freezer.

Two-layer PA / PE film, smooth part : 130 microns thickness, waffled part : 13 microns

-20°C à +100°C



Ref.			
NV013	28	0,56	Set of 3 rolls
NV014	20,5	0,59	Set of 4 rolls
NV015	13	0,46	Set of 5 rolls

BAG DISPENSER

Wall or table fixation.

Stainless steel



LOUIS TELLIER

Ref.				
B1095	14,5	9,5	31,5	1,1

PAPER ROLL CUTTER

Width roller: 35 cm Ø 20,5 cm. Counter's model.

Stainless steel



LOUIS TELLIER

Ref.				
DP000	45	29	33	0,9

CLING FILM AND ALUMINIUM DISPENSER

Thin roll-holding stem that adapts to all tube diameters. Internal dimensions > 10 cm than film width to adapt to all roll widths. NF food hygiene: roll storage following proper hygiene rules to protect foodstuffs. Serrated edge for aluminium foil, film cutter for clingfilm. To be used free-standing or fixed to the wall.

Cutting blade for clingfilm 4 suction pads, 2 screws + dowels

Stainless steel



LOUIS TELLIER

Ref.						
DFV300	40	14	16	2	30 cm	
DFV450		56	14	16	2,8	45 cm

CUTTING BLADE FOR CLING FILM

For sliding along the edges of stainless-steel rollers or cardboard boxes. Sliding the cursor cuts the film cleanly.

PP



Ref.						
DF030		40	4,5	1,5	0,06	30 cm
DF045		55	5	2	0,1	45 cm

DEHYDRATOR FOR FRUITS AND VEGETABLES

Unprogrammable. To conserve, decorate and innovate: light vegetables chips, dried vegetables strips sugar concentrate...

5 stackable trays

ABS, Tritan

50 Hz - 250 W - 220/240 V

Max. 80°C



Ref.			
N3040	33	20	3,2

PROGRAMMABLE DEHYDRATOR

Up to 20 trays. Timer and temperature control. To conserve, decorate and innovate: light vegetables chips, dried vegetables strips sugar concentrate...

6 stackable trays

ABS

50 Hz - 530 W - 220/240 V

30°C - 80°C (86-248°F)



Ref.				
N3042	43,5	29	21	3,6

ACCESSORIES FOR NON PROGRAMMABLE DEHYDRATOR

PP + Tritan



Ref.							
N3040-F	29,5	29,5	0,1			0,04	Food grade sheet
N3040-P				33	3	0,1	Tray

ACCESSORIES FOR PROGRAMMABLE DEHYDRATOR

PP + ABS



Ref.					
N3042-F	44	29	0,1	0,06	Set of 2 food grade sheets
N3042-P	43	29	3	0,26	Tray

JAPANESE BOXES



Durable, no deterioration of the material

18.8 stainless steel

Hygienic: **easy** to wash

Protection against light

Long-lasting freshness thanks to stainless-steel **conductivity**

Perfect for keeping your mises en place as they should be: cleanliness and freshness maintained in the fridge from morning until service on the work surface.

ST/ST CONDIMENT DISPENSER - 4 PP BUCKETS

Removable containers: 14 x 7,7 x 7 cm. Your ingredients, garnishes, and spices within reach. For sandwiches, pizzas, sushi, maki, plating up, cocktails, etc.

1 recipient = 47 cl / 500 g.

Stainless steel



Ref.						
N4401	30	14,5	10	0,24		4 buckets

ST/ST CONDIMENT DISPENSER - 6 PP BUCKETS

Removable containers: 14 x 7,7 x 7 cm. Your ingredients, garnishes, and spices within reach. For sandwiches, pizzas, sushi, maki, plating up, cocktails, etc.

1 recipient = 47 cl / 500 g

Stainless steel



Ref.						
N4403	45	14,5	9,5	1,15		6 buckets

PP BUCKET FOR N4401/N4402/N4403

Removable containers: 14 x 7,7 x 7 cm. Your ingredients, garnishes, and spices within reach. For sandwiches, pizzas, sushi, maki, plating up, cocktails, etc.

1 recipient = 47 cl / 500 g

PP



Ref.						
N4404	14	7,7	7	0,04		Spare bucket N4401 / N4402 / N4403

PP BUCKET FOR N4408

Removable containers 14 x 11 x 7 cm. Your ingredients, garnishes, and spices within reach. For sandwiches, pizzas, sushi, maki, plating up, cocktails, etc.

1 recipient = 78 cl / 850 g.

ABS, PP



Ref.					
N4409	14	11	7		Spare bucket N4408

ABS CONDIMENT DISPENSER - 4 PP COMPARTMENTS

Removable containers 14 x 11 x 7 cm. Your ingredients, garnishes, and spices within reach. For sandwiches, pizzas, sushi, maki, plating up, cocktails, etc.

1 recipient = 78 cl / 850 g.

ABS, PP



Ref.						
N4408	49	15	9,5	1,2		4 buckets

JAPANESE MINI-BOXES

18.8 stainless steel



LOUIS TELLIER

Ref.					
N4410	28	11,5	6		4 x boxes N4390T
N4411	22,4	14,9	6,3	1,64	5 x boxes N4391T
N4412	32,8	14,8	6,3		6 x boxes N4390T
N4413	43,2	14,8	6,3		8 x boxes N4390T

JAPANESE BOX

18.8 stainless steel

LOUIS TELLIER

Ref.					
N4390C	11,6	7,7	0,8	Lid	N4390T
N4390T	10,5	6,8	5,8	Container	N4390C
N4391C	14,7	11,6	1	Lid	N4391T
N4391G	11,6	8,4	1,1	Sieve	N4391T
N4391T	13,7	10,6	6	Container	
N4392C	17,4	12,3	1	Lid	N4392T
N4392G	14,3	9,2	1,1	Sieve	N4392T
N4392T	16,2	11,1	6,7	Container	





HYGIENE

DISPENSERS

159

ST/ST HYGIENIC STATION HANDS-FREE PEDAL (HYDROALCOHOLIC GEL DISPENSER)

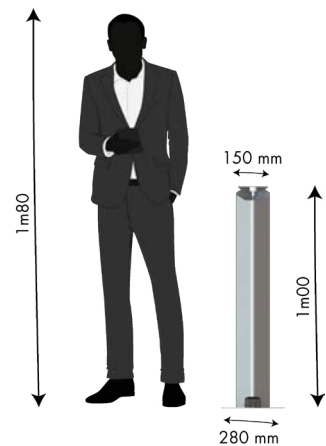

Cover to be opened for changing the pump bottle and adjusting the height of the mechanism

Fill level indicator of the pump bottle

Anti-theft :
- Reduced opening (6cm)
- Screwed (allen key supplied)

Adapted **to all** pump bottles
> up to **11 cm** in diameter
and from **7 to 30 cm** in the height

100% **stainless steel**

- **Stability:** heavy base (280mm wide)
- **2 holes** (Ø11) for floor fixing

Mecanical pedal action

Universal foot-operated hydroalcoholic gel dispenser. Contactless for foolproof hygiene!

- 2D bent sheet metal assembly
- Matte finish, delivered with PVC protection
- Hydroalcoholic gel not provided

2 years warranty

ST/ST PEDAL-OPERATED HYGIENIC STATION

Universal foot pedal sanitizing gel dispenser, Hands-free for maximum hygiene! All stainless steel, solid and durable. 100% mechanical, pedal-operated. Adapted for all sizes of bottles with sanitizing gel pump up to 11 cm in diameter and from 7 to 30 cm high.

Cover Screwed - allen key supplied

Stainless steel



Réf.				
SHPX	26	29	100	5,2

WALL-MOUNTED HANDS-FREE HYGIENIC STATION

For optimal hygiene.

Stainless steel



Réf.				
SHMX	11,5	13	32,5	1,8

DISPENSER BOX FOR DISPOSABLE INSTITUTIONAL PEAKED CAPS - NF

Screws and dowels

Stainless steel



Réf.					
B1000.	26	10,5	28	3	For boxes of mob caps

DISPENSER BOX FOR DISPOSABLE MASKS - NF

Screws and dowels

Stainless steel



Réf.				
B1010.	8,7	4,7	26	0,52

DISPENSER BOXES FOR DISPOSABLE CAPS - NF

Screws and dowels

Stainless steel



Réf.					
B1020.	29,5	10,5	14,5	1,8	For boxes

DISPENSER BOXES FOR DISPOSABLE GLOVES - NF

Screws and dowels

Stainless steel



Réf.					
B1030.	25	14	9	1,5	Down supply
B1035.	25	13,5	8	1	Front supply

The dimensions are expressed in cm, the weight in kg.
www.louistellier.fr

DISPENSER BOX FOR DISPOSABLE INSTITUTIONAL PEAKED CAPS - NF

- Screws and dowels
- Stainless steel



Réf.					
B1050.	31	27,7	19,5	6	For box of unwoven clip-held mob caps

DISPENSER BOXES FOR VISITOR'S KIT - NF

To be screwed directly to the wall.

- Screws and dowels
- Stainless steel



Réf.					
B1060.	12,3	10,4	43,5	2	

WALL-MOUNT BOX HOLDER FOR CAPS DISPENSER

For optimal hygiene.

- Stainless steel



Réf.					
B1000E	25,3	10,2	27,3	0,92	

WALL MOUNT BOX HOLDER FOR MASKS

For optimal hygiene.

- Stainless steel



Réf.					
B1010E	8,7	4,7	25,8	0,33	

WALL MOUNT BOX HOLDER FOR PAPER CAPS

For optimal hygiene.

- Stainless steel



Réf.					
B1020E	29,7	9,6	13	0,55	

WALL MOUNT BOX HOLDER FOR GLOVES

For optimal hygiene. Front exit.

- Stainless steel









Réf.					
B1035E	23	8	13	0,4	

SCRAPER FOR OVEN

 Stainless steel brush, wooden handle

BEST SELLER



Réf.					
NBR01	 28	3,5	5,5	0,12	Long handle
NBR02	17	6,5	8	0,3	Short handle



SHARING

RACLETTE AND FONDUES	165
BRASEROS AND PLANCHETTAS	171
SKEWERS	174
FOOD SMOKERS	176



RACLETTE APPLIANCE BRÉZIÈRE® THE SIGNATURE RANGE



LOUIS TELLIER
BIEN NE REMPLACE LE FAIT MAINT



Made in France

Foldable model with transport hook: space-saving, easy to store and easy to put into service



Suitable for **1/4** to **1/6** cheese wheel, i.e. 1 to 4 people



Robust: In **stainless steel** and epoxy painted **steel** for the colors



2 Height-adjustable heating ramps to adapt to the cheese portion

Removable stainless steel cheese holder: dishwasher safe

2,20 m cord

In the purest of traditions, Brèzière raclette appliances can be combined with different types of cheese, such as raclette cheese, plain, smoked, with peppers, the morbier, etc.

Accessories are also available for your reblochonnades (x2 ref. : REB02 or x1 ref. : REB03)

The special CAR01 raclette knife, essential for scraping and cutting your grilled cheese, is sold separately.

Find the colour variation of the Signature range on Alpage® appliances.

RACLETTE APPLIANCE - BRÉZIÈRE® - SIGNATURES - ORIGINAL

The Original in its textured bronze color, suitable to the number of the guests (from 1 to 4 persons). Revolving heating cases according to the size of the round cheese: from 1/6 to max 1/3 round cheese. Foldable device: reduced size. Removable St cheese holder.

Ignition switch. Carry handle. Removable cheese holder and dishwasher safe. Electric cord: 2,20 m.

Stainless steel, epoxy painted steel

850 W - CE - 230 V



Réf.					
BREZ01	44,5	21,5	30	3,46	Brézière® 230V
BREZ01C	44,5	21,5	30	3,55	BREZ01 230V + CAR01
BREZ02	44,5	21,5	30	3,46	Brézière® 110V
BREZ02C	44,5	21,5	30	3,55	BREZ02 + CAR01
BREZ03	44,5	21,5	30	3,46	BREZ01 + UK plug
BREZ04	44,5	21,5	30	3,46	BREZ01 + Swiss plug

RACLETTE APPLIANCE - BRÉZIÈRE® - SIGNATURES - BASALTE

Basalt, black color, for a modern style, is Up to 6-8 persons. Horizontal heating case adjustable in height. Inclunable cheese holder, fast dismantling. Ignition switch.

Ignition switch. Carry handle. Removable cheese holder and dishwasher safe. Electric cord: 2,20 m.

Stainless steel, epoxy painted steel

850 W - CE - 230 V



Réf.					
BREZ01BA	44,5	21,5	30	3,46	Brézière® 230V

RACLETTE APPLIANCE - BRÉZIÈRE® - SIGNATURES - ST/ST

The Inox, all stainless steel material and color with solid beech handle, for a classic chic style, is Up to 6-8 persons. Horizontal heating case adjustable in height. Inclunable cheese holder, fast dismantling. Ignition switch.

Ignition switch. Carry handle. Removable cheese holder and dishwasher safe. Electric cord: 2,20 m.

Stainless steel

850 W - CE - 230 V



Réf.					
BREZ01NX	44,5	21,5	30	3,46	Brézière® 230V

RACLETTE APPLIANCE ALPAGE® - SIGNATURES - ORIGINAL

The Original, textured bronze color, for a traditional style, is Up to 6-8 persons. Horizontal heating case adjustable in height. Inclunable cheese holder, fast dismantling. Ignition switch.

Cable: 2,20 m

Stainless steel, epoxy painted steel

850 W - 230 V



Réf.					
RACL01	46	26,5	40	3,76	230 V - 850 W
RACL02	46	26,5	40	3,76	110 V - 900 W
RACL02C	46	26,5	40	3,84	RACL02 + CAR01
RACL03	46	26,5	40	3,76	RACL01 + UK plug

RACLETTE APPLIANCE ALPAGE® - SIGNATURES - BASALTE

Basalt, black color, for a modern style, is Up to 6-8 persons. Horizontal heating case adjustable in height. Inclinable cheese holder, fast dismantling. Ignition switch.

Stainless steel, epoxy painted steel

850 W - 230 V



Réf.					
RACL01BA	44,5	21,5	30	3,55	230 V - 850 W

RACLETTE APPLIANCE ALPAGE® - SIGNATURES - ST/ST

The Inox, all stainless steel material and color with solid beech handle, for a classic chic style, is Up to 6-8 persons. Horizontal heating case adjustable in height. Inclinable cheese holder, fast dismantling. Ignition switch.

Stainless steel

850 W - 230 V



Réf.					
RACL01NX	46	26,5	40	3,55	230 V - 850 W

REBLOCHONNADE KIT FOR ALPAGE®

To cook 2 reblochon cheeses. Accessories designed for ALPAGE® devices to vary recipes.

2 saucepans + 2 spatulas + 1 holder

Stainless steel plate



Réf.					
REB01	53	26,5	40	1,88	RACL01 / RACL02 / RACL02C / RACL03

REBLOCHONNADE KIT FOR BRÉZIÈRE®

To cook 2 reblochon cheeses. Accessories designed for Brézière® devices to vary recipes.

2 saucepans + 2 spatulas + 1 holder

Stainless steel plate



Réf.					
REB02	32	14	11	1,9	BREZ01 / BREZ02 / BREZ03

REBLOCHONNADE-RACLETTE KIT FOR BRÉZIÈRE®

To cook 1 piece of raclette cheese on one side and a reblochon on the other side. Accessories designed for Brézière® devices to vary recipes.

1 saucepan + 1 spatula + 1 holder

Stainless steel plate



Réf.		
REB03	0,76	BREZ01 / BREZ02 / BREZ03

SKEWER KIT FOR ALPAGE®

To cook 2 skewers at each time and to roast hot bread toast with melted cheese. Accessories designed for ALPAGE® devices to vary recipes.

1 holder + 4 skewers 40 cm long

Stainless steel plate and skewers

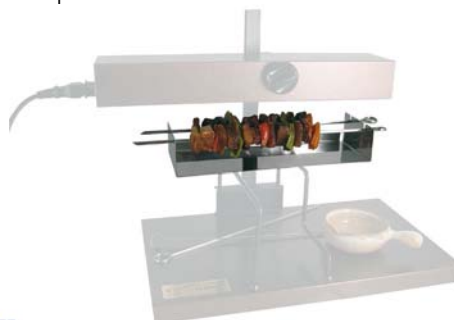

Réf.					
BROCH01	40	12	6	0,52	RACL01 / RACL02 / RACL02C / RACL03

RACLETTE KNIFE

1 smooth side to scrape and 1 microtoothed side to cut «religieuses».

Tempered Stainless steel blade, varnished wooden handle, brass rivets



Réf.				
CAR01	24	4,5	1,5	0,08



POTATOES HOLDER PICKER

To hold a potato without getting burnt whilst peeling.

Stainless steel tip, wooden handle

Réf.				
N4504	12,5	2	2	0,02



POTATOES BUCKET

To keep potatoes warm during raclette or fondue's times.

White natural wood



Réf.							
SEP-OC	30	20	14,5		0,92	Oval with lid	
SEP-RC				21,5	20	0,68	Round with lid
SEP-R			20	18	0,53	Round without lid	



CHEESE MELTER WITH BURNER

With burner. Tilting tray.

1 burner

Non-stick bilayer, stainless steel



Réf.				
TTM03	15/21	30	15	1,75



«PARTY» TRADITIONAL RACLETTE

For 1/4 round cheese. Up to 4 persons. Electric cord lenght: 1,10m.

Powder coated steel, rotating tray and handle, chrome steel support and high temperature coating body

600 W



Réf.					
TTM05	28	24	34	2,7	230V.
TTM05C-110	29	24	32	2,8	110V.



«AMBIANCE» TRADITIONAL RACLETTE

For 1/2 cheese wheel. Up to 6-8 persons.

Powder coated steel, rotating tray and handle, chrome steel support and high temperature coating body

1000 W



Réf.					
TTM10	48,5	28	32	5,7	230V.
TTM10C-110	48,5	28	32	5,61	110V.



TRADITIONAL RACLETTE FOR 2 HALF-WHEELS

To serve raclette continuously.

Powder coated steel, rotating tray and handle, chrome steel support and high temperature coating body

1000 W



Ref.					
TTM20	54	29	33	7,4	230V.

TRADITIONAL RACLETTE FOR 3 HALF-WHEELS

To serve raclette continuously.

Epoxy painted steel base, nickel-plated steel support, blackened steel heating body (phosphating)

2000 W - 230 V



Ref.					
TTM30	54	47	34	10,4	

RACLETTE OVEN + GRILL FOR 6

Delivered without raclette spatula. Up to 6 people.

6 saucepans

Non-stick plate, wooden handle pan

900 W - 230 V



Ref.				
TTM40CE	28	13	1,94	

RECTANGULAR SAUCEPAN - WOODEN HANDLE

Sold individually.

Non-stick, wooden handle



Ref.				
TTM02-PB	19	8,5	1,5	0,08

PROFESSIONAL RACLETTE APPLIANCE

All st/st for professional quality, robust and durable over time. Ultra non-stick baking sheet, «Obsidian» technology for vegetables, meats, etc.. Plug to connect several appliances (recommended max. 3). ignition switch. Practical and user-friendly with its 4 saucepans and its rectangular shape.

4 non-stick saucepans, plastic handle + 4 beech wood spatulas PEFC certified included.

Stainless steel + non-stick plate

600 W - 230 V



LOUIS TELLIER

Ref.					
RACP01NX	51	10	12	2,9	230V - 600W

CONNECTION CABLE «LE CONVIVAL»

Connection cable between the «Professional Raclette Appliance»

Elastomer and PVC



LOUIS TELLIER

Ref.					
5013	4	0,11	40 cm		RACP01NX
5029	4	0,12	70 cm		RACP01NX

FONDUE SET «PINETREE»

Kit fondue up to 6 people, the cast iron cauldron is suitable for all types of fondues.

2,5 L

1 stove, 1 burner, 1 decorative plate for stove RECH-PS, 1 cauldron CHAUD01, 6 «arobase» fondue fork FFO6.

Fondue burner epoxy painted steel, stainless steel decorative plate, enamelled cast iron cauldron



Réf.				
RECH02-KIT	28	21	25	5,23

FONDUE STOVE «PINETREE»

Lockable higher plate.

Fondue burner epoxy painted steel, stainless steel decorative plate



Réf.				
RECH02	22	12	1,43	CHAUD01 / RECH02-KIT

CHINESE «FONDUE» LADLES

Set of 4.

Coloured identification clips

Stainless steel



Réf.			
NC8090660	6	3,5	0,18

ELECTRIC CHINESE FONDUE APPLIANCE

Pot for the Chinese fondue: the hot broth cooks vegetables, vermicelli and thin slices of meat or fish.

3,5 L

6 TTMFC-P6 strainers and 1 recipes booklet

Hammered and tinned solid copper, wooden handles

1200 W - 230 V

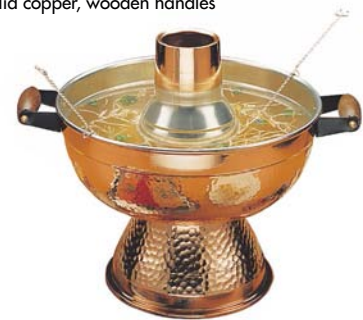

Réf.			
TTMFC01	30	32,5	3,77

TATAR HAT - MODEL WITH BURNER

Appliance to grill thin slices of meat, fish, vegetables and fruits on the cone-shaped hat equipped with pikes. No smoke, no juices that reduce to carbon. Juices flow to the edge of the hat where you place a clear soup with sliced vegetables. No fragility to the thermic shocks.

3 burners

Enamelled iron sheet hat



Réf.			
TTM80AL	30	34	2,1

TATAR HAT - ELECTRIC MODEL

Appliance to grill thin slices of meat, fish, vegetables and fruits on the cone-shaped hat equipped with pikes. No smoke, no juices that reduce to carbon. Juices flow to the edge of the hat where you place a clear soup with sliced vegetables. No fragility to the thermic shocks.

4 TTM80ECP saucepans.

Non-stick coated steel hat

1200 W - 230 V



Réf.			
TTM80E	30	30	2,5

BRASERO - TABLE BARBECUE



Professional quality and robustness:
 - **18/10 stainless steel** = does not rust
 - Thick **polished stainless steel** grill:
 non-deformable and reduces food adhesion

SHARING



Fully **dismountable**
for easy cleaning

Perfect stability for more security
= thanks to its weight
and **solid beechwood tray**

Lower insert for reserving
or heating dishes or pan

Functional :

- Lighting speed: ready to use in **10 min - 20 min** for embers
- 1 **removable** charcoal burner for preheating or reserving the embers out of the table
- + 1 ignition gel receptacle **to boost** the ignition

This outdoor barbecue can be placed in the center of a table to cook rib of beef, fish, skewers, etc. on a lawn, around the swimming pool, at the foot of your fishing rods, etc. anywhere you want according to your imagination!

It has only one side open to avoid catching the wind for optimum safety.

It is easy to store because of its size and its square block.

TABLE BARBECUE WITHOUT HEARTH FOR SKILLET

For cooking thin slices of meat on charcoal. The barbecue can be lighted on a gascooker (perforated bottom's hearth). Removalbe hearth. Manufactured in compliance with NF standards.

4 rubber feet

Epoxy painted steel, base in massive beech wood



LOUIS TELLIER

Réf.				
BRAS01	29	18	21,7	6,98

COMBINED BARBECUE/REBLOCHONNADE - «EDELWEISS»

For cooking thin slices of meat on charcoal. The barbecue can be lighted on a gascooker (perforated bottom's hearth). Removalbe hearth.

1 steel frying pan + 1 composite spatula (480°F)

Epoxy painted steel, base in massive beech wood



LOUIS TELLIER

Réf.				
BRAS-REB02	33	21,5	21,8	7,13

BRASERO - TABLE BARBECUE

Ideal for outdoor grilling (prime rib, fish...).Removable fireplace to light the charcoal and reserve the embers. Fully removable for easy-care. Professional quality

Stainless steel



LOUIS TELLIER

Réf.					
BRASI-F	32	22	21,5	7,3	Outdoor use : 1 open side

BRASERO - COMBINED BARBECUE - KIT REBLOCHONNADE

Perfect for your reblochade or grilling indoors! User-friendly with its 2 open sides for inserting the pan. Removable fireplace to preheat the embers. Fully removable for easy maintenance.

Reblochade KIT: 1 steel pan + 1 composite spatula

Stainless steel



LOUIS TELLIER

Réf.					
BRASI-O	32	22	21,5	7	Outdoor use : 2 open sides

PLANCHETTA



LOUIS TELLIER

BIEN NE REMPLACE LE FAIT, MAINT



Made in France

Ideal for **indoor** and **outdoor** use

No juice **leakage**: the enamelled plate is slightly tapered to a «diamond tip»

Unbreakable plate in enamelled steel



Wooden base

Delivered with **2 burners** but with spaces for **3**, for more powerful heating



Rapid heating by burners: **10 minutes**

With this planchetta, you can grill your meat at the table.
Windshield accessories (PLAN-PV) in stainless steel available for outside use.

PLANCHETTA 4 PEOPLE - WOODEN BASE

The upper plate is perforated at the center to let the greases flow in the container provided. For 2 to 4 servings. Enamelled unbreakable plate. Fast heating.

2 burners + 1 st/st container for flowing fats

Ceramic plate, wooden base, stainless steel



LOUIS TELLIER

Réf.				
PLAN01	33	22	14	4,4

PLANCHETTA 4 PEOPLE - METAL BASE

The upper plate is perforated at the center to let the greases flow in the container provided. For 2 to 4 servings. Enamelled unbreakable plate. Fast heating.

2 burners + 1 st/st container for flowing fats

Ceramic plate, metal base, stainless steel



LOUIS TELLIER

Réf.				
PLAN02	34,5	22	10	3,41

PLANCHETTA 2 SERVINGS

The plate is slightly curved in «diamond tip» (not perforated) to prevent the juices from flowing on the edges. For 2 to 4 servings. Enamelled unbreakable plate. Fast heating.

2 burners

Ceramic plate, wooden base, stainless steel



LOUIS TELLIER

Réf.				
PLAN05	37	17	14	3,72

TONGS FOR PLANCHETTAS

Tongs to grab the hot ceramic plate of the planchettas.

Stainless steel



LOUIS TELLIER

Réf.					
PLAN-P	23	5	2	0,11	PLAN01 / PLAN02 / PLAN05

WIND PROTECTOR FOR PLANCHETTA - SET OF 2

To optimize the use of planchettas outdoors: protects the stoves from the wind and ensure a continuous heating.

Stainless steel



LOUIS TELLIER

Réf.					
PLAN-PV	10	9	0,32		PLAN01 / PLAN02 / PLAN05

GRILL STONE WITH SUPPORT

To cook thin slices of meat, fish, vegetables or fruits. The stone can be warmed in an oven (300°C / 520°F max).

1 burner

Natural soapstone, chrome steel wire support, wooden handles



LOUIS TELLIER

Réf.					
PIER01	35,5	26,5	13,5	5,81	25 x 25 cm.
PIER03	27,5	18,5	13,5	2,97	17 x 17 cm.

The dimensions are expressed in cm, the weight in kg.
www.louistellier.fr

STONE FOR GRILL

To cook thin slices of meat, fish, vegetables or fruits. The stone can be warmed in an oven (300°C / 520°F max).

Natural ollaire stone

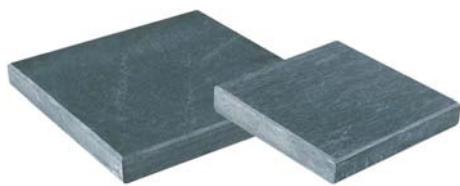

Ref.	Length	Width	Height	Weight	Dimensions	Accessories
PIER17	17	17	3	2,3	17 x 17 cm.	SUP03
PIER25	25	25	3	4,8	25 x 25 cm.	SUP01

SUPPORT FOR GRILL STONE

Baking stone holder in steel wire. Burner not included.

Chrome steel wire, wooden handles



Ref.	Length	Width	Height	Weight	Dimensions	Accessories
SUP01	35,5	26,5	13,5	0,54	For stone 25 x 25 cm	PIER25
SUP03	27,5	18,5	13,5	0,48	For stone 17 x 17 cm	PIER17

TONGS FOR GRILL STONES

Tong opening: 30 mm. To handle the grill stones when leaving the oven.

Stainless steel



Ref.	Length	Width	Height	Weight	Dimensions	Accessories
PIER-P	21,5	6,5	3,5	0,15	PIER01 / PIER03 / PIER25 / PIER17	

SKEWER HOLDER FOR 2 SKEWERS

Stainless steel



Ref.	Length	Width	Height	Weight	Dimensions	Accessories
NC052	22	45	0,5		With 2 skewers	
NC4250060	22	45	0,46		Without skewer	

SKEWER HOLDER FOR 4 SKEWERS

Stainless steel



Ref.	Length	Width	Height	Weight	Dimensions	Accessories
NC4250460	22	45	0,5		Without skewer	

WROUGHT IRON SKEWERS HOLDER WITH WOODEN BASE

Supports up to 2 skewers max 40 cm. Possibility to put a plate on the wooden base: Ø max plate heel 22 cm, plate Ø 30 cm max. Sold without skewer.

Wrought iron, wooden base



Ref.	Length	Width	Height	Weight	Dimensions	Accessories
POBN01	31	27	43	1,06	Single	PIC25 / PIC30 / PIC35 / PIC40
POBN01V	31	27	43	6,39	Set of 6 in bulk	

ST/ST SKEWERS HOLDER WITH WOODEN BASE

Supports up to 2 skewers max 40 cm. Possibility to put a plate on the wooden base: Ø max plate heel 22 cm, plate Ø 30 cm max. Sold without skewer.

Stainless steel, wooden plate



Ref.						
POBX01	31	27	43	0,91	Single	PIC25 / PIC30 / PIC35 / PIC40
POBX01V				0,82	Set of 6 in bulk	

ST/ST SKEWERS HOLDER WITH BASE AND DIP SUPPORTS

Supports up to 2 skewers max 40 cm. Possibility to put a plate on the wooden base: Ø max plate heel 22 cm, plate Ø 30 cm max. Sold without skewer. Inside diameter of ramekins Ø 9 cm.

2 dip holders
 Stainless steel, wooden plate



Ref.					
POBX01-S	31	27	43	0,96	

MEDIEVAL WROUGHT IRON SKEWERS HOLDER

Support for 1 sword skewer. Sold without skewer.

Metal



Ref.						
POBE01	31	26	43	0,85	Metal base	BROCH02
POBE02	31	27	44	0,98	Wooden base	BROCH02

MEDIEVAL ST/ST SKEWERS HOLDER - CENTRAL BRACKET

Medieval stainless steel skewer holder, support with offset mast to raise the skewers.

4 skewers BROCH02 and 4 St/St ramekins
 Stainless steel, varnished wood plate



Ref.				
POBX4C	21	54	1,41	

SHARING

MEDIEVAL ST/ST SKEWERS HOLDER - SHIFTED BRACKET

Medieval stainless steel skewer holder, support with offset mast to raise the skewers.

4 skewers BROCH02
 Stainless steel, varnished wood plate, aluminium



Ref.				
POBX4D	26,5	58,5	1,48	

PLATE SKEWERS HOLDER WITH SKEWERS (SET OF 6)

For an original presentation on the plate, with one or several skewers using clip-on supports.

6 skewers of 25 cm
 Stainless steel



Ref.				
PBC06C	24	20,5	5	0,19

SKEWERS FRAME

The skewer support is fixed to the base with magnets on both sides : stability. Vertical skewer service on a board: cleanliness and hygiene. Allows individual table service. Spots for 5 skewers of 25 cm max. Sold without skewer neither ramekins.

- Channel and magnetic feet
- Stainless steel, wood



Ref.						
PORT01	46	12	28,5	0,61	Wooden base	PIC25
PORT02	46	12	27	0,49	Papperstone® base	PIC25

MEDIEVAL «SWORD» SKEWER

Useful lenght: 35 cm.

- Stainless steel, aluminium head



Ref.						
BROCH02	47	8	1	0,13	POBE01 / POBE02 / POBX4C / POBX4D	

GIANT SKEWER

Useful lenght: 38 cm.

- Stainless steel



Ref.				
BROCH01-G	50	0,1		POBF01-G

COLD SMOKER

For fishes (salmons, trout, eel...), vegetables, shellfishes, duck breast fillets, poultries, saucissons, cheeses...

- 600x400 sieve
- Stainless steel



Ref.						
FAFR	75	42	17,6	15		With resistance
FAF	75	42	17,6	15		Without resistance

LIGHTER SAWDUST

Combining sawdust in no time! (5 minutes are enough) Suitable for cold smoker: its fineness allows it to slip into the sawdust tank and not let the smoke escape.

- 30 minutes timer
- Stainless steel housing
- 150 W



Ref.					
FAF01	39,5	7	12		FAF

COLD SMOKER



The cold smoker is ideal for removing water from products (fish, vegetables, shellfish, duck breast, poultry, sausages, cheeses, etc.) without drying them out.

Two models available : with and without resistance.



NON-STICK

BAKING TRAYS	181
BREAD MOULDS AND BAKING TRAYS	184
PIZZA MOULDS AND OVEN ROASTING PAN	186
FOLDING LOAF CAKE MOULD	187
CAKE MOULDS	188
BRIOCHE MOULDS	189
ROUND PLAIN TART MOULDS	191
ROUND CAKES & MILLASSON MOULDS	198
BAKING SHEETS	200
SAVARIN, CHARLOTTE AND THEME MOULDS	201
INDIVIDUAL BITES & CAKES	204
RECIPES & KIT PACKS	207
PROFESSIONAL MULTI BAKING TRAYS	209

FRANCE 1887
GOBEL[®]

rien ne remplace le fait main

NON-STICK COATING

«THE EASY WAY»

EASY AND QUICK DEMOULDING

- Fat-free, perfect demoulding
- Two-layer non-stick coating, guaranteed PFOA-free, professional quality

VERY GOOD DISTRIBUTION HEAT

- Impeccable and uniform cooking
- Good conduction by its non-stick coated steel material

RESISTS HIGH TEMPERATURES

- Heating temperature up to 250°C
- Mould thickness of 0.5 mm : best compromise between robustness and cooking qualities



CHEF'S ADVICE

To keep the quality of the non-stick coating, avoid scratches. Thus favor a cut of the preparation outside the mould.

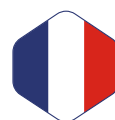

Made in France



MAINTENANCE

- Clean before first use
- Prefer hand washing
- Wash with soapy water

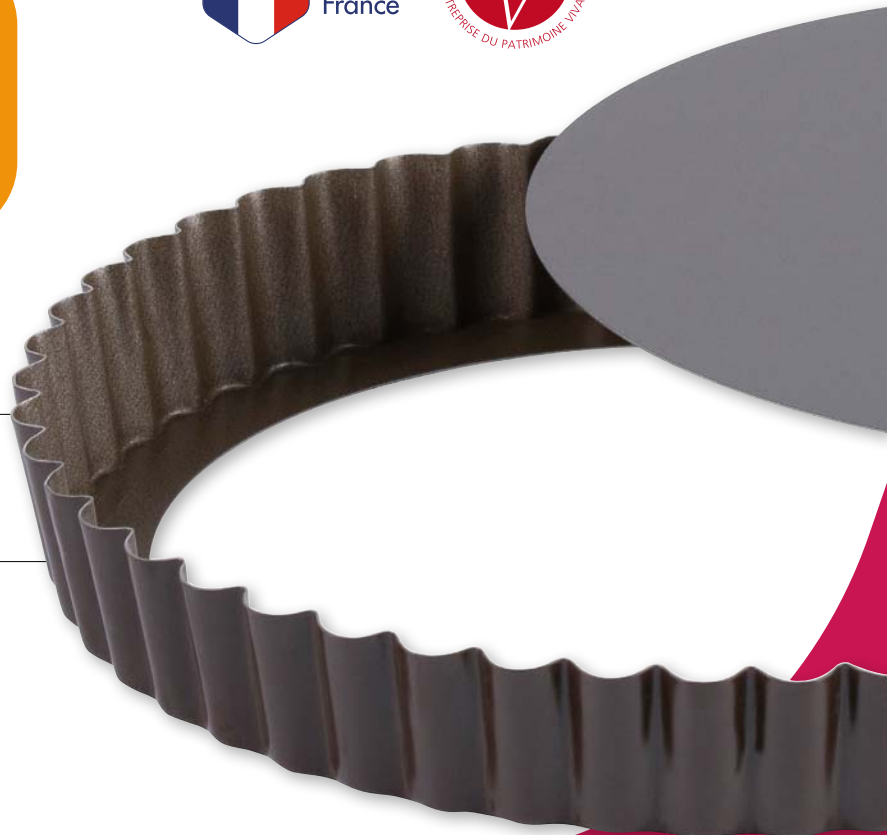

6 XXL MADELEINES BAKING SHEET

For XXL madeleines. Cavities : 106 x 66 mm.

Two-coat non-stick



GOBEL

Ref.					
264810	39,5	20	1,7	0,4	5/10

12 MADELEINES BAKING SHEET

Rolled edges. Cavities : 8 mm each.

Two-coat non-stick



GOBEL

Ref.					
264710	39,5	20	1,7	0,4	5/10

20 SMALL MADELEINES BAKING SHEET

Cavities : 42 mm each - rolled edges.

Two-coat non-stick



GOBEL

Ref.					
264510	39,5	12,5	1,3	0,23	5/10

12 MUFFIN BAKING SHEET

Rolled edge. Cavity : 67 x 67 x 30 mm.

Two-coat non-stick



GOBEL

Ref.					
296513	35,5	27,2	3,4	0,45	5/10

8 ECLAIRS BAKING SHEET

8 éclairs in a batch! Ideal for party aperitifs, afternoon teas and cafés gourmands.
8 cavities : 12 x 35 x 4.8 mm each

Two-coat non-stick



GOBEL

Ref.					
298510	31,5	22,8	0,5	0,93	5/10

6 FINANCIERS BAKING SHEET

Stamped - 6 cavities : 98 x 48 mm each

Two-coat non-stick



GOBEL

Ref.					
220710	38	18	1,3	0,31	5/10

NON-STICK

MINI-FINANCIERS OR BISCUITS ROSE DE REIMS BAKING SHEET

Stamped - 2 rows of 6 cavities of 75 mm each

Two-coat non-stick

GOBEL

Ref.					
267030	29	19,8	1,7	0,31	5/10

12 BARQUETTES PAN

12 casings in a batch! Ideal for party aperitifs and cafés gourmands.

Two-coat non-stick

GOBEL

Ref.					
298410	32	23,5	0,5	0,33	5/10

12-CUP TARTLET PAN

12 cavities : Ø 8 mm. Easy to unmold.

Two-coat non-stick

GOBEL

Ref.					
228310	32	24,5	1	0,35	5/10

DOUGH PUSHER

Beechwood

GOBEL

Ref.				
319110	4/5,5	7	0,04	228310 / 293610 / 293620

DENT DE LOUP MOULD

Count 20 cookies per tray. Easy to unmold.

Two-coat non-stick

GOBEL

Ref.					
220510	30	29	2,5	0,62	5/10

ROUNDED BISCUIT SHEET

Easy to unmold.

Two-coat non-stick

GOBEL

Ref.					
258130	35	24	0,62	5/10	

SWISS ROLL TIN

Stamped. Raised edges.

 Two-coat non-stick



GOBEL

Ref.						
221110 	37	27	2,1	0,53	Delivery time : 5 weeks	5/10

NON-STICK

FRENCH THIN BAGUETTE BAKING TRAY

Easy to unmold. 4 imprints.

Two-coat non-stick



GOBEL



Réf.					
258230	35	24	0,55		5/10

4 FRENCH BAGUETTE BAKING PAN

Easy to unmold. 4 imprints.

Two-coat non-stick



GOBEL



Réf.					
258330	38	32	2,7	0,62	5/10

2 FRENCH BAGUETTE BAKING PAN

Easy to unmold. 2 imprints.

Two-coat non-stick



GOBEL



Réf.					
258320	38	16	2,2	0,3	5/10

FRENCH BAGUETTE PERFORATED BAKING PAN

2 imprints. Easy to unmold. Perforations promote hot air circulation and allow excess moisture to escape for even cooking and a crispy crust.

Two-coat non-stick



GOBEL



Réf.					
258321	38	16	2,2	0,3	5/10

2-BREAD BAKING TRAY

Easy to unmold. 2 imprints.

Two-coat non-stick



GOBEL



Réf.					
258430	38	21	0,41		5/10

MINI-BUNS BAKING SHEET PAN

Ideal for mini-burger, blinis, mini-cookies, macaroons... 18 cavities : Ø 4 mm h 5 mm each.

Two-coat non-stick



GOBEL



Réf.					
298610	34,5	18	0,5	0,25	5/10

BUNS BAKING MOULDS

Easy to unmold.

Two-coat non-stick



GOBEL

Réf.	∅	I	W	Weight	> <
210910	10	2	0,06		5/10

BOX SET OF 4 BUNS BAKING MOULDS

Two-coat non-stick



GOBEL

Réf.	∅	I	W	Weight	> <
282580	12	9	0,26		5/10

PERFORATED BREAD PAN

Easy to unmold. Perforations promote hot air circulation and allow excess moisture to escape for even cooking and a crispy crust.

Two-coat non-stick



GOBEL



Réf.	∅	L	I	W	Weight	> <
223690	27/25	10,5/8	8	0,35		5/10
234010	16/14	10/8	7	0,22		5/10

ROUND BREAD MOULD

Easy to unmold.

Two-coat non-stick



GOBEL



Réf.	∅	I	W	Weight	> <
235010	23/20	6	0,31		5/10
235020	27/23,5	6	0,38		5/10

SOFT BREAD PAN WITH SLIDING LID

Easy to unmold.

Two-coat non-stick



GOBEL



Réf.	L	I	W	Weight	> <
219010	40/39,5	10,5/10	9	1,1	5/10
219310	25/24,5	9,3/8,4	7,6	0,63	5/10

SURPRISE BREAD MOULD

Easy to unmold.

Two-coat non-stick



GOBEL



Réf.	L	I	W	Weight	> <
219050	20	20	19	1	5/10

NON-STICK

GOBEL PIZZA MOULD

Two-coat non-stick

BEST SELLER



GOBEL

Réf.	∅	I	📦	> <
227005	15,5/14,7	1,2	0,12	5/10
227010	24/23	1,3	0,24	5/10
227020	30/29	1,3	0,35	5/10
227030	34/33	1,3	0,42	5/10

GOBEL PERFORATED PIZZA PAN

Perforations promote hot air circulation and allow excess moisture to escape for even cooking.

Two-coat non-stick

BEST SELLER



GOBEL

Réf.	∅	I	📦	> <
227120	30/29	1,5	0,34	5/10
227130	34/33	1,5	0,42	5/10

MINI OVEN ROASTING PAN

Two-coat non-stick

BEST SELLER



GOBEL

Réf.	↔	↗	I	📦	> <
231010	24,5	18,5	4,5	0,33	5/10

ROASTING PAN

Two-coat non-stick



GOBEL

Réf.	↔	↗	I	📦	> <
231020	32	22	5	0,49	5/10

NON-STICK

LONG PLAIN LOAF PAN (MINI)

Easy and practical unmoulding thanks to the hinge and the removable bottom.

Two-coat non-stick



GOBEL

Ref.					
219410	30	4	6	0,37	5/10
219440	50	4	6	0,57	5/10

LONG PLAIN LOAF PAN

Easy and practical unmoulding thanks to the hinge and the removable bottom.

Two-coat non-stick



GOBEL

Ref.					
219710	30	8	8	0,53	5/10
219720	35	8	8	0,6	5/10
219730	40	8	8	0,67	5/10
219740	50	8	8	0,8	5/10

FOLDING LOAF PAN OR CAKE MOULD

Edged on wire for strength and durability over time. Ceramic reinforced two-layer non-stick.

Two-coat non-stick



GOBEL

Ref.					
220010	24/22	9,5/8	7	0,35	5/10
220020	27/25	10/9	7,5	0,42	5/10
220030	30/28,5	10/9	7,5	0,46	5/10

NON-STICK

STAMPED CAKE MOULD

Stamped, rolled edges. Easy to unmold.

Two-coat non-stick

GOBEL

Réf.					
223320	26/23	9,5/6,5	7,5	0,28	5/10
223330	28/25	10/7,5	7,5	0,31	5/10

STAMPED SINGLE SERVING CAKE MOULD

Easy to unmold.

Non-stick coated aluminium

GOBEL

Réf.					
722630	10	3,8	3,5	0,04	10/10

BOX SET OF 6 SINGLE SERVING CAKES

Non-stick coated aluminium

GOBEL

Réf.					
726630	13	7	8	0,19	10/10

RAISED REINFORCED EDGE WITH WIRE CAKE MOULD

Easy to unmold.

Two-coat non-stick

GOBEL

Réf.					
222630	10/9	4,5/3,2	4	0,05	5/10
223610	15/13	7/5	5,5	0,2	5/10
223620	18/15,7	8/5,7	6,5	0,2	5/10
223630	21/18,5	9/6,5	7	0,26	5/10
223640	24/21,5	9/6,5	7	0,4	5/10
223650	27/24,2	10,5/7,7	8	0,4	5/10
223660	30/27,2	10,5/7,7	8	0,4	5/10
223670	33/30,2	10,5/7,7	8	0,4	5/10
223680	36/33,2	10,5/7,7	8	0,46	5/10

SMALL BRIOCHE - 10 RIBS

Flat bottom.

Two-coat non-stick



GOBEL

Réf.				
293730	7,5/4	3	0,03	5/10

BRIOCHE - 10 RIBS

Flat bottom.

Two-coat non-stick



GOBEL

Réf.				
293740	8/4	3,5	0,04	5/10
293750	9/4,5	3,5	0,04	5/10
293760	10/5,5	4	0,05	5/10
293770	11/5,5	4,2	0,06	5/10

BRIOCHE - WIDE RIBS

Flat bottom.

Two-coat non-stick



GOBEL

Réf.				
223010	14/7,3	4,8	0,12	5/10
223020	16/8,3	5,5	0,15	5/10
223030	18/9,1	5,6	0,18	5/10
223040	20/9,7	7,5	0,24	5/10
223050	22/9,9	9	0,3	5/10
223060	24/10	10	0,35	5/10

BOX SET OF 6 SMALL BRIOCHE MOULDS

Brioche Ø 80/40 H 32 mm

Two-coat non-stick



GOBEL

Réf.				
271641	17	3,6	8,5	0,22

SMALL BRIOCHE - 9 RIBS

Flat bottom.

Two-coat non-stick



GOBEL

Réf.				
293710	6/2,8	2,5	0,03	5/10
293720	7/3,7	2,8	0,03	5/10

EMPTY CDU FOR SMALL BRIOCHE MOULDS

Offered for setting up 24 brioches moulds.

Paper



GOBEL

Réf.			
307139	26	20	36

TART MOULD



Two-layer non-stick
professional quality allowing
a perfect demoulding

Removable bottom:
100% easy to remove
from the mould



Perforated bottom:
even heat distribution,
perfect for thick preparations

Since 1887, Gobel non-stick has been recognized for:

- Its excellent non-stick properties: much more efficient than a monolayer and ensures perfect release.
- Its good resistance to abrasion: the two-layer finish makes it possible to load the layer superior in mica and makes it less fragile.
- Its longevity: a greater thickness of the coating ensures an increased longevity.

ROUND FLUTED TART MOULD WITH FLAT EDGE

Fixed bottom. Homogeneous cooking.

Two-coat non-stick



GOBEL

Réf.	Ø	I	📦	> <
226120	26/23	3	0,3	5/10

ROUND FLUTED TART MOULD

Fixed bottom. Homogeneous cooking.

Two-coat non-stick



GOBEL

Réf.	Ø	I	📦	> <
226320	20/18,5	2,8	0,17	5/10
226322	22/20	2,5	0,22	5/10
226330	24/23	2,8	0,25	5/10
226332	26/24	2,5	0,29	5/10
226340	28/27	2,8	0,33	5/10
226342	30/28	2,5	0,37	5/10
226350	32/31	2,5	0,42	5/10

ROUND FLUTED TART MOULD - REMOVABLE BOTTOM

Loose bottom.

Two-coat non-stick



GOBEL

Réf.	Ø	I	📦	> <
226420	20/18,5	2,5	0,19	5/10
226422	22/20	2,5	0,22	5/10
226430	24/23	2,8	0,26	5/10
226432	26/24	2,5	0,3	5/10
226440	28/27	2,8	0,35	5/10
226442	30/28	2,5	0,38	5/10
226450	32/31	2,8	0,43	5/10

DEEP ROUND FLUTED TART MOULD

Fixed bottom. Homogeneous cooking.

Two-coat non-stick



GOBEL

Réf.	Ø	I	📦	> <
226520	20/18,5	3,5	0,2	5/10
226522	22/20	3,5	0,24	5/10
226530	24/22,5	3,5	0,27	5/10
226532	26/24	3,5	0,31	5/10
226540	28/26,5	3,5	0,34	5/10
226542	30/28	3,5	0,4	5/10
226550	32/30,5	3,5	0,42	5/10

PERFORATED FLUTED TART MOULD

Fixed bottom. Homogeneous cooking.

Two-coat non-stick

GOBEL

Réf.	Ø	I	Ⓜ	> <
226321	20	2,5	0,17	5/10
226325	22	2,5	0,22	5/10
226331	24	2,5	0,25	5/10
226335	26	2,5	0,27	5/10
226341	28	2,5	0,31	5/10
226345	30	2,5	0,35	5/10
226351	32	2,5	0,39	5/10

DEEP PERFORATED FLUTED TART MOLD

Easy to unmold.

Two-coat non-stick

GOBEL

Réf.	Ø	I	Ⓜ	> <
226521	20	3,5	0,2	5/10
226531	24	3,5	0,27	5/10
226541	28,5	3,5	0,34	5/10

MEDIUM DEEP ROUND FLUTED TART MOULD - REMOVABLE BOTTOM

Easy and practical demoulding thanks to the removable bottom.

Two-coat non-stick

GOBEL

Réf.	Ø	I	Ⓜ	> <
226620	20/18,5	3,5	0,18	5/10
226622	22/20	3,5	0,26	5/10
226630	24/22,5	3,5	0,26	5/10
226632	26/24	3,5	0,33	5/10
226640	28/26,5	3,5	0,37	5/10
226642	30/28	3,5	0,43	5/10
226650	32/30,5	3,5	0,47	5/10

ROUND PERFORATED FLUTED TART MOULD - REMOVABLE BOTTOM

Easy and practical demoulding thanks to the removable bottom.

Two-coat non-stick

GOBEL

Réf.	Ø	I	Ⓜ	> <
226421	20	2,5	0,19	5/10
226425	22	2,5	0,22	5/10
226431	24	2,5	0,26	5/10
226435	26	2,5	0,3	5/10
226441	28	2,5	0,35	5/10
226445	30	2,5	0,38	5/10
226451	32	2,5	0,43	5/10

ROUND PLAIN TART MOULD

Easy to unmold.

 Two-coat non-stick



GOBEL

Réf.	∅	I	Ⓜ	> <
227310	12/10,5	2,5	0,08	5/10
227330	24/22,5	2,5	0,25	5/10
227340	28/26,5	2,5	0,34	5/10
227350	32/30,5	2,5	0,43	5/10

FRESHFRUIT FLUTED TART MOULD

Easy to unmold. Raised up in the center

 Two-coat non-stick



GOBEL

Réf.	∅	I	> <
226950	28	3,5	5/10

SET OF 6 NON-STICK FRESH FRUIT FLUTED TARTLET MOULD

Easy to unmold. Raised up in the center

 Two-coat non-stick



GOBEL

Réf.	∅	I	Ⓜ	> <
295790	10/8,4	1,8	0,31	5/10

DEEP ROUND PLAIN TART MOULD - REMOVABLE BOTTOM

Easy and practical demoulding thanks to the removable bottom.

 Two-coat non-stick



GOBEL

Réf.	∅	I	Ⓜ	> <
223801	10/9	3	0,07	5/10
223822	18/15,3	4,5	0,2	5/10

FRESHFRUIT FLUTED TARTLET MOULD

Easy to unmold. Raised up in the center

 Two-coat non-stick



GOBEL

Réf.	∅	I	Ⓜ	> <
295770	10/8,4	2	0,08	5/10

ROUND FLUTED TARTLET MOULD - REMOVABLE BOTTOM

Easy and practical demoulding thanks to the removable bottom.

 Two-coat non-stick



GOBEL

Réf.	∅	I	Ⓜ	> <
293470	10/8,5	1,8	0,05	5/10
293472	11/9	2	0,07	5/10
293480	12/11	2	0,08	5/10
293490	14/13	2,5	0,11	5/10

ROUND FLUTED TARTLET MOULD

Easy to unmold.

Two-coat non-stick

GOBEL

Réf.	∅	I	g	> <
293520	5/4	1	0,01	5/10
293530	6/5	1	0,02	5/10
293540	7/6	1	0,02	5/10
293550	8/7	1	0,03	5/10
293560	9/7,5	1,5	0,04	5/10
293570	10/8,5	2	0,04	5/10
293572	11/9	2	0,06	5/10
293580	12/11	2	0,07	5/10
293590	14/13	2,5	0,09	5/10

ROUND PLAIN TARTLET MOULD

Easy to unmold.

Two-coat non-stick

GOBEL

Réf.	∅	I	g	> <
293630	5/3	1,1	0,01	5/10
293640	6/3,8	1,2	0,02	5/10
293650	7/4,8	1,2	0,02	5/10
293660	8/5,8	1,5	0,03	5/10
293670	9/6,8	1,5	0,03	5/10
293680	10/7,8	1,5	0,04	5/10

SET OF 6 ROUND FLUTED TARTLET MOULD Ø100 MM

Easy to unmold.

Two-coat non-stick

GOBEL

Réf.	∅	I	g	> <
270171	10/8,5	1,8	0,26	5/10

SET OF 6 NON-STICK ROUND FLUTED TARTLET MOULD

Easy to unmold.

Two-coat non-stick

GOBEL

Réf.	∅	I	g	> <
282540	10/8,5	1,8	0,3	5/10

SET OF 6 ROUND FLUTED TARTLET MOULD Ø120 MM

Easy to unmold.

Two-coat non-stick

GOBEL

Réf.	∅	I	g	> <
282550	12/11	2	0,43	5/10

SET OF 12 ROUND FLUTED TARTLET MOULD Ø80 MM

Easy to unmold.

Two-coat non-stick

GOBEL

Réf.	∅	I	g	> <
282560	8/7	1,2	0,32	5/10

HALF TART MOULD FLUTED EDGES

Easy to unmold.

Two-coat non-stick



GOBEL



Ref.					
227840	28	2	0,2	Fluted edges	5/10

NON-STICK HALF TART MOULD

Easy to unmold.

Two-coat non-stick



GOBEL



Ref.					
227845	28	2	0,22	Plain edges	5/10

RECTANGULAR FLUTED TART MOULD

Easy to unmold.

Two-coat non-stick



GOBEL



Ref.					
225310	35/34	11/10	2,5	0,24	5/10

RECTANGULAR FLUTED TART MOULD - REMOVABLE BOTTOM

Easy and practical demoulding thanks to the movable bottom.

Two-coat non-stick



GOBEL



Ref.					
225410	35/34	11/10	2,5	0,26	5/10

PERFORATED OBLONG FLUTED TART MOULD - REMOVABLE BOTTOM

Easy and practical demoulding thanks to the removable bottom.

Two-coat non-stick



GOBEL



Ref.					
225412	35/34	11/10	2,5	0,25	5/10

RECTANGULAR FLUTED TART MOULD

Easy to unmold.

Two-coat non-stick



GOBEL



Ref.					
225710	29/27,5	20,5/19,5	2,5	0,46	5/10

RECTANGULAR FLUTED TART MOULD - REMOVABLE BOTTOM

Easy and practical demoulding thanks to the removable bottom.

Two-coat non-stick



GOBEL

Ref.					
225810	29/27,5	20,5/19,5	2,5	0,43	5/10

RECTANGULAR FLUTED TARTLET MOULD

Easy to unmold.

Two-coat non-stick



GOBEL

Ref.					
295130	12/11,2	7,5/6,6	2	0,06	5/10

RECTANGULAR FLUTED TARTLET MOULD - REMOVABLE BOTTOM

Easy and practical demoulding thanks to the removable bottom.

Two-coat non-stick



GOBEL

Ref.					
295330	12/11,2	7,5/6,6	2	0,07	5/10

SET OF 6 RECTANGULAR FLUTED TARTLET MOULD - REMOVABLE BOTTOM

Easy and practical demoulding thanks to the movable bottom.

Two-coat non-stick



GOBEL

Ref.						
291870	12/11,2	7,5/6,6	2	0,5	Loose bottom	5/10

SET OF 6 RECTANGULAR FLUTED TARTLET MOULD

Easy to unmold.

Two-coat non-stick



GOBEL

Ref.						
295376	12/11,2	7,5/6,6	2	0,4	Fixed bottom	5/10

NON-STICK SQUARE FLUTED TART MOULD

Easy to unmold.

Two-coat non-stick



GOBEL

Ref.					
226710	23/22	23/22	2,5	0,36	5/10

SQUARE FLUTED TART MOULD - REMOVABLE BOTTOM

Easy and practical demoulding thanks to the removable bottom.

Two-coat non-stick



GOBEL

Réf.					
226810	23/22	23/22	2,5	0,37	5/10

NON-STICK SQUARE FLUTED TARTLET MOULD

Easy to unmold.

Two-coat non-stick



GOBEL

Réf.					
294370	10/9	10/9	2	0,06	5/10

SQUARE FLUTED TARTLET MOULD - REMOVABLE BOTTOM

Easy and practical demoulding thanks to the removable bottom.

Two-coat non-stick



GOBEL

Réf.					
294470	10/9	10/9	2	0,07	5/10

SET OF 6 SQUARE FLUTED TARTLET MOULD

Easy to unmold.

Two-coat non-stick



GOBEL

Réf.						
294376	10/9	10/9	2	0,37	Fixed bottom	5/10

SET OF 6 SQUARE FLUTED TARTLET MOULD - REMOVABLE BOTTOM

Easy and practical demoulding thanks to the movable bottom.

Two-coat non-stick



GOBEL

Réf.						
294476	10/9	10/9	2	0,46	Loose bottom	5/10

SET OF 6 MILLASSON MOULD

Rolled edges. Easy to unmold.

Two-coat non-stick

GOBEL

Réf.	∅	I	📦	> <
282570	10/9	2,1	0,36	5/10

MILLASSON MOULD

Rolled edges. Easy to unmold.

Two-coat non-stick

GOBEL

Réf.	∅	I	📦	> <
293250	6/5	2	0,02	5/10
293270	8/6,8	2	0,04	5/10
293280	9/7,8	2	0,04	5/10
293290	10/9	2	0,06	5/10

ROUND PLAIN CAKE MOULD

Rolled edges. Ceramic reinforced two-layer non-stick. Easy to unmold.

Two-coat non-stick

GOBEL

Réf.	∅	I	📦	> <
223701	10/9	3	0,07	5/10
223702	12/10,5	3,4	0,09	5/10
223705	14/11,7	3,5	0,12	5/10
223710	16/13,6	4	0,15	5/10
223720	18/15,3	4,5	0,18	5/10
223730	20/17,5	4,5	0,23	5/10
223740	22/19,5	5	0,27	5/10
223750	24/10	5	0,29	5/10
223760	26/23,5	5	0,27	5/10
223770	28/25	5	0,39	5/10
223780	30/27,5	5,5	0,46	5/10
223790	32/29,5	5,5	0,51	5/10

ROSARY MOULD

Rolled edges. Easy to unmold.

Two-coat non-stick

GOBEL

Réf.	∅	I	📦	> <
222130	20/17,5	5	0,23	5/10

ROUND FLUTED CAKE MOULD - REMOVABLE BOTTOM

Narrow ribs. Easy and practical demoulding thanks to the removable bottom.

Two-coat non-stick



GOBEL

Réf.	∅	I	Ⓜ	> <
224810	10/8	3	0,07	5/10
224820	15/13	4	0,14	5/10

PERFORATED TART PAN - REMOVABLE BOTTOM

Perfect for custard pies and quiches. Perforated loose bottom: allows draining away moisture excess in preparations with cream and water (vegetables) for a well-cooked pie crust. Easy release. Straight rolled edge.

Two-coat non-stick

BEST SELLER



GOBEL



Réf.	∅	I	Ⓜ	> <
252660	27	4,5	0,44	5/10

SPRINGFORM CAKE PAN

1 bottom. Easy and practical demoulding thanks to the hinge.

Non-stick coated steel

BEST SELLER



Réf.	∅	I	Ⓜ	> <
221640	22	7	0,27	3/10
221650	24	7	0,32	3/10
221660	26	7	0,35	3/10
221670	28	7	0,35	3/10
221680	30	7	0,38	3/10

DETACHABLE DEEP MOULD - 2 BOTTOMS

2 bottoms : 1 flat + 1 fluted with tube. Easy demoulding thanks to the hinge.

Two-coat non-stick



GOBEL



Réf.	∅	I	Ⓜ	> <
221750	24	7	0,39	3/10
221770	28	7	0,35	3/10

SQUARE CAKE MOULD

Reinforced rolled edges. Easy to unmold.

Two-coat non-stick

BEST SELLER



GOBEL



Réf.	∏	∏	I	Ⓜ	> <
224101	10/9	10/9	4	0,13	5/10
224110	22/20,5	22/20,5	5	0,43	5/10
224120	24/22,5	24/22,5	5	0,6	5/10

SQUARE CAKE MOULD - REMOVABLE BOTTOM

Reinforced rolled edges. Easy unmoulding thanks to the mobile bottom.

Two-coat non-stick

BEST SELLER



GOBEL



Réf.	∏	∏	I	Ⓜ	> <
224210	22/20,5	22/20,5	5	0,52	5/10
224220	24/22,5	24/22,5	5	0,6	5/10

BAKING SHEET

Reinforced rolled edges. Easy to unmold.

Two-coat non-stick

GOBEL

Ref.						
225100	30/30,8	20/20,8	3,5	0,46		5/10
225101	35/35,8	25/25,8	5	0,65		5/10
225105	35/35,8	25/25,8	3,5	0,6		5/10
225110	40/41,4	30/31,4	3,5	1,03		5/10
225120	51/52,4	36/37,5	5	1,52		5/10
255610	40/41,4	30/31,4	5	1,1		5/10

NON-STICK

SAVARIN OR RING MOULD

Open tude - stamped

Two-coat non-stick



GOBEL

Réf.	∅	I	W	> <
224040	22	4,5	0,26	5/10
224050	24	5	0,3	5/10

TROIS FRERES - TWISTED SAVARIN OR RING MOULD

Open cylinder. Stamped. Twisted savarin, crown shape. Ideal for rum baba and king cake.

Two-coat non-stick



GOBEL

Réf.	∅	I	W	> <
224340	22	5,5	0,36	5/10

DEEP SAVARIN OR RING MOULD

Open tude - stamped. Easy to unmold.

Two-coat non-stick



GOBEL

Réf.	∅	I	W	> <
254050	24	5,8	0,35	5/10
254060	26	6	0,41	5/10

SINGLE SERVING SAVARIN MOULD - CLOSED CYLINDER

Closed cylinder. Savarin, crown shape. Ideal for rum baba and king cake.

Two-coat non-stick



GOBEL

Réf.	∅	I	W	> <
223930	8	2	0,04	5/10

SINGLE SERVING SAVARIN MOULD - OPEN CYLINDER

Open cylinder. Savarin, crown shape. Ideal for rum baba and king cake.

Two-coat non-stick



GOBEL

Réf.	∅	I	W	> <
224030	8	2	0,04	5/10
224034	12	2,5	0,09	5/10

BOX SET OF 6 SINGLE SERVING SAVARIN MOULDS

6 individual savarins, crown shape. Closed cylinder.

Two-coat non-stick



GOBEL

Réf.	∅	I	W	W	> <
272710	17,3	3,7	8,5	0,25	5/10

SOUFFLE MOULD

Two-coat non-stick



GOBEL

Ref.				
210920	18	10	0,85	5/10

SINGLE SERVING SOUFFLE MOULD

Homogeneous cooking. Easy to unmold.

Two-coat non-stick



GOBEL

Ref.				
235110	8	5	0,06	5/10

BOX OF 4 SINGLE SERVING SOUFFLE MOULDS

Two-coat non-stick



GOBEL

Ref.				
282520	8	5	0,28	5/10

CHARLOTTE MOULD

Stamped.

Two-coat non-stick



GOBEL



Ref.				
212620	18/15	10	0,3	5/10

VALENTINE'S DAY HEART-SHAPED MOULD

Fixed bottom, rolled edges. Easy to unmold.

Two-coat non-stick



GOBEL

Ref.					
255130	16	15	3,5	0,17	5/10

VALENTINE'S DAY HEART-SHAPED MOULD - REMOVABLE BOTTOM

Loose bottom, rolled edges. Easy to unmold.

Two-coat non-stick



GOBEL

Ref.					
255230	16	15	3,5	0,2	5/10



DIPLOMATE OR BAVAROIS MOULD

For dessert and jellies. Stamped.

 Two-coat non-stick

GOBEL



Réf.				
224610	18/15	9	0,26	5/10

KOUGLOF MOULD

Easy to unmold.

 Two-coat non-stick

GOBEL



Réf.				
228020	21	8	0,17	5/10

TRADITIONAL FRENCH CHEESECAKE MOULD

Easy to unmold.

 Two-coat non-stick

GOBEL



Réf.				
251210	14/7	4	0,11	5/10





FRIAND MOULD

For puff pastries based on cheese, meat, vegetables...

 Two-coat non-stick

GOBEL



Réf.					
293030	9,8/8,3	5,1/3,1	1,4	0,03	5/10

BOX OF 60 PETITS-FOURS MOULDS

5 x 12 assorted models

Two-coat non-stick



GOBEL

Ref.					
285201	12	4	0,47	5/10	

PETITS-FOURS MOULDS

Easy to unmold.

Two-coat non-stick



GOBEL

Ref.								
291010	6		1			0,01	Plain diamond	5/10
291510	6		1			0,01	Diamond-shaped boat	5/10
292010				5	1	0,01	Plain rectangle	5/10
292510				3,5		0,01	Deep plain round	5/10
293510				4,5	1	0,01	Fluted round	5/10
293610				3,5	1	0,01	Round plain tartlet mould	5/10
293620				4	1	0,01	Round plain tartlet mould	5/10
294020	7	2,8	1			0,01	Plain boat-shaped mould	5/10
295010		3,5	3,5	1		0,01	Fluted square	5/10
295510				4,5	1	0,01	Ribbed dome	5/10
296010				4,5	1	0,01	Fluted oval	5/10
296510				4,5	1	0,01	Ribbed oval	5/10

BOX OF 30 PETITS-FOURS MOULDS

6 x 5 assorted models: fluted round + fluted square + diamond-shaped boat + plain round + plain diamond

Two-coat non-stick



GOBEL



Ref.					
285400		12	3	0,24	5/10

BOAT SHAPED MOULD

Easy to unmold.

Two-coat non-stick



GOBEL



Ref.						
294010	6	2	1	0,01	5/10	
294030	8	3,3	1,2	0,01	5/10	
294040	9	4	1,2	0,01	5/10	
294050	10	4,3	1,3	0,02	5/10	
294060	11	4,6	1,3	0,02	5/10	
294070		12	5	1,3	0,02	5/10

FLUTED BOAT SHAPED MOULD

Easy to unmold.

Two-coat non-stick



GOBEL

Réf.					
294110	8	4	1,2	0,02	5/10
294120	9	4,3	1,2	0,02	5/10
294130	10	4,5	1,2	0,02	5/10
294140	11	4,7	1,3	0,02	5/10
294150	12	5	1,4	0,03	5/10

OVAL STAR BOTTOM ASPIC MOULD

Easy to unmold.

Two-coat non-stick



GOBEL

Réf.					
230310	7,5	5,5	3,8	0,04	5/10

OVAL PLAIN BOTTOM ASPIC MOULD

Easy to unmold.

Two-coat non-stick



GOBEL

Réf.					
230210	7,5	5,5	3,8	0,04	5/10

SET OF 4 BOAT-SHAPED MOULDS

Easy to unmold.

Two-coat non-stick



GOBEL

Réf.					
271011	7,5	5,5	3,8	0,17	5/10

MUFFIN MOULD

Easy to unmold.

Two-coat non-stick



GOBEL

Réf.				
296511	7	3,5	0,02	5/10

BOX OF 6 MUFFIN MOULDS

Easy to unmold.

Two-coat non-stick



GOBEL

Réf.					
296512	7,5	7,5	4	0,14	5/10

The dimensions are expressed in cm, the weight in kg.
www.louistellier.fr

RUM BABA MOULD

Stamped, rolled edges. Easy to unmold.

Two-coat non-stick

BEST SELLER



GOBEL

Réf.				
229810	6/4,8	6	0,05	5/10

CANELE BORDELAIS MOULD

Authentic taste of canelés: nicely caramelized on the outside, soft on the inside. Optimal thermal conductivity of aluminium. Non-stick coating for easy unmoulding. Long-lasting four-layer non-stick coating.

Non-stick coated aluminium

BEST SELLER



GOBEL

Réf.					
729510	3,5	3,5	0,01	S	10/10
729520	4,5	4,3	0,02	M	10/10
729530	5,5	5	0,02	L	10/10

BOX OF 6 CANELE BORDELAIS MOULDS

A tasty result : beautiful caramelization on the outside and a soft interior. Optimal heat conduction of aluminium. Easy to unmold. Longevity of the 4-layer non-stick coating.

Mould size : 55 x 50 mm.

Non-stick coated aluminium



GOBEL



Réf.					
729540	13	8,5	7	0,14	10/10

RUM BABA RECIPE PACK

Ideal for animating and energizing the shelf background. For highlighting product, thematic. Present box.

 Two-coat non-stick



GOBEL

Réf.					
224050-PK	24	5	0,3	Master of 6 boxes. For Savarin Ref. 224050 Ø24.	224050

LEMON PIE RECIPE PACK

Ideal for animating and energizing the shelf background. For highlighting product, thematic. Present box.

 Two-coat non-stick



GOBEL

Réf.					
226340-PK	28/27	2,8	0,33	Master of 6 boxes. For fluted round tart mould Ref. 226340 Ø28.	226340

TARTE TATIN RECIPE PACK

Ideal for animating and stimulate the business store. For product highlighting, thematic. Present box.

 Two-coat non-stick



GOBEL

Réf.					
223760-PK	26/23,5	5	0,27	Master of 6 boxes. For round plain cake mould Ref. 223760 Ø 26.	223760



LORRAINE QUICHE RECIPE PACK

Ideal for animating and energizing the shelf background. For highlighting product, thematic. Present box.

 Two-coat non-stick



GOBEL

Réf.					
226120-PK	26/23	3	0,3	Master of 6 boxes. For round flat edge fluted pie dish Ref. 226120 Ø26.	226120

1001 TART KIT

Contains : 1 round fluted tart mold Ø 28 cm, 6 round fluted tart molds Ø 10 cm, 1 La Bonne Graine brand apple peeler for peeling, slicing and coring apples quickly and recipe ideas.

 1 tart mold : two-coat non-stick / 6 tartlets : two-coat non-stick / 1 apple peeler : stainless steel and epoxy painted cast steel support



GOBEL

Réf.				
GL20P011	30	30	14,5	1,21

MULTI BAKING TRAYS



Easy handling:
time saving

Sturdy: designed
for intensive use

Non-stick
coated steel



Suitable for **professional ovens**
and **pastry ladders:**
can be used without a rack

Optimal heat conduction:
shorter cooking time
and **energy savings**

■ Professional plate incorporating 18 molds for all your sweet and savory preparations.

NON-STICK

CANELE BORDELAIS MOULD

Cavities : Ø 55 mm H 50 mm. Suitable for ovens and pastry ladders : can be used without grid. For intensive use.

Non-stick coated steel



GOBEL

Réf.					
299130	60	40	3,5	45 imprints. Delivery time : 5 weeks.	5/10

DEEP CAKE PAN

Cavities : Ø 100 mm H 30 mm. Suitable for ovens and pastry ladders : can be used without grid. For intensive use.

Non-stick coated steel



GOBEL

Réf.						
299101	60	40	3,5	2,38 14 imprints. Delivery time : 5 weeks.	5/10	

MILLASSON MOULDS

Suitable for ovens and pastry scales : can be used without a grid. For intensive use.

Non-stick coated steel



GOBEL

Réf.					
299102	60	40	3,5	18 imprints Ø90 H19 mm. Delivery time : 5 weeks.	5/10
299103	60	40	3,5	25 imprints Ø80 H18 mm. Delivery time : 5 weeks.	5/10

RUM BABA MOULDS

Cavities : Ø 60 mm H 60 mm. Suitable for ovens and pastry ladders : can be used without grid. For intensive use.

Non-stick coated steel



GOBEL

Réf.					
299105	60	40	3,5	35 imprints . Delivery time : 5 weeks.	5/10

MADELEINES MOULDS

Suitable for ovens and pastry scales : can be used without a grid. For intensive use.

Non-stick coated steel



GOBEL

Réf.						
299108	60	40	3	1,9 36 imprints Madeleines. Delivery time : 5 weeks.	5/10	

SMALL MADELEINES MOULDS

Suitable for ovens and pastry scales : can be used without a grid. For intensive use.

Non-stick coated steel



GOBEL

Réf.					
299109	60	40	3,5	100 imprints Madeinettes. Delivery time : 5 weeks.	5/10

NON-STICK

FINANCIER MOULD

24 financier moulds : 98 x 48 H 13 mm. Suitable for ovens and pastry ladders : can be used without grid. For intensive use.

Non-stick coated steel



GOBEL

Réf.				> <
299110	60 40 3	2,17	Delivery time : 5 weeks	5/10

MUFFIN MOULD

Cavities : Ø 70 mm H 35 mm. Suitable for ovens and pastry ladders : can be used without grid. For intensive use.

Non-stick coated steel



GOBEL

Réf.				> <
299104	60 40 3,5	33 imprints.	Delivery time : 5 weeks.	5/10

CLOSED SAVARIN MOULD

Cavities : Ø 80 mm H 20 mm. Suitable for ovens and pastry ladders : can be used without grid. For intensive use.

Non-stick coated steel



GOBEL

Réf.				> <
299106	60 40 3,5	2,34	25 imprints. Delivery time : 5 weeks.	5/10

OVAL MOULD

32 cavities : H 38 mm. Suitable for ovens and pastry ladders : can be used without grid. For intensive use.

Non-stick coated steel



GOBEL

Réf.				> <
299107	60 40 3,5	Delivery time : 5 weeks		5/10

DEEP CAKE PAN

8 cavities : Ø 100 mm H 30 mm

Non-stick coated steel



GOBEL

Réf.				> <
299201	53 32,5 3,5	8 imprints.	Delivery time : 5 weeks.	5/10

MILLASSON MOULD

Suitable for ovens and pastry scales : can be used without a grid. For intensive use.

Non-stick coated steel



GOBEL

Réf.				> <
299202	53 32,5 3,5	15 imprints Ø80 H18 mm.	Delivery time : 5 weeks.	5/10
299203	53 32,5 3,5	24 cavities Ø90 H19 mm.	Delivery time : 5 weeks.	5/10

RUM BABA MOULD

Cavities : Ø 60 mm H 60 mm. Suitable for ovens and pastry ladders : can be used without grid. For intensive use.

Non-stick coated steel



GOBEL

Réf.					
299205	53	32,5	3,5	24 imprints. Delivery time : 5 weeks.	5/10

CANELE BORDELAIS MOULD

Cavities : Ø 55 mm H 50 mm. Suitable for ovens and pastry ladders : can be used without grid. For intensive use.

Non-stick coated steel



GOBEL

Réf.					
299230	53	32,5	3,5	32 cavities. Delivery time : 5 weeks.	5/10

MUFFIN MOULD

Cavities : Ø 70 mm H 35 mm. Suitable for ovens and pastry ladders : can be used without grid. For intensive use.

Non-stick coated steel



GOBEL

Réf.					
299204	53	32,5	3,5	15 cavities. Delivery time : 5 weeks.	5/10

CLOSED SAVARIN MOULD

Cavities : Ø 80 mm H 20 mm. Suitable for ovens and pastry ladders : can be used without grid. For intensive use.

Non-stick coated steel



GOBEL

Réf.					
299206	53	32,5	3,5	15 imprints. Delivery time : 5 weeks	5/10

BUNS MOULD

8 cavities : Ø 100 mm H 20 mm.
Non contractual photo.

Non-stick coated steel



GOBEL

Réf.					
299220	53	32,5	3,5	8 imprints. Delivery time : 5 weeks.	5/10



OBSIDIAN NON-STICK



**OBSIDIAN BAKING SHEETS AND
MOULDS**

215



OBSIDIAN

THE NON-STICK COOKWARE 10-YEARS WARRANTY

«DURABILITY»

New «two-layer» ceramic reinforced coating with 20% more thickness

EXTREME RESISTANCE OVER TIME

- 10 year warranty
- For a sustained frequency of use and exceptional non-stick properties

EASY AND FAST DEMOULDING

- Fat free, perfect release
- Non-stick coating, guaranteed without PFOA, professional quality
- Compliance with REACH standards

CONTROL OF CARAMELIZATION

- For precision coloring
- Tough against sugar and jam



CHEF'S NOTE

Ideal for pastry making, this non-stick is also suitable for savoury recipes!

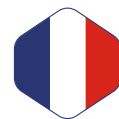

Made in France



MAINTENANCE

- Clean before 1st use
- Preferably wash by hand
- Wash with soapy water



Always attentive to innovations and technical progress, Gobel exclusively offers the OBSIDIAN range, the latest in coating technology, suitable for normal to intensive use.

The OBSIDIAN GOBEL non-stick range, guaranteed for 10 years, is made of very high quality coated steel whose thickness is increased by 20% compared to our historical steel plates (i.e. 0.6 mm), for even more robustness.

6 XXL MADELEINES BAKING SHEET

For XXL madeleines. Rolled edge. Cavity : 106 x 66 mm.
20% thicker material for rugged strength and durability. 20% more non-stick for perfect caramelization control.

Obsidian non-stick



GOBEL

Réf.					
464810	39,5	22,7	2	0,47	6/10

12 MADELEINES BAKING SHEET

Rolled edge. Cavity : 80 mm.
20% thicker material for rugged strength and durability. 20% more non-stick for perfect caramelization control.

Obsidian non-stick



GOBEL

Réf.					
464710	39,5	20	1,7	0,47	6/10

20 SMALL MADELEINES BAKING SHEET

Rolled edge. Cavity : 42 mm.
20% thicker material for rugged strength and durability. 20% more non-stick for perfect caramelization control.

Obsidian non-stick



GOBEL

Réf.					
464510	39,5	12,5	1,3	0,27	6/10

6 FINANCIER BAKING SHEET

Rolled edge.
20% thicker material for rugged strength and durability. 20% more non-stick for perfect caramelization control.

Obsidian non-stick



GOBEL

Réf.			
420710	38	18	6/10

2 FRENCH BAGUETTE BAKING PAN

20% thicker material for rugged strength and durability. 20% more non-stick for perfect caramelization control.

Obsidian non-stick



GOBEL

Réf.					
458320	38	16,2	2	0,37	6/10

PERFORATED 2 FRENCH BAGUETTE BAKING PAN

20% thicker material for rugged strength and durability. 20% more non-stick for perfect caramelization control.

Obsidian non-stick



GOBEL

Réf.					
458321	37,7	16	2	0,36	6/10

ROUND CAKE MOULD OBSIDIAN



For **frequent** use

20% thicker steel = sturdier and more durable



Perfect mastery of caramelization, supports more sugar and jam



New two-layer **PFA**-based coating, **the excellence of non-stick.** For an easy and quick release, without adding fat

★★★★
EXCELLENT
Anti-adhérent / Non-stick effect

DOUBLE COUCHES / COATING BASE PFA | **RENFORT CÉRAMIQUE** REINFORCED CERAMIC

Ideal for baking, Obsidian moulds are perfect for savoury recipes. The Obsidian range is composed of 26 different references including 3 sizes of Round cake moulds, from family size to individual size.
*Under conditions of normal use and maintenance.

STAMPED CAKE

20% thicker material for rugged strength and durability. 20% more non-stick for perfect caramelization control.

Obsidian non-stick



GOBEL

Réf.	↔	↗	⊥	📦	🔍	> <
423320	26/23	9,5/6,5	7,5	0,32	Stamped - Rolled edges	6/10

ROUND FLUTED TART MOULD

20% thicker material for rugged strength and durability. 20% more non-stick for perfect caramelization control.

Obsidian non-stick



GOBEL

Réf.	∅	⊥	📦	🔍	> <
426320	20	3	0,2	Fixed bottom	6/10
426330	24	3	0,3	Fixed bottom	6/10
426340	28	3	0,4	Fixed bottom	6/10
426350	32	3	0,5	Fixed bottom	6/10

BOX OF 6 ROUND FLUTED TARTLET MOULDS

20% thicker material for rugged strength and durability. 20% more non-stick for perfect caramelization control.

Obsidian non-stick



GOBEL

Réf.	∅	⊥	📦	🔍	> <
470171	10/8,5	1,8	0,05	Fixed bottom	6/10

ROUND FLUTED TART MOULD - REMOVABLE BOTTOM

20% thicker material for rugged strength and durability. 20% more non-stick for perfect caramelization control.

Obsidian non-stick

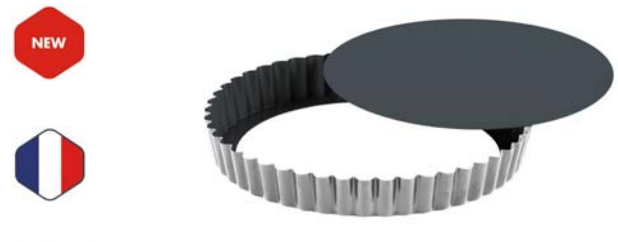

GOBEL

Réf.	∅	⊥	📦	🔍	> <
426440	28/27	3	0,42	Loose bottom	6/10

RECTANGULAR FLUTED TART MOULD - REMOVABLE BOTTOM

20% thicker material for rugged strength and durability. 20% more non-stick for perfect caramelization control.

Obsidian non-stick



GOBEL

Réf.	↔	↗	⊥	📦	🔍	> <
425410	35/34	11/10	2,5	0,32	Fluted. Loose bottom.	6/10

SQUARE TART MOULD - REMOVABLE BOTTOM

20% thicker material for rugged strength and durability. 20% more non-stick for perfect caramelization control.

Obsidian non-stick



GOBEL

Réf.	↔	↗	⊥	📦	🔍	> <
426810	23/22	23/22	2,5	0,47	fluted	6/10

FLUTED PERFORATED TART MOULD - REMOVABLE BOTTOM

20% thicker material for rugged strength and durability. 20% more non-stick for perfect caramelization control.

Obsidian non-stick



GOBEL

Réf.	Ø	I	Weight	Quantity
426431	24	2,5	0,31	6/10
426441	28	2,8	0,41	6/10
426451	32	2,8	0,52	6/10

ROUND PLAIN CAKE MOULD

20% thicker material for rugged strength and durability. 20% more non-stick for perfect caramelization control.

Obsidian non-stick



GOBEL

Réf.	Ø	I	Weight	Quantity
423730	20/17,5	5	0,27	6/10
423750	24/10	5	0,37	6/10
423760	26/23,5	5	0,43	6/10

SAVARIN OR RING MOULD

20% thicker material for rugged strength and durability. 20% more non-stick for perfect caramelization control.

Obsidian non-stick



GOBEL

Réf.	Ø	I	Weight	Material	Quantity
454050	24	5	0,43	Open tude - stamped	6/10

BOX SET OF 6 MUFFIN MOULDS

20% thicker material for rugged strength and durability. 20% more non-stick for perfect caramelization control.

Obsidian non-stick



GOBEL

Réf.	Ø	I	Weight	Quantity
496512	7	3,5	0,02	6/10

BRIOCHE PAN

20% thicker material for rugged strength and durability. 20% more non-stick for perfect caramelization control.

Obsidian non-stick



GOBEL

Réf.	Ø	I	Weight	Quantity
423040	20,5	9	0,29	6/10

BOX OF 6 CONTINENTAL STYLE BRIOCHE MOULD

20% thicker material for rugged strength and durability. 20% more non-stick for perfect caramelization control.

Obsidian non-stick



GOBEL

Réf.	Ø	I	Weight	Material	Quantity
493740	8/4	3,2	0,05	Flat bottom	6/10

OBSIDIAN CHARLOTTE MOULD

20% thicker material for rugged strength and durability. 20% more non-stick for perfect caramelization control.

 Obsidian non-stick



GOBEL

Ref.					
412620	18,15	10	0,36	Stamped	6/10



TIN

BAKING/BREAD/PIZZA TRAYS	223
FOLDING LOAF CAKE MOULDS	226
CAKE MOULDS	227
BRIOCHE MOULDS	228
ROUND PLAIN TART MOULDS	231
ROUND CAKES AND MILLASSON MOULDS	235
BAKING SHEET AND THEME MOULDS	237
INDIVIDUAL BITES & CAKES	239

ORIGINE

BIODEGRADABLE ORIGINE MOULDS	243
-------------------------------------	------------

FRANCE 1887
GOBEL®

rien ne remplace le fait main

TIN

«THE AUTHENTICITY»

HEALTHIEST MATERIAL

- Tinplate is a natural, durable and 100% recyclable material!

EXCELLENT HEAT CONDUCTOR

- Perfect and homogeneous cooking
- Fast heat up

IDEAL CARAMELIZATION

- Crispy on the outside and soft on the inside!
- The contact of the mould favors the caramelization of the sugar



CHEF'S NOTE

For an impeccable unmoulding, grease the pan with butter, flour or a release spray!

MAINTENANCE

- Dry well after cleaning
- Do not put in the dishwasher
- Avoid abrasive sponges

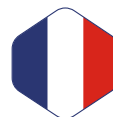

Made in France



MADELEINES BAKING SHEET - 6 XXL CAVITIES

For XXL madeleines. Rolled edge. Cavity : 106 x 66 mm.

Tinplate



GOBEL

Ref.					
164810	39,6	22,7	2	0,4	5/10

12 MADELEINES BAKING SHEET

Cavities : 8 mm each - rolled edges

Tinplate



GOBEL

Ref.					
164710	39,5	20	1,7	0,4	5/10

20 SMALL MADELEINES BAKING SHEET

Cavities : 42 mm each. Rolled edge.

Tinplate



GOBEL

Ref.					
164510	39,5	12,5	1,3	0,23	5/10

6 FINANCIERS BAKING SHEET

Stamped. 6 cavities : 98 x 48 mm each

Tinplate



GOBEL

Ref.					
120710	38	18	1,3	0,31	5/10

MINI-FINANCIERS OR BISCUITS ROSE DE REIMS BAKING SHEET

Stamped. 2 rows of 6 cavities of 75 mm each

Tinplate



GOBEL

Ref.					
167030	29	19,8	1,7	0,31	5/10

DENT DE LOUP MOULD

Count 20 cookies per tray.

Tinplate



GOBEL

Ref.					
120510	30	29	2,5	0,62	5/10

THE GOBEL MADELEINES BAKING SHEET



Makes madeleines perfectly golden

Rolled edge

Tin plate, a recyclable material



Free from bisphenol A and perfluoro-octanoic acid



Cavities that allow the dough to be cooked evenly

Since 1887, GOBEL has placed at your service all its experience and know-how in manufacturing tin-plate moulds. Today, it is one of the last mould-making workshops that continues to crimp its moulds in this eco-material that offers exceptional thermal conductivity!

Guarantors of an unequalled tasting result, the moulds are reputed for making dough crunchy: golden on the outside and soft on the inside, your pastry creations are thus refined.

SWISS ROLL TIN

Stamped. Raised edges reinforced with wire.

Tinplate



GOBEL

Réf.	↔	↗	⊥	📦	🔍	> <
121020	40	30	1,6	0,61	Delivery time : 5 weeks	5/10
121010	37	27	1,6	0,53	Delivery time : 5 weeks	5/10

PERFORATED BREAD PAN

Perforations promote hot air circulation and allow excess moisture to escape for even cooking.

Tinplate



GOBEL

Réf.	↔	↗	⊥	📦	> <
123690	27/25	10,5/8	8	0,35	5/10
134000	16/14	10/8	7	0,22	5/10

RECTANGULAR BREAD MOULD

Perforations promote hot air circulation and allow excess moisture to escape for even cooking.

Tinplate



GOBEL

Réf.	↔	↗	⊥	📦	> <
134010	24/22	12/10	7	0,34	5/10

ROUND BREAD MOULD

Perforations promote hot air circulation and allow excess moisture to escape for even cooking.

Tinplate



GOBEL

Réf.	∅	⊥	📦	> <
135010	23/20	6	0,31	5/10

PIZZA PAN

In tinplate, a better heat conductor than stainless steel.

Tinplate



GOBEL

Réf.	∅	⊥	📦	> <
127010	24/23	1,3	0,24	5/10
127020	30/29	1,3	0,35	5/10
127030	34/33	1,3	0,42	5/10

PERFORATED PIZZA PAN WITH BASE

In tinplate, a better heat conductor than stainless steel.

Tinplate



GOBEL

Réf.	∅	⊥	📦	> <
127120	30/29	1,5	0,34	5/10
127130	34/33	1,5	0,42	5/10

LONG PLAIN LOAF PAN (MINI)

Easy and practical unmoulding thanks to the hinge and the removable bottom.

Tinplate

GOBEL

Ref.					
119410	30	4	6	0,37	5/10
119440	50	4	6	0,58	5/10

LONG PLAIN LOAF PAN

Easy and practical unmoulding thanks to the hinge and the removable bottom.

Tinplate

GOBEL

Ref.					
119710	30	8	8	0,53	5/10
119720	35	8	8	0,6	5/10
119730	40	8	8	0,67	5/10
119740	50	8	8	0,8	5/10

FOLDING LOAF PAN OR CAKE MOULD

Easy and practical demoulding.

Tinplate

GOBEL

Ref.					
120010	24/22	9,5/8	7	0,35	5/10
120020	27/25	10/9	7,5	0,42	5/10
120030	30/28,5	10/9	7,5	0,46	5/10

STAMPED CAKE

Tinplate



GOBEL



Ref.					
123330	28/25	10/7,5	7,5	0,35	5/10
123320	26/23	9,5/6,5	7,5	0,28	5/10

REINFORCED EDGE WITH WIRE CAKE MOULD

Tinplate



GOBEL



Ref.					
123610	15/13	7/5	5,5	0,16	5/10
123620	18/15,7	8/5,7	6,5	0,2	5/10
123630	21/18,5	9/6,5	7	0,26	5/10
123640	24/21,5	9/6,5	7	0,3	5/10
123650	27/24,2	10,5/7,7	8	0,36	5/10
123660	30/27,2	10,5/7,7	8	0,4	5/10
123670	33/30,2	10,5/7,7	8	0,43	5/10
123680	36/33,2	10,5/7,7	8	0,46	5/10

BRIOCHE - 9 RIBS

Flat bottom.

Tinplate

GOBEL

Ref.				
193710	6/2,8	2,5	0,02	5/10
193720	7/3,7	2,8	0,03	5/10

BRIOCHE WITH FLAT BOTTOM - 10 RIBS

Flat bottom.

Tinplate

GOBEL

Ref.				
193730	7,5/4	3	0,03	5/10
193740	8/4	3,5	0,04	5/10
193750	9/4,5	3,5	0,04	5/10
193760	10/5,5	4	0,05	5/10
193770	11/5,5	3,5	0,06	5/10

BRIOCHE MOULD - WIDE RIBS

Flat bottom.

Tinplate

GOBEL

Ref.				
123010	14/7,3	6	0,12	5/10
123020	16/8,3	5,5	0,15	5/10
123030	18/19,1	5,6	0,18	5/10
123040	20/9,7	7,2	0,24	5/10
123050	22/9,9	9	0,3	5/10



PERFORATED FLUTED TART MOULD



Removable bottom: easy to remove from the mould **100% of success**

Tinplate: a **recyclable material**



Exceptional thermal conductivity

Perforated bottom: even heat distribution, perfect for thick preparations

Since 1887, GOBEL has put all its experience and historical know-how at your service in the manufacture of tinplate moulds. Today one of the last moulding workshops in France to stamp its moulds in this ecological material which offers exceptional thermal conductivity.

ROUND FLUTED TART MOULD

Tinplate



GOBEL



Réf.	∅	I	📦	> <
126320	20/18,5	2,8	0,17	5/10
126322	22/20	2,5	0,22	5/10
126330	24/23	2,8	0,25	5/10
126332	26/24	2,8	0,29	5/10
126340	28/27	2,5	0,32	5/10
126342	30/28	2,5	0,37	5/10
126350	32/31	2,5	0,42	5/10

ROUND FLUTED TART MOULD - REMOVABLE BOTTOM

Easy and practical demoulding thanks to the removable bottom.

Tinplate



GOBEL



Réf.	∅	I	📦	> <
126420	20/18,5	2,8	0,19	5/10
126422	22/20	2,5	0,22	5/10
126430	24/23	3	0,26	5/10
126432	26/24	2,5	0,3	5/10
126440	28/27	2,5	0,35	5/10
126442	30/28	2,5	0,38	5/10
126450	32/31	2,8	0,43	5/10

DEEP ROUND FLUTED TART MOULD

Tinplate



GOBEL



Réf.	∅	I	📦	> <
126520	20/18,5	3,5	0,2	5/10
126522	22/20	3,5	0,24	5/10
126530	24/22,5	3,5	0,27	5/10
126532	26/24	3,5	0,31	5/10
126540	28/26,5	3,5	0,34	5/10
126542	30/28	3,5	0,4	5/10
126550	32/30,5	3,5	0,42	5/10

PERFORATED FLUTED TART MOULD

Perforations promote hot air circulation and allow excess moisture to escape for even cooking.

Tinplate



GOBEL



Réf.	∅	I	📦	> <
126321	20	2,5	0,17	5/10
126325	22	2,5	0,22	5/10
126331	24	2,5	0,25	5/10
126335	26	2,5	0,3	5/10
126341	28	2,5	0,31	5/10
126345	30	2,5	0,35	5/10
126351	32	2,5	0,39	5/10

MEDIUM DEEP ROUND FLUTED TART MOULD - REMOVABLE BOTTOM

Easy and practical demoulding thanks to the removable bottom.

Tinplate



GOBEL



Réf.	∅	I	📦	> <
126620	20/18,5	3,5	0,22	5/10
126622	22/20	3,5	0,26	5/10
126630	24/22,5	3,5	0,29	5/10
126632	26/24	3,5	0,33	5/10
126640	28/26,5	3,5	0,37	5/10
126642	30/28	3,5	0,43	5/10
126650	32/30,5	3,5	0,4	5/10

PERFORATED FLUTED TART MOULD - REMOVABLE BOTTOM

Easy unmoulding thanks to the mobile bottom. Perforations promote hot air circulation and allow excess moisture to escape for even cooking.

Tinplate



GOBEL



Réf.	∅	I	📦	> <
126421	20	2,5	0,18	5/10
126425	22	2,5	0,22	5/10
126431	24	2,5	0,26	5/10
126435	26	2,8	0,29	5/10
126441	28	2,5	0,35	5/10
126445	30	2,5	0,38	5/10
126451	32	2,5	0,43	5/10

ROUND FLUTED TARTLET MOULD

Tinplate



GOBEL



Réf.	∅	I	📦	> <
193520	5/4	1	0,01	5/10
193530	6/5	1	0,02	5/10
193540	7/6	1	0,02	5/10
193550	8/7	1	0,03	5/10
193560	9/7,5	1,5	0,04	5/10
193570	10/8,5	2	0,04	5/10
193572	11/9	2	0,05	5/10
193580	12/11	2	0,06	5/10
193590	14/13	3	0,09	5/10

ROUND FLUTED TARTLET MOULD - REMOVABLE BOTTOM

Easy and practical demoulding thanks to the removable bottom.

Tinplate



GOBEL



Réf.	∅	I	📦	> <
193470	10/8,5	2	0,05	5/10
193472	11/9	2	0,07	5/10
193480	12/11	2	0,08	5/10
193490	14/13	2,5	0,11	5/10

ROUND PLAIN TARTLET MOULD

Tinplate



GOBEL

Réf.	∅	I	📦	> <
193630	5/3	1,1	0,01	5/10
193640	6/3,8	1,5	0,02	5/10
193650	7/4,8	1,2	0,02	5/10
193660	8/5,8	1,5	0,02	5/10
193670	9/6,8	1,5	0,03	5/10
193680	10/7,8	1,5	0,04	5/10

TART RING

Tin being a better conductor, these tart rings ensure a golden and crusty dough.

Tinplate



GOBEL

Réf.	∅	I	📦	> <
124940	10	2	0,03	4/10
124950	20	2	0,08	4/10
124990	28	2	0,12	4/10

RECTANGULAR FLUTED TART MOULD

Tinplate



GOBEL

Réf.	↔	↗	I	📦	> <
125710	29/27,5	20,5/19,5	2,5	0,31	5/10

RECTANGULAR FLUTED TART MOULD - REMOVABLE BOTTOM

Easy and practical demoulding thanks to the movable bottom.

Tinplate



GOBEL

Réf.	↔	↗	I	📦	> <
125810	29/27,5	20,5/19,5	2,5	0,43	5/10

OBLONG FLUTED TART MOULD

Tinplate



GOBEL

Réf.	↔	↗	I	📦	> <
125310	35/34	11/10	2,5	0,23	5/10

OBLONG FLUTED TART MOULD - REMOVABLE BOTTOM

Easy and practical demoulding thanks to the removable bottom.

Tinplate



GOBEL

Réf.	↔	↗	I	📦	> <
125410	35/34	11/10	2,5	0,26	5/10

The dimensions are expressed in cm, the weight in kg.
www.louistellier.fr

PERFORATED OBLONG FLUTED TART MOULD - REMOVABLE BOTTOM

Easy and practical demoulding thanks to the removable bottom.

Tinplate



GOBEL

Réf.	↔	↗	⊥	📦	> <
125412	35/34	11/10	2,5	0,26	5/10

RECTANGULAR FLUTED TARTLET MOULD - REMOVABLE BOTTOM

Easy and practical demoulding thanks to the removable bottom.

Tinplate



GOBEL

Réf.	↔	↗	⊥	📦	> <
195330	12/11,2	7,5/6,6	2	0,1	5/10

SQUARE FLUTED TART MOULD

Tinplate



GOBEL

Réf.	↔	↗	⊥	📦	> <
126710	23/22	23/22	2,5	0,28	5/10

SQUARE FLUTED TART MOULD - REMOVABLE BOTTOM

Easy and practical demoulding thanks to the removable bottom.

Tinplate



GOBEL

Réf.	↔	↗	⊥	📦	> <
126810	23/22	23/22	2,5	0,37	5/10

SQUARE FLUTED TARTLET MOULD

Tinplate



GOBEL

Réf.	↔	↗	⊥	📦	> <
194370	10/9	10/9	2	0,06	5/10

SQUARE FLUTED TARTLET MOULD - REMOVABLE BOTTOM

Easy and practical demoulding thanks to the removable bottom.

Tinplate



GOBEL

Réf.	↔	↗	⊥	📦	> <
194470	10/9	10/9	2	0,07	5/10

ROUND PLAIN CAKE MOULD

Rolled edges.

Tinplate



GOBEL

Réf.	∅	I	📦	> <
123701	10/9	3	0,07	5/10
123702	12/10,5	3,5	0,09	5/10
123705	14/11,7	3,5	0,12	5/10
123710	16/13,6	4	0,15	5/10
123720	18/15,3	4,5	0,18	5/10
123730	20/17,5	4,5	0,23	5/10
123740	22/19,5	5	0,27	5/10
123750	24/21	5	0,29	5/10
123760	26/23,5	5	0,34	5/10
123770	28/25	5	0,39	5/10
123780	30/27,5	5,5	0,46	5/10
123790	32/29,5	5,5	0,51	5/10

ROUND FLUTED CAKE MOULD - REMOVABLE BOTTOM

Narrow ribs. Easy and practical demoulding thanks to the removable bottom.

Tinplate



GOBEL

Réf.	∅	I	📦	> <
124810	10/8	3	0,07	5/10
124820	15/13	4	0,19	5/10

ROSARY MOULD

Rolled edges.

Tinplate



GOBEL

Réf.	∅	I	📦	> <
122130	20/17,5	5	0,23	5/10

SPRINGFORM CAKE PAN

2 bottoms : 1 flat + 1 fluted with tube. Easy demoulding thanks to the hinge.

Tinplate



GOBEL

Réf.	∅	I	📦	> <
121650	24	5,8	0,39	3/10
121660	26	5,8	0,44	3/10

SQUARE CAKE MOULD

Reinforced rolled edges.

Tinplate

GOBEL

Ref.					
124110	22/20,5	22/20,5	5	0,43	5/10
124120	24/22,5	24/22,5	5	0,48	5/10

SQUARE CAKE MOULD - REMOVABLE BOTTOM

Reinforced rolled edges. Easy unmoulding thanks to the mobile bottom.

Tinplate

GOBEL

Ref.					
124210	22/20,5	22/20,5	5	0,52	5/10
124220	24/22,5	24/22,5	5	0,6	5/10

BAKING SHEET

Reinforced rolled edges. In tin plate, guarantee of caramelization and crispiness on the outside.

Tinplate

BEST SELLER



GOBEL

Réf.					
125100	30/30,8	20/20,8	3,5	0,46	5/10
125105	35/35,8	25/25,8	3,5	0,6	5/10
125110	40/41,4	30/31,4	3,5	1,03	5/10

SAVARIN OR RING MOULD

Open cylinder. Stamped. Savarin, crown shape. Ideal for rum baba and king cake.

Tinplate

BEST SELLER



GOBEL

Réf.				
124040	22	4,5	0,26	5/10
124050	24	5	0,3	5/10

DEEP SAVARIN OR RING MOULD

Open cylinder. Stamped. In tinplate, a guarantee of caramelization and crispness on the outside.

Tinplate

BEST SELLER



GOBEL

Réf.				
154050	24	5,8	0,35	5/10
154060	26	6	0,41	5/10

TROIS FRERES - TWISTED SAVARIN OR RING MOULD

Open cylinder. Stamped. Savarin, crown shape. Ideal for rum baba and king cake.

Tinplate



GOBEL

Réf.				
124340	22	5,5	0,36	5/10

SINGLE SERVING SAVARIN MOULD - CLOSED CYLINDER

Closed cylinder. Savarin, crown shape. Ideal for rum baba and king cake.

Tinplate

BEST SELLER



GOBEL

Réf.				
123930	8	2	0,04	5/10

SINGLE SERVING SAVARIN MOULD - OPEN CYLINDER

Open cylinder. Savarin, crown shape. Ideal for rum baba and king cake.

Tinplate



GOBEL

Réf.				
124030	8	2	0,04	5/10
124034	12	2,5	0,09	5/10

CHARLOTTE MOULD

Stamped.

Tinplate

GOBEL

Ref.	∅	I	Weight	> <
112620	18/15	10	0,3	5/10

DIPLOMATE OR BAVAROIS MOULD

For dessert and jellies - stamped

Tinplate

GOBEL

Ref.	∅	I	Weight	> <
124610	18/15	9	0,26	5/10

TRADITIONAL FRENCH CHEESECAKE MOULD

In tinplate, a guarantee of caramelization and crispness on the outside.

Tinplate

GOBEL

Ref.	∅	I	Weight	> <
151210	14/7	4	0,11	5/10

BOX OF 30 PETITS-FOURS MOULDS

6 x 5 assorted models: fluted round + fluted square + diamond-shaped boat + plain round + plain diamond

Tinplate



GOBEL

Réf.	∅	h	l	g	> <
185400	12	3	0,24		5/10

PETITS-FOURS MOULDS

Tinplate



GOBEL



Réf.	∅	h	l	g	Model	> <
191010	6			0,01	Plain diamond	5/10
191510	6			0,01	Diamond-shaped boat	5/10
192010	5			0,01	Plain rectangle	5/10
192510		3,5	1,5	0,01	Deep plain round	5/10
193510		4,5		0,01	Fluted round	5/10
193610		3,5/2,2	1	0,01	Round plain tartlet mould	5/10
193620		4/2,6	1	0,01	Round plain tartlet mould	5/10
194020	7	2,8	1	0,01	Plain boat-shaped mould	5/10
195010		3,5	1	0,01	Fluted square	5/10
195510		4,5		0,01	Ribbed dome	5/10
196010		4,5		0,01	Fluted oval	5/10
196510		4,5		0,01	Ribbed oval	5/10

BOAT SHAPED MOULD

Tinplate



GOBEL



Réf.	∅	h	l	g	> <
194030	8	3,3	1,2	0,01	5/10
194040	9	4	1,2	0,01	5/10
194050	10	4,3	1,3	0,02	5/10
194060	11	4,6	1,3	0,02	5/10
194070	12	5	1,3	0,02	5/10

FLUTED BOAT SHAPED MOULD

Tinplate



GOBEL



Réf.	∅	h	l	g	> <
194110	8	4	1,2	0,02	5/10
194120	9	4,3	1,2	0,02	5/10
194130	10	4,5	1,2	0,02	5/10
194140	11	4,7	1,3	0,02	5/10
194150	12	5	1,4	0,01	5/10

OVAL PLAIN BOTTOM ASPIC MOULD

Perfect for preparing eggs in jelly, terrines or mousses. Stamped, bordered.

Tinplate



GOBEL



Réf.	∅	h	l	g	> <
130210	7,5	5,5	3,8	0,04	5/10

OVAL STAR BOTTOM ASPIC MOULD

Perfect for preparing eggs in jelly, terrines or mousses. Stamped. Edged.

Tinplate



GOBEL



Réf.	∅	h	l	g	> <
130310	7,5	5,5	3,8	0,04	5/10

RUM BABA MOULD

Stamped. Reinforced rolled edges. In tin plate, guarantee of caramelization and crispiness on the outside.

Tinplate



GOBEL

Réf.	∅	I	📦	> <
129810	6/4,8	6	0,05	5/10

MUFFIN MOULD

Tinplate



GOBEL

Réf.	↔	↗	I	📦	> <
196511	7	7	3,5	0,02	5/10

PASTÉIS DE NATA

Tinplate



GOBEL

Réf.	∅	I	📦	🔍	> <
196515	7,5	2	0,03	The unit	5/10
196517	7,5	7,8	0,62	Set of 24	5/10

BOX OF 6 PASTEIS DE NATA

Tinplate



GOBEL

Réf.	∅	I	📦	> <
196516	7,5	2,5	0,17	5/10





THE PROFESSIONAL PAPER MOULD

«THE PRACTICALITY»

100% BIODEGRADABLE MATERIAL

- Natural paper mould
- Compostable at home*

EASY AND QUICK TO REMOVE FROM THE MOULD

- No fat, perfect demoulding
- Professional quality
- The natural mould used in bakery is finally available to all consumers

EXCELLENT HEAT CONDUCTOR

- Perfect and homogeneous baking
- Fast heat up to 220°C

* Tart and tartlet mould



CHEF'S NOTE

Ideal for your events (picnics, birthdays, etc.) for sweet and savory recipes

HOW TO USE

- Single use
- Oven and microwave cooking
- Refrigerator and freezer
- Avoid humidity



PACK 15 PROFESSIONAL TART MOULDS - ORIGINE

100% natural and biodegradable. The first professional disposable baking mold accessible to the consumer. ideal for events, picnics...

Paper



GOBEL

Ref.				
GL19P004	24,6	2,3	0,01	Biodegradable - Compostable

PACK OF 15 PROFESSIONAL CAKE MOULDS - ORIGINE

100% natural and biodegradable. The first professional disposable baking mold accessible to the consumer. ideal for events, picnics...

Paper



GOBEL

Ref.			
GL19P005	23,3	7,3	Biodegradable

PACK OF 25 PROFESSIONAL CAKE MEDIUM MOULDS - ORIGINE

100% natural and biodegradable. The first professional disposable baking mold accessible to the consumer. ideal for events, picnics...

Paper



GOBEL

Ref.			
GL19P006	19	5,5	Biodegradable

PACK OF 50 PROFESSIONAL MUFFIN MOULDS - ORIGINE

100% natural and biodegradable. The first professional disposable baking mold accessible to the consumer. ideal for events, picnics...

Paper



GOBEL

Ref.			
GL19P001	7,2	4	Biodegradable



COBEL
Made in France

100

STAINLESS STEEL

EDGED TART & CUSTARD PIE RINGS	246
EDGELESS TART & CUSTARD PIE RINGS	249
STAINLESS STEEL SHAPES	252
HEAVY CAKE FRAMES	261
GUTTERS & YULE-LOG MOULDS	263

TART RING - ROLLED EDGES

Stainless steel

GOBEL

Ref.	∅	I	Ⓢ	> <
824910	7	2	0,02	4/10
824920	8	2	0,03	4/10
824930	9	2	0,03	4/10
824940	10	2	0,03	4/10
824945	11	2	0,04	4/10
824941	12	2	0,04	4/10
824942	14	2	0,05	4/10
824943	16	2	0,05	4/10
824944	18	2	0,06	4/10
824950	20	2	0,06	4/10
824960	22	2	0,07	4/10
824970	24	2	0,08	4/10
824980	26	2	0,08	4/10
824990	28	2	0,09	4/10
824992	30	2	0,1	4/10
824994	32	2	0,11	4/10

DEEP TART RING - ROLLED EDGES

Stainless steel

GOBEL

Ref.	∅	I	Ⓢ	> <
834910	7	2,7	0,03	4/10
834920	8	2,7	0,03	4/10
834930	9	2,7	0,04	4/10
834940	10	2,7	0,04	4/10
834941	12	2,7	0,05	4/10
834942	14	2,7	0,06	4/10
834943	16	2,7	0,07	4/10
834944	18	2,7	0,08	4/10
834950	20	2,7	0,08	4/10
834960	22	2,7	0,09	4/10
834970	24	2,7	0,1	4/10
834980	26	2,7	0,1	4/10
834990	28	2,7	0,11	4/10
834992	30	2,7	0,12	4/10
834994	32	2,7	0,13	4/10

SET OF 4 TART RINGS

Stainless steel

GOBEL

Ref.	∅	I	Ⓢ	> <
889830	9	2	0,14	4/10

BOX OF 6 ST/ST BISCUITS RINGS

Stainless steel

GOBEL

Ref.	∅	I	Ⓢ	> <
834995	5,5	1,2	0,1	4/10

SQUARE TART RING - ROLLED EDGES

For cooking or dressing.

Stainless steel



GOBEL

Ref.						
835530	18	18	2,7	0,17	4/10	
835540	20	20	2,7	0,19	4/10	
835550	22	22	2,7	0,21	4/10	
835560	24	24	2,7	0,23	4/10	
865530	18	18	2	0,16	4/10	
865540		20	20	2	0,18	4/10
865550	22	22	2	0,19	4/10	
865560	24	24	2	0,21	4/10	

RECTANGULAR TART RING - ROLLED EDGES

For cooking or dressing.

Stainless steel



GOBEL

Ref.						
865310		35	11	2	0,2	4/10
865320	55	11	2	0,29	4/10	

ADJUSTABLE CAKE RING

FRANCE 1887
GOBEL
 rien ne remplace le fait main

MATÉRIAU - MATERIAL
RECYCLABLE
 SAIN / HEALTHY

Made in
 France

SANS
 FREE
**BPA
 PFOA**

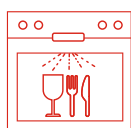

All diameters **possible**
 from **16 to 28 cm**

The interior is
 graduated every **2 cm**

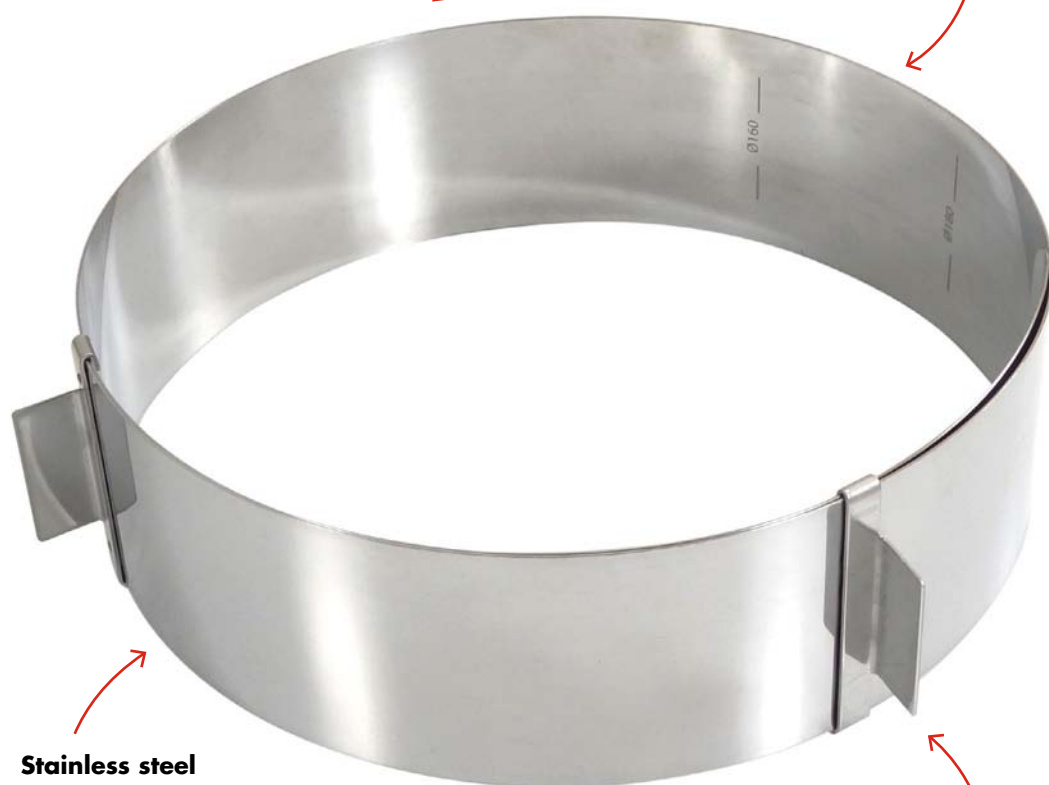

Stainless steel

Locks at the **desired size**
 using the fixing loop

Ideal for making recipes using raw vegetarian pastry and for tiered cakes, it is the professional pastry chef's tool for making cakes, gâteaux, mousses, intermediate courses, and vacherins. Perfect for careful presentation of savoury dishes: tians, parmentier, etc.

Instructions for use

- Tighten the handles to reduce the size of the circle, and loosen them to widen the circle,
- Move the loop to the left to lock the circle, and to the right to unlock it,
- Use on a pastry plate covered with baking paper.

ADJUSTABLE CAKE RING

Adjustable from 160 to 280 mm.

 Stainless steel



GOBEL

Réf.	∅	I	📦	> <
896480	16/28	6	0,27	6/10

PASTRY RING H50

For cooking or dressing.

 Stainless steel



GOBEL

Réf.	∅	I	📦	> <
866420	5	5	0,04	6/10
866440	6	5	0,05	6/10
866460	7	5	0,05	6/10
866480	8	5	0,06	6/10

MOUSSE RING H40

 Stainless steel



GOBEL

Réf.	∅	I	📦	> <
865001	5	4	0,03	6/10
865003	6	4	0,04	6/10
865004	6,5	4	0,04	6/10
866260	7	4	0,04	6/10
865000	7,5	4	0,04	6/10
866280	8	4	0,05	6/10

CUSTARD RING H35

For cooking or dressing.

 Stainless steel



GOBEL

Réf.	∅	I	📦	> <
865102	8	3,5	0,07	6/10
865104	10	3,5	0,07	10/10
865105	11	3,5	0,1	10/10
865110	14	3,5	0,11	10/10
865120	16	3,5	0,14	10/10
865130	18	3,5	0,16	10/10
865140	20	3,5	0,17	10/10
865150	22	3,5	0,19	10/10
865160	24	3,5	0,21	10/10
865170	26	3,5	0,22	10/10
865180	28	3,5	0,24	10/10
865190	30	3,5	0,26	10/10

SET OF 4 RINGS AND PUSHER

Pusher : ∅ 68 mm. Rings : ∅ 70 x 40 mm

 Stainless steel



GOBEL

Réf.	I	📦	> <
813850	4	0,27	6/10

MOUSSE RING H45

Stainless steel

GOBEL

Réf.	∅	I	⊞	> <
866320	5	4,5	0,03	6/10
866330	5,5	4,5	0,04	6/10
866340	6	4,5	0,04	6/10
866350	6,5	4,5	0,04	6/10
866360	7	4,5	0,05	6/10
866370	7,5	4,5	0,05	6/10
865010	8	4,5	0,05	6/10
865011	9	4,5	0,06	6/10
865012	10	4,5	0,09	8/10
865020	12	4,5	0,11	8/10
865030	14	4,5	0,12	10/10
865040	16	4,5	0,18	10/10
865050	18	4,5	0,2	10/10
865060	20	4,5	0,22	10/10
865070	22	4,5	0,24	10/10
865080	24	4,5	0,27	10/10
865090	26	4,5	0,29	10/10
865092	28	4,5	0,3	10/10
896450	36	4,5	0,76	10/10

TRIO MOUSSE RING

Convex - removable separation

Stainless steel

GOBEL

Réf.	∅	I	⊞	> <
890850	18	4,5	0,35	10/10

DUO MOUSSE RING

Convex. Removable separation.

Stainless steel

GOBEL

Réf.	∅	I	⊞	> <
890650	18	4,5	0,31	10/10

RAIL OF 6 MOUSSE RINGS

Stainless steel







GOBEL

Réf.	∅	I	⊞	> <	
877821	45	7,5	4	0,41	6/10

ICE CREAM CAKE RING

 Stainless steel

GOBEL

Ref.				
865680	8	6	0,07	10/10
865690	9	6	0,08	10/10
864904	10	6	0,09	10/10
864905	12	6	0,18	10/10
864910	14	6	0,17	10/10
864920	16	6	0,24	10/10
864930	18	6	0,26	10/10
864940	20	6	0,3	10/10
864950	22	6	0,33	10/10
864960	 24	6	0,35	10/10
864970	26	6	0,38	10/10
864980	28	6	0,41	10/10
864990	30	6	0,44	10/10
898250	36	6	1,04	20/10
898270	40	6	1,15	20/10

ROUND SHAPE

For cooking or dressing.

Stainless steel

GOBEL

Réf.	∅	I	⊞	> <
866004	4	3	0,02	6/10
866005	5	3	0,02	6/10
866010	5,5	3	0,03	6/10
866020	6	3	0,03	6/10
866030	6,5	3	0,03	6/10
866040	7	3	0,03	6/10
866050	7,5	3	0,03	6/10
866060	8	3	0,04	6/10

ROUND PUSHER

Stainless steel

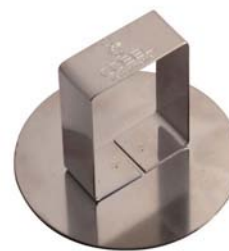
GOBEL

Réf.	∅	I	⊞	> <
866600	4,8	4,7	0,03	10/10
866610	5,8	4,7	0,03	10/10
866630	6,8	4,7	0,04	10/10
866632	7,8	4,7	0,05	10/10
866640	7,3	4,7	0,04	10/10
866650	8,8	4,7	0,06	10/10
866660	9,8	4,7	0,07	10/10

SQUARED CAKE FRAME

For cooking or dressing.

Stainless steel

GOBEL

Réf.	∞	∞	I	⊞	> <
897000	8	8	2	0,05	20/10
869005	4	4	3	0,02	6/10
869010	5	5	3	0,03	6/10
869030	6	6	3	0,03	6/10
871220	3	3	3	0,02	6/10
867420	6	6	4	0,04	6/10
867430	7	7	4	0,05	6/10
864840	7	7	4,5	0,06	6/10
863310	8	8	4,5	0,09	8/10
863320	10	10	4,5	0,11	8/10
863322	12	12	4,5	0,13	10/10
863330	16	16	4,5	0,22	10/10
863340	18	18	4,5	0,25	10/10
863350	20	20	4,5	0,28	10/10
863360	22	22	4,5	0,3	10/10
863370	24	24	4,5	0,33	10/10

SET OF 4 ST/ST SQUARE PASTRY RINGS AND PUSHER

 For cooking or dressing.
 Squares : L 70 mm. Pusher : 68 mm.

Stainless steel

GOBEL

Réf.	∞	∞	I	⊞	> <
887980	14	14	4	0,3	6/10

SQUARE PUSHER

Stainless steel



GOBEL

Réf.	⊖	↗	⊥	⊞
866750	5,8	5,8	4,7	0,04
866755	6,8	6,8	4,7	0,04

RECTANGULAR CAKE FRAME

For cooking or dressing.

Stainless steel



GOBEL

Réf.	⊖	↗	⊥	⊞	> <
867505	5	3	3	0,02	6/10
867530	6	3	3	0,02	6/10
867510	6	5	3	0,03	6/10
867740	8	4	3	0,05	6/10
877630	9	3,5	3	0,05	8/10
867540	10	3	3	0,05	8/10
867560	12	3	3	0,06	8/10
867760	12	4	3	0,05	8/10
867360	12	4	3,5	0,09	10/10
864330	12	6	4,5	0,13	8/10
864350	16	8	4,5	0,16	10/10
864370	20	10	4,5	0,21	10/10
864390	24	12	4,5	0,24	10/10
875910	8	5,5	5,5	0,09	8/10

SET OF 4 ST/ST RECTANGULAR CAKE FRAMES AND PUSHER

Rectangles: 90 x 30 x 35 mm . Pusher: 88 x 28 mm

Stainless steel

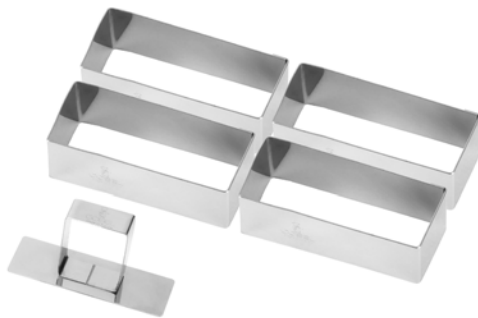

GOBEL

Réf.	⊖	↗	⊥	⊞
881780	12,5	13,5	3,5	0,25

RECTANGULAR PUSHER

Stainless steel



GOBEL

Réf.	⊖	↗	⊥	⊞
866740	8,8	2,8	4,7	0,03

NUMBERS

For cooking or dressing your preparations in shape of numbers.

Stainless steel

GOBEL

Réf.					
884420	20	12	4,5	0,2	0 - Delivery time : 3 to 4 weeks
884421	20	12	4,5	0,22	1 - Delivery time : 3 to 4 weeks
884422	20	12	4,5	0,25	2 - Delivery time : 3 to 4 weeks
884423	20	12	4,5	0,26	3 - Delivery time : 3 to 4 weeks
884424	20	12	4,5	0,21	4 - Delivery time : 3 to 4 weeks
884425	20	12	4,5	0,27	5 - Delivery time : 3 to 4 weeks
884426	20	12	4,5	0,19	6 - Delivery time : 3 to 4 weeks
884427	20	12	4,5	0,24	7 - Delivery time : 3 to 4 weeks
884428	20	12	4,5	0,2	8 - Delivery time : 3 to 4 weeks
884429	20	12	4,5	0,23	9 - Delivery time : 3 to 4 weeks
884430	30	18	4,5	0,29	0 - Delivery time : 3 to 4 weeks
884431	30	18	4,5	0,32	1 - Delivery time : 3 to 4 weeks
884432	30	18	4,5	0,37	2 - Delivery time : 3 to 4 weeks
884433	30	18	4,5	0,39	3 - Delivery time : 3 to 4 weeks
884434	30	18	4,5	0,32	4 - Delivery time : 3 to 4 weeks
884435	30	18	4,5	0,4	5 - Delivery time : 3 to 4 weeks
884436	30	18	4,5	0,29	6 - Delivery time : 3 to 4 weeks
884437	30	18	4,5	0,36	7 - Delivery time : 3 to 4 weeks
884438	30	18	4,5	0,29	8 - Delivery time : 3 to 4 weeks
884439	30	18	4,5	0,35	9 - Delivery time : 3 to 4 weeks

LETTERS

For cooking or dressing your preparations in shape of letters.

Stainless steel

GOBEL

Réf.					
884641	20	21,5	4,5	0,27	A - Delivery time : 3 to 4 weeks
884642	20	18,5	4,5	0,26	B - Delivery time : 3 to 4 weeks
884643	20	20	4,5	0,31	C - Delivery time : 3 to 4 weeks
884644	20	19	4,5	0,24	D - Delivery time : 3 to 4 weeks
884645	20	17,4	4,5	0,4	E - Delivery time : 3 to 4 weeks
884646	20	15,5	4,5	0,3	F - Delivery time : 3 to 4 weeks
884647	20	20	4,5	0,34	G - Delivery time : 3 to 4 weeks
884648	20	19,5	4,5	0,38	H - Delivery time : 3 to 4 weeks
884649	20	7	4,5		I - Delivery time : 3 to 4 weeks
884650	20	16	4,5	0,26	J - Delivery time : 3 to 4 weeks
884651	20	21,7	4,5	0,39	K - Delivery time : 3 to 4 weeks
884652	20	16	4,5	0,24	L - Delivery time : 3 to 4 weeks
884653	20	22,7	4,5	0,51	M - Delivery time : 3 to 4 weeks
884654	20	19	4,5	0,38	N - Delivery time : 3 to 4 weeks
884655	20	20	4,5	0,23	O - Delivery time : 3 to 4 weeks
884656	20	17	4,5	0,24	P - Delivery time : 3 to 4 weeks
884657	20	22	4,5	0,25	Q - Delivery time : 3 to 4 weeks
884658	20	20	4,5	0,32	R - Delivery time : 3 to 4 weeks
884659	20	16,5	4,5	0,35	S - Delivery time : 3 to 4 weeks
884660	20	19,2	4,5	0,28	T - Delivery time : 3 to 4 weeks
884661	20	21,7	4,5	0,36	U - Delivery time : 3 to 4 weeks
884662	20	21	4,5	0,32	V - Delivery time : 3 to 4 weeks
884663	20	27,8	4,5	0,47	W - Delivery time : 3 to 4 weeks
884664	20	21	4,5	0,36	X - Delivery time : 3 to 4 weeks
884665	20	22,4	4,5	0,29	Y - Delivery time : 3 to 4 weeks
884666	20	19,5	4,5	0,37	Z - Delivery time : 3 to 4 weeks



Réf.

1 FACETED SQUARE CAKE FRAME

For cooking or dressing your preparations in square shape.

869330	6	6	3	0,03	Delivery time : 3 to 4 weeks
863410	8	8	4,5	0,06	Delivery time : 3 to 4 weeks

2 CONVEX SQUARE

For cooking or dressing your preparations in square shape.

869110	5	5	3	0,03	Delivery time : 3 to 4 weeks
869130	6	6	3	0,03	Delivery time : 3 to 4 weeks
863510	8	8	4,5	0,08	Delivery time : 3 to 4 weeks
863540	18	18	4,5	0,22	Delivery time : 3 to 4 weeks

3 CONCAVE SQUARE

For cooking or dressing your preparations in square shape.

869230	6	6	3	0,04	Delivery time : 3 to 4 weeks
--------	---	---	---	------	------------------------------

4 DUO MOUSSE SQUARE

For cooking or dressing your preparations in square shape.

860430	12	12	4,5	0,19	Delivery time : 3 to 4 weeks
--------	----	----	-----	------	------------------------------

5 CAKE FRAME - HALF MOON

For cooking or dressing.

868710	6	3	3	0,02	Delivery time : 3 to 4 weeks
868730	8,5	4,5	3	0,03	Delivery time : 3 to 4 weeks

6 CAKE FRAME - WATERDROP / PETAL

For cooking or dressing.

868110	9	6	3	0,03	Delivery time : 3 to 4 weeks
863790	28	17,5	4,5	0,24	Delivery time : 3 to 4 weeks

Réf.

7 CAKE FRAME - HEXAGON

For cooking or dressing.

866510	6	6	3	0,03	Delivery time : 3 to 4 weeks
862760	22	22	4,5	0,27	Delivery time : 3 to 4 weeks
862740	18	18	4,5	0,22	Delivery time : 3 to 4 weeks
862750	20	20	4,5	0,24	Delivery time : 3 to 4 weeks

8 CAKE FRAME - TEARDROP

For cooking or dressing.

868610	9	5	3	0,03	Delivery time : 3 to 4 weeks
--------	---	---	---	------	------------------------------

9 CAKE FRAME - DIAMOND

For cooking or dressing.

867010	9	6	3	0,03	Delivery time : 3 to 4 weeks
--------	---	---	---	------	------------------------------

10 CAKE FRAME - MOON

For cooking or dressing.

864180	26	16	4,5	0,29	Delivery time : 3 to 4 weeks
--------	----	----	-----	------	------------------------------

11 CAKE FRAME - THE HAMZA (HAND OF FATIMA)

For cooking or dressing.

884048	10	7	3	0,3	Delivery time : 3 to 4 weeks
884049	7	5	3	0,21	Delivery time : 3 to 4 weeks

12 CAKE FRAME - OVAL

For cooking or dressing.

868010	7,5	4,5	3	0,03	Delivery time : 3 to 4 weeks	868010
883948	10,5	6	4,5	0,05	Delivery time : 3 to 4 weeks	883948

13

14

15

16

17

18

19

20

21

22

23

24

Réf.

13 CAKE FRAME - OBLONG

For cooking or dressing.

884017	11	4	3	0,04	Delivery time : 3 to 4 weeks
--------	----	---	---	------	------------------------------

14 CAKE FRAME - TRIANGLE

For cooking or dressing.

869530	7	6	3	0,03	Delivery time : 3 to 4 weeks
863010	9	8	4,5	0,08	Delivery time : 3 to 4 weeks
863020	11	10	4,5	0,1	Delivery time : 3 to 4 weeks
863050	23	20	4,5	0,25	Delivery time : 3 to 4 weeks
863070	27,5	24	4,5	0,29	Delivery time : 3 to 4 weeks

15 CAKE FRAME - TRIANGLE FACETED

For cooking or dressing.

863110	9	8	4,5	0,06	Delivery time : 3 to 4 weeks
--------	---	---	-----	------	------------------------------

16 CAKE FRAME - CONVEX TRIANGLE

For cooking or dressing.

869610	6	6	3	0,03	Delivery time : 3 to 4 weeks
869630	7	7	3	0,03	Delivery time : 3 to 4 weeks
863260	19	19	4,5	0,21	Delivery time : 3 to 4 weeks

17 CAKE FRAME - CONCAVE TRIANGLE

For cooking or dressing.

869730	8	7,5	3	0,05	Delivery time : 3 to 4 weeks
--------	---	-----	---	------	------------------------------

18 CAKE FRAME - COMMA

For cooking or dressing.

868630	16	10	4,5	0,16	Delivery time : 3 to 4 weeks
868640	20	13	4,5	0,19	Delivery time : 3 to 4 weeks
868660	24	16	4,5	0,23	Delivery time : 3 to 4 weeks
868680	28	19	4,5	0,28	Delivery time : 3 to 4 weeks

Réf.

19 CAKE FRAME - SOCCER JERSEY

For cooking or dressing.

883972	26,5	25,5	4,5	0,34	On demand
--------	------	------	-----	------	-----------

20 CAKE FRAME - STAR

For cooking or dressing.

884139	5	1,5	0,01	Delivery time : 3 to 4 weeks	
896630	8	8	3	0,04	Delivery time : 3 to 4 weeks
896635	10	9	4,5	0,07	Delivery time : 3 to 4 weeks

21 CAKE FRAME - HEART

For cooking or dressing.

868510	6,5	6	3	0,07	Delivery time : 3 to 4 weeks
883901	18	16	4,5	0,19	Delivery time : 3 to 4 weeks
883902	23	20	4,5	0,24	Delivery time : 3 to 4 weeks
883903	27,5	24	4,5	0,28	Delivery time : 3 to 4 weeks

22 CAKE FRAME - INTERLACED HEARTS

For cooking or dressing.

884023	14	8	3	0,07	Delivery time : 3 to 4 weeks
--------	----	---	---	------	------------------------------

23 CAKE FRAME - CONVEX HEART

For cooking or dressing.

884032	8,5	8,5	3	0,04	Delivery time : 3 to 4 weeks
--------	-----	-----	---	------	------------------------------

24 CAKE FRAME - ERMINE (BRITTANY)

For cooking or dressing.

884018	10	7,5	3	0,05	Delivery time : 3 to 4 weeks
--------	----	-----	---	------	------------------------------

25



26



27



28



29



30



31



32



33



34



35



36



Réf.

25 CAKE FRAME - CARROT

For cooking or dressing.

884035	12	4,5	3	0,05	Delivery time : 3 to 4 weeks
884106	14	5,5	1,5	0,22	Delivery time : 3 to 4 weeks

26 CAKE FRAME - MUSHROOM

For cooking or dressing.

868810	7	7	3	0,04	Delivery time : 3 to 4 weeks
884034	12	12	1,5	0,08	Delivery time : 3 to 4 weeks

27 CAKE FRAME - TURNIP

For cooking or dressing.

884105	10	10,5	1,5	0,02	Delivery time : 3 to 4 weeks
--------	----	------	-----	------	------------------------------

28 CAKE FRAME - POTATO

For cooking or dressing.

884104	12,5	8	1,5	0,02	Delivery time : 3 to 4 weeks
--------	------	---	-----	------	------------------------------

29 CAKE FRAME - LAMB CHOP

For cooking or dressing.

884013	10	5,5	3	0,04	Delivery time : 3 to 4 weeks
884101	14	4,5	1,5	0,03	Delivery time : 3 to 4 weeks

30 CAKE FRAME - CHICKEN DRUMSTICK

For cooking or dressing.

884031	10	5	3	0,04	Delivery time : 3 to 4 weeks
--------	----	---	---	------	------------------------------

Réf.

31 CAKE FRAME - FISH

For cooking or dressing.

884015	10	5	3	0,04	Delivery time : 3 to 4 weeks
883907	30	18,5	4,5	0,3	Delivery time : 3 to 4 weeks

32 CAKE FRAME - TROPICAL FISH

For cooking or dressing.

884012				0,04	
--------	--	--	--	------	--

33 CAKE FRAME - HORSE

For cooking or dressing.

884129	16	15,5	1,5	0,07	Delivery time : 3 to 4 weeks
--------	----	------	-----	------	------------------------------

34 CAKE FRAME - BEAR CUB

For cooking or dressing.

884021	10,5	7,5	3		Delivery time : 3 to 4 weeks
--------	------	-----	---	--	------------------------------

35 CAKE FRAME - BUTTERFLY

For cooking or dressing.

884019	12	15	3		Delivery time : 3 to 4 weeks
--------	----	----	---	--	------------------------------

36 BOX SET OF 4 CHRISTMAS NONNETTES

For cooking or dressing.

877310	26	13	3	0,23	Delivery time : 3 to 4 weeks
--------	----	----	---	------	------------------------------

GOBEL  Stainless steel

37



38



39



40



41



42



43



44



45



46



47



48



Réf. 

37 CAKE FRAME - ANGEL

For cooking or dressing.

884004	8	7	3	0,04	Delivery time : 3 to 4 weeks
--------	---	---	---	------	------------------------------

38 CAKE FRAME - BOOT

For cooking or dressing.

884145	5,5	5	1,5	0,01	Delivery time : 3 to 4 weeks
--------	-----	---	-----	------	------------------------------

39 SET OF 6 SMALL HOLIDAY SHAPES FOR SHORTBREAD COOKIES

With raffia + Gobel sticker with recipe - stainless steel

884154				0,1	Delivery time : 3 to 4 weeks
--------	--	--	--	-----	------------------------------

40 CAKE FRAME - SNOWMAN

For cooking or dressing.

896730	9	6,5	3	0,04	Delivery time : 3 to 4 weeks
--------	---	-----	---	------	------------------------------

41 CAKE FRAME - MAN MANNELE (ALSACE)

For cooking or dressing.

884115	7,5	5	1,5	0,02	Delivery time : 3 to 4 weeks
--------	-----	---	-----	------	------------------------------

884110	10,5	7	1,5	0,03	Delivery time : 3 to 4 weeks
--------	------	---	-----	------	------------------------------

884002	14	12	3	0,07	Delivery time : 3 to 4 weeks
--------	----	----	---	------	------------------------------

884120	19	14	1,5	0,07	Delivery time : 3 to 4 weeks
--------	----	----	-----	------	------------------------------

42 CAKE FRAME - WOMAN MANNELE (ALSACE)

For cooking or dressing.

884111	10,5	7	1,5	0,03	Delivery time : 3 to 4 weeks
--------	------	---	-----	------	------------------------------

Réf. 

884121	19	14	1,5	0,22	Delivery time : 3 to 4 weeks
--------	----	----	-----	------	------------------------------

43 CAKE FRAME - FALLING STAR

For cooking or dressing.

884141	10	3,5	1,5	0,02	Delivery time : 3 to 4 weeks
--------	----	-----	-----	------	------------------------------

884007	14	6	3	0,05	Delivery time : 3 to 4 weeks
--------	----	---	---	------	------------------------------

44 CAKE FRAME - SANTA CLAUS

For cooking or dressing.

884008	12	6,5	3	0,05	Delivery time : 3 to 4 weeks
--------	----	-----	---	------	------------------------------

884128	18	13,2	1,5	0,06	Delivery time : 3 to 4 weeks
--------	----	------	-----	------	------------------------------

45 CAKE FRAME - SAINT-NICOLAS

For cooking or dressing.

884130	20	8,8	1,5	0,06	Delivery time : 3 to 4 weeks
--------	----	-----	-----	------	------------------------------

46 CAKE FRAME - SNOWFLAKE

For cooking or dressing.

884108	11,5	10,5	1,5	0,05	Delivery time : 3 to 4 weeks
--------	------	------	-----	------	------------------------------

47 CAKE FRAME - SMALL HOUSE

For cooking or dressing.

884142	5,5	5	1,5	0,01	Delivery time : 3 to 4 weeks
--------	-----	---	-----	------	------------------------------

48 CAKE FRAME - REINDEER

For cooking or dressing.

884125	16	15,8	1,5	0,07	Delivery time : 3 to 4 weeks
--------	----	------	-----	------	------------------------------



49



50



51



52



53



54



55



56

Réf.

49 CAKE FRAME - CHRISTMAS TREE

For cooking or dressing.

884127	16	15,8	1,5	0,07	Delivery time : 3 to 4 weeks
884144	6	4,5	1,5	0,01	Delivery time : 3 to 4 weeks
896830	8	8	3	0,04	Delivery time : 3 to 4 weeks
896840	10	10	3	0,05	Delivery time : 3 to 4 weeks
896860	20	19,5	4,5	0,24	Delivery time : 3 to 4 weeks

50 CAKE FRAME - CUGNOLE (NORTH)

For cooking or dressing.

883908	26	9,5	4,5	0,21	Delivery time : 3 to 4 weeks
883943	15	7	4,5	0,12	Delivery time : 3 to 4 weeks
883944	32	11	4,5	0,26	Delivery time : 3 to 4 weeks

51 BOX SET OF 4 EASTER NONNETTES

For cooking or dressing.

873220	26	13	4,5	0,17	Delivery time : 3 to 4 weeks
--------	----	----	-----	------	------------------------------

52 CAKE FRAME - RABBIT

For cooking or dressing.

884001	9,5	8,5	3	0,04	Delivery time : 3 to 4 weeks
884132	18,5	10,5	1,5	0,06	Delivery time : 3 to 4 weeks
884122	21	12	1,5	0,06	Delivery time : 3 to 4 weeks

Réf.

53 CAKE FRAME - BELL

For cooking or dressing.

896930	7	6,9	3	0,03	Delivery time : 3 to 4 weeks
884123	15,5	15,5	1,5	0,05	Delivery time : 3 to 4 weeks
898960	20	20	4,5	0,23	Delivery time : 3 to 4 weeks

54 CAKE FRAME - EGG

For cooking or dressing.

884009	8	5,6	3	0,03	Delivery time : 3 to 4 weeks
884131	15	11	1,5	0,04	Delivery time : 3 to 4 weeks
883909	20	14	4,5	0,19	Delivery time : 3 to 4 weeks
883910	30	21	4,5	0,28	Delivery time : 3 to 4 weeks

55 CAKE FRAME - HEN

For cooking or dressing.

884005	9,5	9	3	0,04	Delivery time : 3 to 4 weeks
884124	15,5	15,5	1,5	0,05	Delivery time : 3 to 4 weeks

56 CAKE FRAME - GUADELOUPE

For cooking or dressing.

884501	15	10	3	0,1	Delivery time : 3 to 4 weeks
883918	35	23	4,5	0,42	Delivery time : 3 to 4 weeks
883946	45	30	4,5	0,54	Delivery time : 3 to 4 weeks
884712	60	36	6	1,15	Delivery time : 3 to 4 weeks

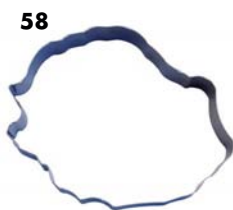

Réf.

57 CAKE FRAME - MARTINIQUE

For cooking or dressing.

884029	15	9,5	3	0,08	Delivery time : 3 to 4 weeks
883926	25	16	4,5	0,26	Delivery time : 3 to 4 weeks
883927	35	24,5	4,5	0,35	Delivery time : 3 to 4 weeks
883945	45	29	4,5	0,43	Delivery time : 3 to 4 weeks
884713	60	32	6	1,09	Delivery time : 3 to 4 weeks

58 CAKE FRAME - REUNION ISLAND

For cooking or dressing.

884030	15	11,5	3	0,08	Delivery time : 3 to 4 weeks
883924	25	20	4,5	0,25	Delivery time : 3 to 4 weeks
883925	35	26,5	4,5	0,35	Delivery time : 3 to 4 weeks

59 CAKE FRAME - FRENCH GUIANA

For cooking or dressing.

884028	15	12	3	0,09	Delivery time : 3 to 4 weeks
883928	25	21,5	4,5	0,19	Delivery time : 3 to 4 weeks
883929	36	27	4,5	0,37	Delivery time : 3 to 4 weeks

60 CAKE FRAME - CORSICA

For cooking or dressing.

884027	15	6	3	0,07	Delivery time : 3 to 4 weeks
883922	25	12	4,5	0,22	Delivery time : 3 to 4 weeks
883930	35	17,5	4,5	0,31	Delivery time : 3 to 4 weeks

Réf.

61 CAKE FRAME - FRANCE

For cooking or dressing.

883920	16	15	3	0,1	Delivery time : 3 to 4 weeks
883921	27	25,5	4,5	0,32	Delivery time : 3 to 4 weeks
883923	40	38	4,5	0,52	Delivery time : 3 to 4 weeks

62 CAKE FRAME - EIFFEL TOWER

For cooking or dressing.

884107	14	6	1,5	0,03	Delivery time : 3 to 4 weeks
884502	19	9	3	0,11	Delivery time : 3 to 4 weeks
883933	34	15	4,5	0,34	Delivery time : 3 to 4 weeks
883934	57	25	4,5	0,55	Delivery time : 3 to 4 weeks
884709	120	47	6	1,85	Delivery time : 3 to 4 weeks

63 CAKE FRAME - CANADA

For cooking or dressing.

883942	25	13	4,5	0,28	Delivery time : 3 to 4 weeks
884711	60	29,5	6	1,1	Delivery time : 3 to 4 weeks

64 CAKE FRAME - AFRICA

For cooking or dressing.

883953	35	32,5	4,5		Delivery time : 3 to 4 weeks
--------	----	------	-----	--	------------------------------

HEAVY CAKE FRAME

For cooking or dressing.

Stainless steel



GOBEL



Réf.					
888580	56,5	36,5	6	2,1	20/10
888610	57	9	4,5	0,48	20/10
888620	36	26	4,5	0,87	20/10
888630	40	30	4,5	1,02	20/10
888645	49	29	4,5	1,06	20/10
888650	50,9	30,7	4,5	1,13	20/10
888660	59,5	39,5	4,5	1,6	20/10
888680	56,5	36,5	4,5	1,29	20/10
888750	33	33	3,5	0,7	20/10
888760	50,9	30,7	3,5	0,9	20/10
888780	56,5	36,5	3,5	0,97	20/10

ADJUSTABLE EXTENDABLE CAKE FRAME

For cooking or dressing. Adjustable from 2 cm to 2 cm.

Stainless steel



GOBEL



Réf.				
896470	28	16	4,5	0,56

HEAVY CAKE FRAME WITH REMOVABLE INTERIOR DIVIDER

For cooking or dressing.

Stainless steel



GOBEL



Réf.				
895710	56,5	36,5	4,5	20/10

BAKING SHEET

Reinforced rolled edges.

Stainless steel



GOBEL



Réf.					
825150	38,6/40	23,6/30	3,5	1	5/10
825160	58,8/60	38,8/40	5	1,42	5/10

WATERTIGHT YULE-LOG MOULD



7-recipe booklet **included**

Watertight mould

Patented

Removable **non-slip** over-moulded silicone nozzles

Easy **demoulding**

Oven-compatible up to 230 °C

Thanks to its silicone nozzles, the Gobel patented stainless-steel yule-log mould enables easy demoulding whilst being watertight.

This mould is indispensable for successful Christmas logs. It is also used all year round for ice creams, terrines, aspics, tuiles, etc.

ROUNDED YULE-LOG MOULD

Patented.
Removable ends for easy turning out. Airtight. Recipe booklet included.

Stainless steel



GOBEL



Ref.					
814570	30	8,5	6,8	0,39	1,5 L
814580	50	8,5	6,8	0,65	2,5 L

ST/ST YULE LOG MOULD

Stainless steel



GOBEL



Ref.					
800710	30	9	7	0,4	6/10

LOG SQUEEGEE 65 X 60 MM

Stainless steel



GOBEL



Ref.						
817931	6,5	6	0,1	0,05	L	814570 814580

LOG SQUEEGEE 45 X 50 MM

Stainless steel



GOBEL



Ref.						
817932	4,5	5	0,1	0,04	M	814570 814580

LOG SQUEEGEE 25 X 40 MM

Stainless steel



GOBEL



Ref.						
817933	2,5	4	0,1	0,03	S	814570 814580

SET OF 3 LOG SQUEEGEE

Stainless steel



GOBEL



Ref.						
817930	6,5	6	0,3	0,12	3 sizes set	814570 814580



PASTRY SHEETS

PASTRY SHEETS

267

FLAT PERFORATED PASTRY SHEET



Microperforations
Enable excess humidity to be removed for cooking deep-frozen dough, and preserve crunchiness

Encourages hot-air circulation in the oven and around baking sheets

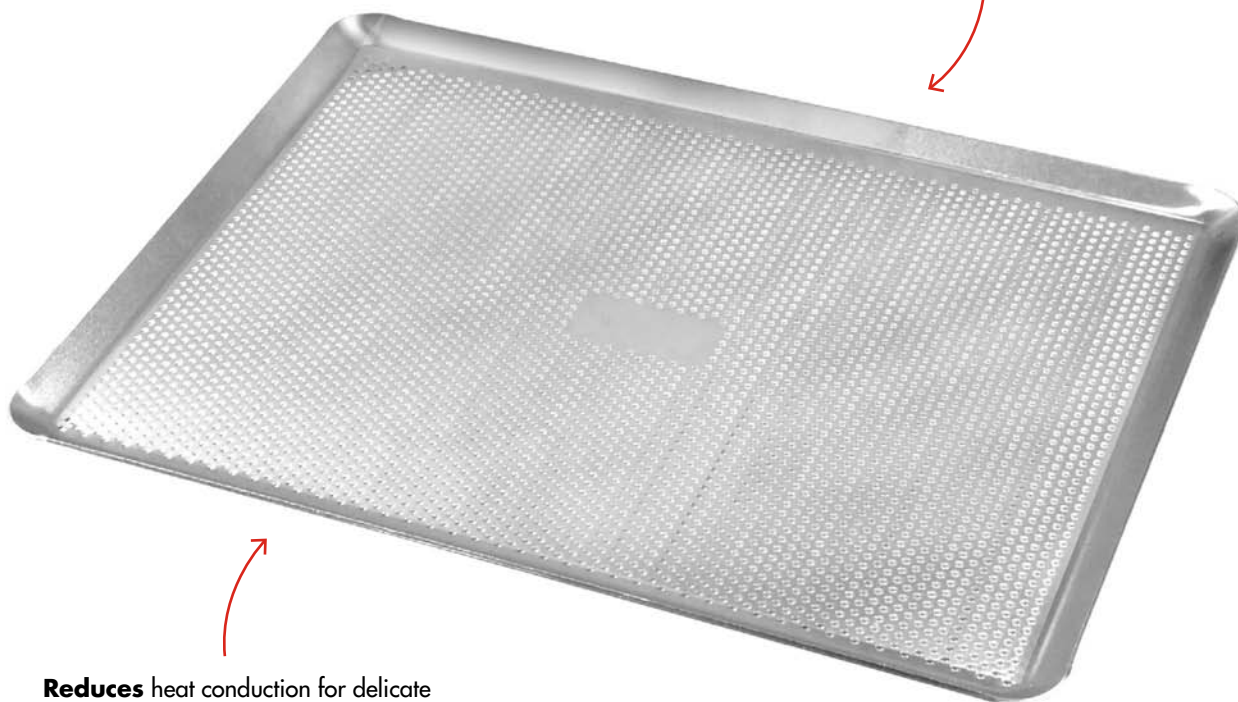

Reduces heat conduction for delicate preparations (macarons)

GOBEL's crimp-edged pastry sheet are available in stainless steel, aluminium, and non-stick coated aluminium.

Indispensable for oven cooking, they also serve as preparation and storage support in refrigerated cabinets and proof rooms.

ST/ST PASTRY SHEET

The stainless steel pastry sheets are both dishwasher and oven safe (maximum cooking temperature: 570°F / 300°C). You can also put them in the refrigerator (-4°F to +42,8°F / -20°C to +6°C). Perfect for storage.

Stainless steel



GOBEL

Réf.						
814550	40	30	1	0,9		> <
814560	53	32,5	1	1,35	GN 1/1	> <
814590	60	40	1	1,87		> <

PASTRY SHEET - STRAIGHT EDGES

Indispensable for cooking.

Stainless steel



GOBEL

Réf.						
814565	53	32,5	2	1,6	GN 1/1	> <
814595	60	40	3	2,05		> <

ALUMINIUM PASTRY SHEET

Aluminium



GOBEL

Réf.						
614530	40	30	1	0,64		> <
614580	53	32,5	1	0,71		> <
614590	60	40	1	1		> <

NON-STICK PASTRY SHEET

The aluminium with non-stick coating pastry sheets combine the thermal conductivity of the aluminium and the excellent non-stick properties of the four-layered coating, PFOA-free. The use of baking paper is unnecessary. They will last for a very long time and give you permanent satisfaction, thanks to the thickness of the sheets and the great quality of the non-stick coating.

Non-stick coated aluminium



GOBEL

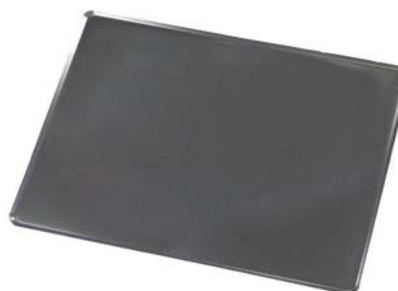

Réf.						
714510	30	15	1	0,25		> <
714530		40	30	1	0,65	> <
714560	53	32,5	1	0,92	GN 1/1	> <
714590	60	40	1	1,17		> <
714595	65	53	1	1,93		> <

ALUMINIUM PERFORATED PASTRY SHEET

Aluminium

GOBEL

Ref.					
615530	30	40	1	0,37	8/10
615580	53	32,5	1	0,54	8/10
615590	60	40	1	0,73	8/10

ALUMINIUM FLAT PERFORATED PASTRY SHEET

Aluminium

GOBEL

Ref.					
615535	30	40	0,1	0,38	8/10





GOBEL®

BAKING TOOLS

MIXING BOWLS	272
BAKING MATS AND ROLLING PINS	273
WHISKS, SPATULAS, SPOONS AND BRUSHES	275
PASTRY PIPING BAGS AND TUBES	278
WHIPPED CREAM DISPENSERS AND CHARGERS	283
DOUGH CUTTER & SCRAPER	284
PASTRY CUTTER	286
SIEVE AND HOLE SHAKER, DOSING TOOLS AND TINNED SIEVE	289
OTHER TOOLS	293

MIXING BOWL WITH NON-SLIP BOTTOM

Silicone bottom for a better grip on the work surface.

Stainless steel and silicone

GOBEL

Réf.				
GL303	16	10,3	0,2	
GL20P004	20	12	0,28	20 cm
GL20P005	24	14	0,4	24 cm

MIXING BOWL WITH BASE-LID

Graduated. Non-slip base is also a lid!

4 L

Made in France grey base-lid

Stainless steel, TPR

GOBEL

Réf.			
GL20P003	24	15	0,7

MIXING BOWL - ROUND BOTTOM

Stainless steel

GOBEL

Réf.			
GL312	10	0,21	16
GL313	12	0,32	20
GL329	0,4	24	
GL314	17,5	0,9	30
GL315	24,5	1,55	40

FLAT BOTTOM BOWL

Stainless steel

GOBEL

Réf.			
GL316	8,5	0,21	16
GL317	10	0,33	20
GL318	11	0,5	24
GL319	12,5	0,61	28
GL320	14,5	0,71	32

GRADUATED MEASURE

With handle and pouring spout. Graduated in cl and pt.

Stainless steel

0,10 l



Réf.				
NS007	15,5	14	0,24	1 L

BAKING MAT

For cooking and preparation. Non-slip, non-stick.

Platinum silicone-coated glass fiber

-40°C + 260°C / -40°F +500°F

BEST SELLER



LOUIS TELLIER

Ref.				
NCS011	31	52	0,13	
NCS301		30	40	0,12
NCS601	38,5	58,5	0,19	

BAKING MAT - GOBEL

For cooking and preparation. Non-slip and non-stick.

Platinum silicone-coated glass fiber

NEW

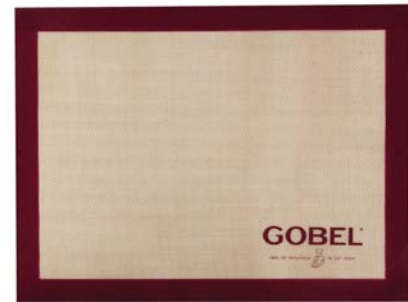

GOBEL

Ref.			
GL304	40	30	0,11
GL305	58	38,5	0,21
GL306	51,5	31	0,15

ST/ST ROLLING PIN

Useful width: 25 cm. Heavy, professional quality.

Stainless steel



LOUIS TELLIER

Ref.			
N3720	6,5	1,8	With oval handles

BEECHWOOD ROLLING PIN

Solid wood. PEFC certified.

Beechwood - PEFC



GOBEL

Ref.			
NRP43	5	0,5	43 cm
NRP47	5	0,6	47 cm
NRP50	5	0,75	50 cm

BEECHWOOD ROLLING PIN - GOBEL

Ideal for Retail store. Solid wood.

Beechwood



GOBEL

Ref.		
GB20P009	5	45 cm - With sleeve packaging

HDPE ROLLING PIN

Hygienic, easy cleaning.

HDPE



LOUIS TELLIER

Ref.			
NRPP45	5	0,64	45 cm
NRPP50	5	0,7	50 cm

PROFESSIONAL WHISK



Unbreakable, untwistable stainless steel wires. Highly resistant to pulling (tested to over 80 kg)

The curved* shape of the handle enables washing liquid to **be passed** and **drained** from between the wires

Whisk-rest collar

Completely and totally watertight* (compliant with the hygiene requirements of the supervisory authorities). Full overmoulding of the handle.

Microtactile insulating handle* that is pleasant to the touch. Suitable for contact with food.

Octagonal* upward-splayed shape for **maximum grip**: anti-fatigue and anti-tightness

This professional whisk is light, balanced, and easy to use. It meets all hygiene and cleaning requirements. The ergonomic, watertight handle offers comfortable use and endurance. Durable: adapted to intensive use.

*All those characteristics are covered by a patent application.

PROFESSIONAL WHISK

Patented, dishwasher safe. Non-slip waterproof handle. Light, balanced and easy to grip.

8 wires

Stainless steel wire



GOBEL

Réf.	Length	Width	Weight	Length
NC070	25	6	0,09	25 cm
NC071	30	8	0,11	30 cm
NC072	35	8	0,18	35 cm
NC073	40	9	0,2	40 cm
NC074	45	10	0,24	45 cm
NC075	50	11	0,26	50 cm

BALLOON WHISK FOR EGG WHITE

Patented, dishwasher safe. Non-slip waterproof handle. Balloon whisk.

8 wires

Stainless steel wire



GOBEL

Réf.	Length	Width	Weight	Length
NC076	35	10	0,2	35 cm
NC077	45	12	0,22	45 cm

SILICONE SPOON-SPATULA

The « PASSION » range of spatulas, in gourmet colors, for cooking lovers !

Silicone



GOBEL

Réf.	Length	Width	Height	Weight
GL19P013	27,5	6	1,4	0,08

SILICONE LARGE SPATULA

The « PASSION » range of spatulas, in gourmet colors, for cooking lovers !

Silicone



GOBEL

Réf.	Length	Width	Height	Weight
GL19P014	27,5	5,5	1,4	0,07

SILICONE SMALL SPATULA

The « PASSION » range of spatulas, in gourmet colors, for cooking lovers !

Silicone



GOBEL

Réf.	Length	Width	Height	Weight
GL19P015	26,5	4	1,4	0,06

SILICON BASTING BRUSH

The « PASSION » range of spatulas, in gourmet colors, for cooking lovers !

Silicone



GOBEL

Réf.	Length	Width	Height	Weight
GL19P016	27,5	5,5	1,4	0,08





CURVED SOLID SPATULA - GOBEL

PEFC certified.

 Beechwood



GOBEL

Réf.				
GL307	30	7	0,5	0,03





CURVED PERFORATED SPATULA - GOBEL

PEFC certified.

 Beechwood



GOBEL

Réf.				
GL308	30	6,7	0,5	0,04





CURVED SLOTTED SPATULA - GOBEL

PEFC certified.

 Beechwood



GOBEL

Réf.				
GL309	30	6,8	0,5	0,04





BEVELLED SPATULA - GOBEL

PEFC certified.

 Beechwood



GOBEL

Réf.				
GL328	35	5	0,7	0,03





ROUNDED SPATULA - GOBEL

PEFC certified.

 Beechwood



GOBEL

Réf.				
GL327	35	4,6	0,6	0,03





SPOON - GOBEL

PEFC certified.

 Beechwood



GOBEL





Réf.				
GL326	35	4,8	1,5	0,05

PAIR OF SALAD SERVERS - GOBEL

PEFC certified.

 Beechwood

GOBEL





Réf.				
GL311	25,5	5,8	1,2	0,05

WOODEN TOAST TONGS - GOBEL

PEFC certified.

 Beechwood

GOBEL



Réf.				
GL310	24	2,5	1,5	0,02

FLAT PASTRY BRUSH

4 sizes.

 Wooden handle, natural silk, st/st ferrule



GOBEL

Réf.			
317020	22,5	0,02	Bristles 25 mm
317030	23,5	0,03	Bristles 35 mm
317040	24,5	0,04	Bristles 40 mm
317050	25,5	0,06	Bristles 50 mm

SILK BRUSH WOODEN HANDLE

Bristles : 50 mm. Soft natural silk bristles.



 Beechwood, st/st ferrule, natural bristle brush

Réf.			
NP20-1	20,5	0,07	20 mm.
NP25-1	21,5	0,09	25 mm.
NP30-1	22,5	0,11	30 mm
NP35-1	23	0,17	35 mm
NP40-1	23,5	0,14	40 mm

SILICONE BRUSH

Easy cleaning. Heat resistant up to 230°C.

 Silicone, stainless steel handle

Réf.		
NPS22	22	0,1

ICING TIP «MOKA»

Stainless steel



GOBEL

Réf.			
815310	0,5	0,01	6 prongs

FILLING TUBES

Tube: 40 mm. Beveled tip.

Stainless steel



GOBEL

Réf.			
815410	0,8	0,07	
815420	0,8	0,09	

ICING TIP «HAZELNUT»

Stainless steel



GOBEL

Réf.			
815510	0,6	0,01	6 prongs

ICING TIP «YULE-LOG»

Stainless steel



GOBEL

Réf.			
815610	2	0,01	8 prongs

ICING TIP «PETITS-FOURS»

Stainless steel



GOBEL

Réf.			
815810	0,6	0,01	8 prongs

ICING TIP «PLAIN» 1 MM

Stainless steel



GOBEL

Réf.			
815210	0,1	0,01	∅ 1 mm

ICING TIP «PLAIN» 8 MM

Stainless steel



GOBEL

Réf.			
815220	0,8	0,01	∅ 8 mm

ICING TIP «PLAIN» 14 MM

Stainless steel



GOBEL

Réf.			
815230	0,14	0,01	∅ 14 mm

ICING TIP «SAINT HONORE»

Stainless steel



GOBEL

Réf.	
815850	0,01

CRYSTAL BOX SET OF 6 PCS ICING TIPS

6 assorted stainless steel icing tips : plain 1 mm - plain 8 mm - moka - hazelnut - yule-log - petits-fours

Stainless steel



GOBEL

Réf.				
888002	13	7	8,5	0,09

BOX SET OF 6 TRITAN PASTRY ICING TIPS

Dim. (n°) PF10 - PF14 - Nest - 8 branches star - Saint-Honoré - Leaf n°2

Tritan



GOBEL

Réf.	
308730	0,07

NATURAL PIPING BAG

Very flexible and easy to handle.

Food grade cotton



GOBEL

Réf.		
313110	25	0,02
313120	30	0,02
313130	35	0,03
313140	40	0,03
313160	50	0,04

PIPING BAG - COATED COTTON

 Coated cotton



GOBEL

Réf.	
GL321	30
GL322	35
GL323	40
GL324	45
GL325	50

CHOUX PASTRY SET

Included: 1 plain icing tip 8 mm + 1 short filling tip + 1 nylon piping bag 400 mm + recipes

 Stainless and nylon



GOBEL

Réf.	
889030	0,06

ROUNDED BOX SET OF 6 ST/ST ICING TIPS + NYLON PIPING BAG

6 assorted stainless steel icing tips + 1 nylon piping bag (300 mm)

 Stainless steel and nylon



GOBEL

Réf.			
889052	12	4	0,11





CRYSTAL BOX SET OF 6 ST/ST ICING TIPS + NYLON PIPING BAG

6 assorted stainless steel icing tips + 1 nylon piping bag (300 mm)

 Stainless steel and nylon



GOBEL

Réf.				
889251	13	7	8,5	0,09





DECORATING SET

6 assorted stainless steel icing tips + 1 nylon piping bag (300 mm)

 Stainless steel and ticking



GOBEL

Réf.				
889210	31,5	14,5	4	0,12



ST/ST CRYSTAL BOX SET OF 6 PCS ICING TIPS ASSORTED + COTTON PIPING BAG

6 assorted stainless steel icing tips + 1 cotton piping bag (300 mm - unbleached cloth)

 Stainless steel and ticking



GOBEL

Réf.				
889151	13	7	8,5	0,11

ROUNDED BOX SET OF 6 ST/ST ICING TIPS + COTTON PIPING BAG

6 assorted stainless steel icing tips + 1 cotton piping bag (300 mm - unbleached cloth)

Stainless steel and ticking



GOBEL



Réf.			
889002	12	4	0,11

DECORATING SET

6 assorted stainless steel icing tips + 1 cotton piping bag (250 mm - unbleached cloth)

Stainless steel and ticking



GOBEL



Réf.				
889101	31,5	14,5	4	0,12

SEMI-PROFESSIONAL WHIPPED CREAM DISPENSER - KAYSER

KAYSER



For hot preparations,
maximum 70 °C

Dishwasher-safe

For Chantilly cream, hot and
cold sauces and emulsions, as
well as sweet and savoury items

Made in the **EU**

They are essential creativity tools for chefs and caterers, and also a way to create nice effect at a lower cost: little raw material is needed to make hundreds of verrines.

Useful for dishes from the entire menu: mises en bouche, verrines, starters, side dishes, sauces, creams, mousses, etc., based on foie gras, seafood, vegetables, and infused cream.

All the parts of the head can be removed for optimum hygiene.

KAYSER SEMI-PRO CREAM WHIPPER

For whipped cream and cold sauces and mousses. The tank is dishwasher safe. All parts of the head are hand wash recommended.

 Stainless steel tank, aluminium head

 + 1°C to +30°C / +33.8°F to +86°F



KAYSER

Réf.			
N4083X	31	0,65	0,5 L
N4084X	35	0,8	1 L

KAYSER PROFESSIONAL CREAM WHIPPER





For hot, cold, savoury or sweet creative espumas. All parts of the tank and head are dishwasher safe.

 Stainless steel

 + 1°C to +70°C / +33.8°F to +158°F



KAYSER







Réf.			
N4086X	31	0,75	0,5 L
N4087X	 35	1	1 L

KAYSER CREAM WHIPPER CHARGERS

 Recyclable steel



KAYSER

Réf.				
NK001	 0,18	0,18	0,65	x50
NK002	 0,18	0,18	0,65	x24
NK003	 2	2	6,5	x10

DOUGH CUTTER

To cut regular strips of dough in one go. Adjustable width. Locked position by a wing nut.

Stainless steel



Réf.	Weight	Wheels
N3703	0,52	6 wheels
N37031	0,52	5 wheels
N37032	0,52	7 wheels

ST/ST DOUGH SCRAPER

Cutting quality. Blade : 15 cm.

Stainless steel



Réf.	Length	Width	Height	Weight	Material
N3725	15	12	3	0,16	Graduated rigid blade

ST/ST DOUGH SCRAPER - PP HANDLE

St/st blade, plastic handle. Professional quality.

PP handle, stainless steel blade



Réf.	Length	Width	Height	Weight	Material
N3730	12,4	11	1,5	0,07	Soft blade
N3731	12,4	11	1,5	0,88	Rigid blade

ST/ST DOUGH SCRAPER - PP HANDLE - SOFT BLADE

St/st blade, plastic handle. Professional quality.

PP handle, stainless steel blade



Réf.	Length	Width	Height	Weight	Material
N3738	11,5	11	3	0,66	Soft blade

RIGID SCRAPER - WHITE

To scrape the bottom of a bowl or bowl and recover all the material or transfer a preparation from one container to another.

PP



Réf.	Length	Width	Weight	Material
317910	12	9	0,02	White - Rigid

SUPPLE SCRAPER - RED

To scrape the bottom of a bowl or bowl and recover all the material or transfer a preparation from one container to another. Also allows you to cut dough pieces.

PP







Réf.	Length	Width	Weight	Material
317920	16	12	0,02	Red - Flexible

SPIKED ROLLER

Prime quality and high productivity. Ergonomic.

 ABS





Ref.				
N3726	22	10	7,5	0,22

ST/ST PIE CRIMPER

Fluted finish. To crimp the edges of a pie.

 Stainless steel



Ref.		
PAP3	9,5	0,3







CROISSANT CUTTER

 Stainless steel



GOBEL



Ref.						
896330	10	6,5	9	0,16	Croissant cutter - small	
896350		20	10	9	0,24	Croissant cutter - large





CROISSANT ROLLER CUTTER

Regular dough triangles : roll over, it's cut !

 Stainless steel, wooden handle



LOUIS TELLIER

Ref.					
N3728	34	8	0,3		Mini-croissant
N3728-2	44	9,5	0,44		Croissant

ROUND FLUTED PASTRY CUTTER - ROLLED EDGES

For a clean cut of any type of dough (puff pastry, shortbread, biscuits, etc.).

Stainless steel

GOBEL

Réf.	∅	I	📦	🔍
844910	3	3,6	0,01	Fluted
844920	4	3,6	0,02	Fluted
844930	5	3,6	0,02	Fluted
844940	6	3,6	0,02	Fluted
844950	7	3,6	0,03	Fluted
844960	8	3,6	0,03	Fluted
844970	9	3,6	0,04	Fluted
844980	10	3,6	0,05	Fluted

PLAIN ROUND PASTRY CUTTER - ROLLED EDGES

For a clean cut of any type of dough (puff pastry, shortbread, biscuits, etc.).

Stainless steel

GOBEL

Réf.	∅	I	📦	🔍
845010	3	3,6	0,01	Plain
845020	4	3,6	0,02	Plain
845030	5	3,6	0,02	Plain
845040	6	3,6	0,02	Plain
845050	7	3,6	0,03	Plain
845060	8	3,6	0,03	Plain
845070	9	3,6	0,04	Plain
845080	10	3,6	0,04	Plain
845090	11	3,6	0,05	Plain

BOX SET OF 8 PCS ROUND FLUTED CUTTER WITH ROLLED EDGES

Stainless steel

GOBEL

Réf.	∅	I	📦	🔍
880001	3 -> 10	4	0,25	Box set of 8 fluted pastry cutters

BOX SET OF 8 PCS PLAIN ROUND CUTTER WITH ROLLED EDGES

Stainless steel

GOBEL

Réf.	∅	I	📦	🔍
880101	3 -> 11	4	0,25	Box set of 8 plain pastry cutters

BOXES AND SETS OF PASTRY CUTTERS

5 cutters : 4,3 x 4,3 x 6,5 cm - 5,7 x 5,7 x 7 cm - 7 x 7 x 7,5 cm - 8 x 8 x 8 cm - 9,2 x 9,2 x 8,5 cm.

Handle

Stainless steel



Réf.	📦	🔍
887902	0,23	Starshaped

PASTRY CUTTER WITH HANDLE

Stainless steel

GOBEL

Réf.	∅	I	📦	🔍
845130	22	4,2	0,28	Epiphany cake
845140	24	4,2	0,3	Epiphany cake
845150	26	4,2	0,32	Epiphany cake
845160	28	4,2	0,34	Epiphany cake

PASTRY CUTTER WITH HANDLE - APPLE TURNOVER

Stainless steel

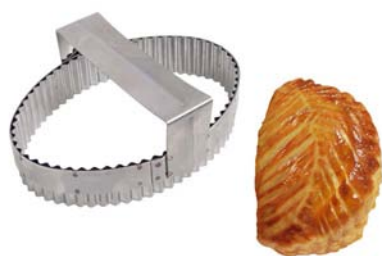

GOBEL

Réf.					
845170	17	12	0,6	0,2	Apple turnover

PASTRY CUTTER WITH HANDLE

Stainless steel



GOBEL

Réf.					
845180	11	11	9,5	0,23	Windmill

PASTRY CUTTER WITH HANDLE FOR BROWNIES - 40 PCS
25 X 25 MM - 200 X 125 X 95

For 42 pieces (25 x 25 mm).

Stainless steel



GOBEL

Réf.				
845200	20	12,5	9,5	0,7

PASTRY CUTTER - CALISSON

Stainless steel



GOBEL

Réf.					
884042	4,5	2,8	3	0,02	
884043		5,3	5,3	3	0,02
884201	7	3,8	4	0,03	
884202	8,3	4,7	4	0,04	

CAKE CUTTERS

To cut 6 equal parts at once.

Stainless steel



GOBEL

Réf.			
N3716	25,5	0,33	6 wedges

3 MESH SCREEN

FRANCE 1897
GOBEL
 rien ne remplace le fait main

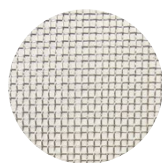

No.16



No.20

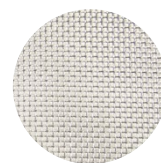

No.25

3 meshes **available**:
 No.16, 20, 25

Inox



Removable sieve with
interchangeable cloths

Must have
 in pastry making



Optimal mesh tension in both parts of
 the sieve thanks to the **fixing system**

Hygiene

This 3-piece stainless steel sieve is hygienic and easy to use.

Mesh No.25 (mesh size 0.9 mm) is a fine grid for icing sugar, flour or cocoa.

Mesh No.20 (mesh size 1.1 mm) is a medium grid for almond or hazelnut powder.

Mesh No.16 (mesh size 1.4 mm) is a wide grid for filtering sauces, coulis, jellies, sieving purees or preparations for espuma.

3 MESHES FLOUR SIEVES

3 meshes: #25 fine, #20 medium and #16 coarse. Removable and interchangeable mesh. For domestic use.

Stainless steel



Réf.		
NC5062860	20	0,46

FLOUR SIEVE 1 PIECE

#20 Medium mesh. The mesh screen is perfectly taut, its border sturdily tucked into the sifter frame.

Stainless steel



Réf.			
NC014	20	0,25	Ø 20 cm
NC015		30	0,27 Ø 30 cm

SIEVE 3 PIECES

Interchangeable mesh and optimum tension.

Stainless steel



Réf.					
NC012		30	1		#20 Medium mesh
NC5060760		30	1		#25 Fine mesh
NC5064660		40	1,18		#20 Medium mesh
NC5064760		40	6	1,2	#25 Fine mesh

REPLACEMENT MESH INSERT

Stainless steel



Réf.				
NC013	30	0,02	#20 Medium mesh	NC012
NC5061760	30	0,24	#25 Fine mesh	NC5060760
NC5065660	40	0,32	#20 Medium mesh	NC5064660
NC5065760	40	0,38	#25 Fine mesh	NC5064760

HOLE SHAKER - MESH

Ideal for icing sugar or cocoa powder. Transparent cap.

Stainless steel



Réf.					
N3705		7	9,5	0,12	Mesh

HOLE SHAKER - 2 MM

Ideal for icing sugar or cocoa powder. Transparent cap.

Stainless steel



Réf.				
N3707	7	9,5	0,12	Ø 2 mm

STAINLESS STEEL FINE TINNED SIEVE

FRANCE 1887
GOBEL
 rien ne remplace le fait main



Cloth cone of fine woven
 304-grade **stainless-steel**,
 opening: 0.45 x 0.45 mm

Highly robust: a **double seams** fixes
 the cloth solidly to the body

Riveted unit

Deep strainer

The hook, the brace,
 and the handle form
 a **single piece**

Gobel's fine tinned sieve is the essential professional tool for filtering all preparations (bouillons, coulis, emulsions, soups, sauces...) and obtaining an ideal texture without residue.

A wooden food masher is available to facilitate the passage of the preparations.

FLOUR SIFTER

Stainless steel



Ref.			
N3711	10,5	14,5	0,22

GRADUATED MEASURE

With handle and pouring spout. Graduated in cl and pt.

Stainless steel

0,10 l



Ref.				
NS008	18	20	0,39	2 L.

MEASURING CUP

5 scales: liquids, flour, sugar, semolina, and starch.

250 ml

PP



Ref.	
DO1250	0,04

FINE STRAINER - TIN PLATED

Allows you to filter sauces, soups, syrups, etc.

Tinplate



GOBEL



Ref.					
114010		20	22	0,38	Without reinforcement - without hook

FINE STRAINER - WITH HOOK - TIN PLATED

Allows you to filter sauces, soups, syrups, etc.

Tinplate



GOBEL



Ref.			
114110	20	22	0,4

FINE STRAINER - WITH REINFORCEMENT AND HOOK - TIN PLATED

Allows you to filter sauces, soups, syrups, etc.

Tinplate



GOBEL



Ref.				
114410	20	26,5	0,56	With reinforcement - with hook

FINE STRAINER - WITH REINFORCEMENT AND HOOK - ST/ST

With stainless steel reinforcement and hook - stainless steel body and tail

 Stainless steel



GOBEL



Ref.		
814410	20	0,55

ST/ST STRAINER STAND

Suitable for Ø 20 cm conical strainers.

 Stainless steel wire



Ref.			
N3020	18	28	0,3



WOODEN FOOD MASHER FOR STRAINER

PEFC certified.

 Beechwood



GOBEL

Ref.		
317310	3,74	0,46

ST/ST ABS CULINARY TORCH

Refillable. Blocking button. Continuous mode and adjustable intensity.

- Removable base
- Stainless steel, ABS



GOBEL

Ref.				
N3924	12,5	12,5	17	0,33

PROFESSIONAL CULINARY TORCH

Gas torch. Ignition button, dimmer and safety catch. To grill, caramelize, melt ...

- Steel, nylon fiber



GOBEL

Ref.					
GL19P011	13	6,5	6,5	0,16	Gas bottle not included

ST/ST ROUND WOVEN CAKE COOLERS

To cool tarts and cookies at the oven exit: suppress moisture to prevent from softening. Ideal for coating, icing, spray or drain.

- Stainless steel



Ref.			
NC007	24	0,1	Ø 24 mm

ROUND WOVEN CAKE COOLERS

To cool tarts and cookies at the oven exit: suppress moisture to prevent from softening. Ideal for coating, icing, spray or drain.

- Stainless steel



Ref.				
NC008	28	2,5	0,1	Ø 28 mm
NC009	32		0,18	Ø 32 mm
NC027	20		0,1	Ø 20 mm
NC028	36	3,5	0,26	Ø 36 mm

SQUARED WOVEN CAKE COOLER

Suitable for tart moulds and square & rectangular cake moulds. Ideal for coating, icing, spray or drain.

- Stainless steel

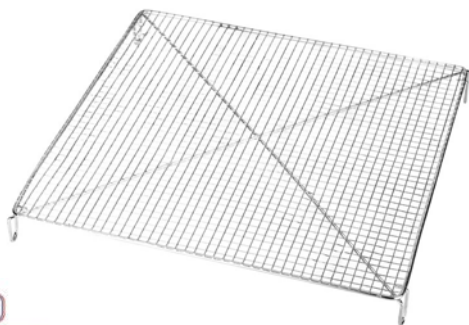

Ref.				
NC1053860	26	26	0,18	Square

RECTANGULAR WOVEN CAKE COOLER FOR TART

Suitable for tart moulds and square & rectangular cake moulds. Ideal for coating, icing, spray or drain.

- Stainless steel

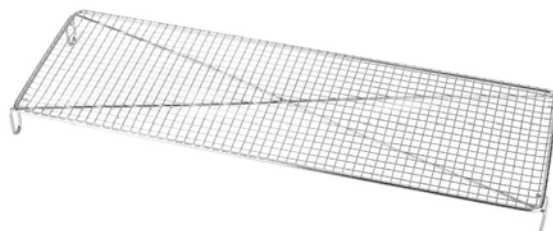

Ref.				
NC1053960	36	12	0,13	Rectangular

STAINLESS STEEL RECTANGULAR WOVEN CAKE COOLER

Suitable for tart moulds and square & rectangular cake moulds. Ideal for coating, icing, spray or drain.

Stainless steel

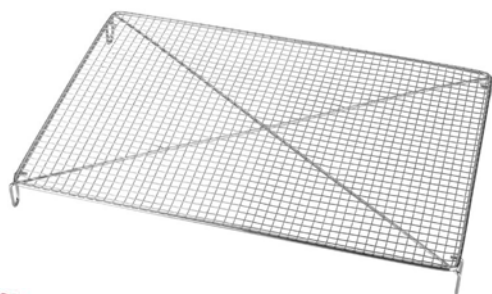

Ref.				
NC1054060	30,5	22	0,16	Rectangular

ST/ST AUTOMATIC FUNNEL

Easy filling of moulds, cavities and glasses with liquids (fondant, chocolate, coulis, cream, sauces). 3 nozzles for different consistencies. Portion control by thumb-action. Leaktight while closed.

1,3 L

With stand, 3 nozzles

Stainless steel



Ref.			
N3715	18,5	0,97	16 cm cone

CHOCOLATE FORKS

To grasp, wrap and transform round, rectangular or square chocolates decoration. You can twist it if necessary.

Stainless steel, ABS handle



Ref.						
ID5000			0,12	Set of 4 models		
ID5001		18	2	2	0,25	Round
ID5002		20	3	2	0,24	Spiral
ID5003		19	2	1,5	0,22	2 tines
ID5004					0,25	3 tines

IMPERIA COOKIE PRESS

Measuring device: to share out the compound precisely. Gun handle: can be operated with one hand.

0,3L

4 dispenser plus 14 dies

Aluminium



Ref.		
N7919	5	0,7

EASY BAKE RELEASE SPRAY

Without taste or smell. Based on rapeseed oil. Ideal for all types of mold, plate, baking mat and cooking equipment (pan, planchas, griddle ...) without the risk of oil splashing.

250 ml

Vegetable oil

220°C



GOBEL

Ref.			
GL19P017	5,3	23,5	0,31

PIE WEIGHT CHAIN

Ideal for baking tart bases blind and stopping the pastry from puffing up.

Stainless steel



Ref.				
NC5020760	10,5	11,5	1,5	0,03

AUTOMATIC PISTON FUNNEL



The automatic piston funnel makes it easier to fill moulds, cavities and glasses with liquids (fondant, chocolate, syrup, coulis, cream, runny batters, sauces).

It comes with 1 stand and 3 tips (for different consistency preparations).



FRANCE 1887
GOBEL
 rien ne remplace le fait main
ORIGINE

MATÉRIAU 100% BIODÉGRADABLE
 Moule en papier naturel
 Compostable à la maison*

DÉMOULAGE FACILE ET RAPIDE
 • Sans matière grasse, démoulage parfait
 • Qualité professionnelle
 • Le moule naturel utilisé en boulangerie
 enfin accessible au grand public

EXCELLENT CONDUCTEUR DE CHALEUR
 • Cuisson parfaite et homogène
 • Montée de la chaleur rapide, jusqu'à 220°C
 * Moule tarte et tartelette

LE CONSEIL DU CHEF
 Idéal pour vos événements (pique-nique, anniversaire...)
 pour des recettes sucrées et salées!

UTILISATION
 • Usage unique
 • Cuisson au four et au micro-onde
 • Réfrigérateur et congélateur
 • Éviter l'humidité

LOUIS TELLIER
www.louistellier.fr
 Distribué par Louis Tellier



FRANCE 1887
GOBEL
 rien ne remplace le fait main

PAPIER J
ORIG
 " LA PRA

DÉMOULAGE FACILE ET RAPIDE
 • Sans matière grasse, démoulage parfait
 • Revêtement antiadhérent bi-couche, qualité professionnelle

TRÈS BONNE DIFFUSION DE LA CHALEUR
 • Cuisson impeccable et uniforme
 • Bonne conduction par son matériau d'acier* revêtu d'antiadhérent

RÉSISTE AUX TEMPÉRATURES ÉLEVÉES
 • Température de chauffe allant jusqu'à 250°C
 *Matériau en alu revêtu d'antiadhérent possible pour certain moule.

LE CONSEIL DU CHEF
 Pour conserver un antiadhérent de qualité, éviter les rayures. Ainsi privilégier une découpe de la préparation en dehors du moule.

ENTRETIEN
 • Nettoyer avant la 1^{ère} utilisation
 • Ne pas passer au lave-vaisselle
 • Laver à l'eau savonneuse



L'ANTIADHÉRE
 " LA FACILITÉ "



LOUIS TELLIER
www.louistellier.fr
 Gobel une marque du Groupe Louis Tellier

LOUIS TELLIER
www.louistellier.fr
 Gobel une marque du Groupe Louis Tellier

Après nettoyage au lave-vaisselle, éviter les produits abrasifs

DISPLAY AND SALES SUPPORT



DISPLAY, CDU, RECIPE REFILL AND POSTER 298

EMPTY CDU FOR PASTÉS DE NATA

Offered for setting up 24 pastés de nata moulds.

 Cardboard



GOBEL

Ref.				
307138	26	20	36	196517

EMPTY CDU FOR CANELE BORDELAIS MOULDS

Offered for setting up 24 Bordeaux canelés, all models combined.

 Cardboard



GOBEL

Ref.					
307130	26	20	36	0,28	729510 / 729520 / 729530

EMPTY CDU FOR SINGLE SERVING CAKES

Offered for setting up 24 individual cake moulds.

 Cardboard



GOBEL

Ref.				
307140	26	20	36	307140

EMPTY CDU FOR DOUGH PUSHERS

Offered for setting up 12 dough pushers.

 Wood and cardboard



GOBEL

Ref.			
307131	16,5	1	319110

12-CUP BARQUETTE PAN CDU

Contact your representative.



GOBEL

Ref.			
307132	17	17	298410

CDU WITH HOME MADE BREAD RECIPES

Contact your representative.

 Cardboard



GOBEL

Ref.			
307136	17	17	234010 / 223690 / 134000 / 123690

«MINI-BURGER» CDU

Contact your representative.

Cardboard

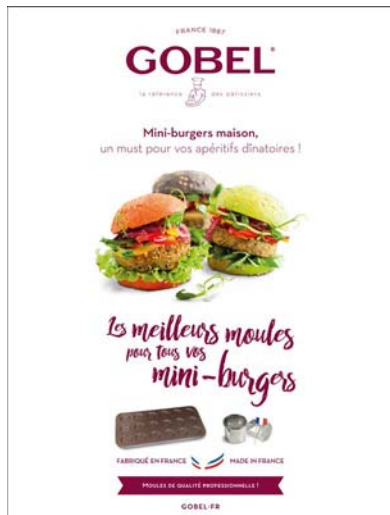

Réf.	↔	↙
307146	40	30

RECIPES REFILL - 50 PC

Paper



Réf.	🔍	📄
305253	Caneles bordelais	307130
305255	Pastéis de nata	307138
305256	Boat-shaped mould	307132
305257	Brioche	307139
305258	Mini cakes	307140
305254		307136

MERCHANDISING CLIP - OBSIDIAN

PP



Réf.	↔	↙	⊥	📦
GL19P010	5,5	3,5	1	0,01

«Z» MOULD SUPPORT

Stainless steel



Réf.	↔	↙	⊥	📦
813710	22	15,5	6	0,24

POSTER « LA CUISINE »

Individual cardboard roll

Glossy paper



Réf.	↔	↙	📦	🔍
PB1	30	44,5	0,06	S
PB2	63	90,5	0,08	L

The dimensions ↔ ↙ ⊥ ∅ are expressed in cm, the weight 📦 in kg.
www.louistellier.fr

Category	Ref.	Designation	
RACLETTE APPLIANCES			
BREZ	BREZ-B-12	Black operation knob - set of 12	BREZ01 / BREZ01C / BREZ02 / BREZ02C / BREZ03 / BREZ04 / BREZ01BA / BREZ01NX
	BREZ-RDRG	Heating resistances (left & right)	BREZ01 / BREZ01C / BREZ02 / BREZ02C / BREZ03 / BREZ04 / BREZ01BA / BREZ01NX
	BREZ01-S	St/st cheese holder	BREZ01 / BREZ01C / BREZ02 / BREZ02C / BREZ03 / BREZ04 / BREZ01BA / BREZ01NX
	5005	Power cable - US / BREZ02 / BREZ02C / RACL02 / RACL02C	BREZ02 / BREZ02C / RACL02 / RACL02C
	5007	Power cable 230v	BREZ01C / BREZ01BA / BREZ01NX
	5010	Power cable - UK / BREZ03 / RACL03	BREZ03
	5004	Power cable - CH / BREZ04	BREZ04
	5032	Switch - except BREZ02 / BREZ02C	BREZ01 / BREZ01C / BREZ01BA / BREZ01NX / BREZ03 / BREZ04
	BREZ05-P	Wooden handle	BREZ01NX
	CAR01	Raclette knife	BREZ01 / BREZ01C / BREZ02 / BREZ02C / BREZ03 / BREZ04 / BREZ01BA / BREZ01NX
RACL	5005	Power cable - US / BREZ02 / BREZ02C / RACL02 / RACL02C	BREZ02 / BREZ02C
	5007	Power cable 230v	RACPN01X / RACL01 / RACL01BA / RACL01NX
	5010	Power cable - UK / BREZ03 / RACL03	RACL03
	5012-5	Operation knob - set of 5	RACL01 / RACL02 / RACL02C / RACL03 / RACL01BA / RACL01NX
	5006	Heating resistance	RACL01 / RACL02 / RACL02C / RACL03 / RACL01BA / RACL01NX
	5019	Cheese holder + black handle	RACL01 / RACL02 / RACL02C / RACL03 / RACL01BA / RACL01NX
	5020-5	Black handle - set of 5	RACL01 / RACL02 / RACL02C / RACL03 / RACL01BA / RACL01NX
	5018	Rack	RACL01 / RACL02 / RACL02C / RACL03 / RACL01BA / RACL01NX
	5001-10	Attachment pin - set of 10	RACL01 / RACL02 / RACL02C / RACL03 / RACL01BA / RACL01NX
	5027	Wooden handle / RACL01NX	RACL01NX
	CAR01	Raclette knife	RACL01 / RACL02 / RACL02C / RACL03 / RACL01BA / RACL01NX
	5021	Left slide cheese holder	RACL01 / RACL02 / RACL02C / RACL03 / RACL01BA / RACL01NX
	5023	Right slide cheese holder	RACL01 / RACL02 / RACL02C / RACL03 / RACL01BA / RACL01NX
	5033	Set of 4 frying pans	RACPN01X
	5007	Power cable	RACPN01X
	5034	Heating resistance	RACPN01X
	5035	Upper plate	RACPN01X
5037	Lower plate - frying pan support	RACPN01X	
TTM RACLETTE APPLIANCES...(SE)			
TTM	BRU01-2	Alcohol burner - set of 2	TTM03 / TTM80AL
	TTM05BC	Complete housing 230v / TTM05	TTM05
	TTM05R	Resistance 230 v / TTM05	TTM05
	TTM05E	Plate of base (without button) / TTM05	TTM05 / TTM05C-110
	TTM05B	Black button to screw / TTM	TTM05 / TTM10 / TTM20 / TTM05C-110 / TTM10C-110 / TTM20C-110
	TTM05BA	Hinged arm / TTM05	TTM05 / TTM05C-110
	TTM05PF	Cheese-holder	TTM05 / TTM05C-110
	TTM05COR	Cord 230v / TTM05	TTM05
	TTM10BC	Complete housing 230v / TTM10 / TTM20	TTM10 / TTM20 / TTM30
	TTM10R	Resistance 230v / TTM10 / TTM20 / TTM30	TTM10 / TTM20
	TTM10-INT	Switch on - off / TTM10 / TTM20	TTM10 / TTM20 / TTM10C-110 / TTM20C-110
	TTM10SF	Cheese lighting device	TTM10 / TTM20 / TTM10C-110 / TTM20C-110
	TTM10P	Rubber handle	TTM10 / TTM20 / TTM10C-110 / TTM20C-110
	TTM10COR	Cord 230 v	TTM10 / TTM20
	TTM30SF	Cheese lighting device TTM30	TTM30
	TTM30VIS-MPF	Assembling screw cheese holder	TTM30
	TTM30TF	Long central screw TTM30	TTM30
	TTM30-BTTF	Knob for long central screw	TTM30
	TTM30T	Thermostat / TTM30	TTM30
	TTM40CER	Resistance 230v / TTM40CE	TTM40CE
	TTM40CEP	Saucepan / TTM40CE	TTM40CE
	TTM80EB	Electric base 230 v / TTM80E	TTM80E
	TTM80ECH	Hat only / TTM80E	TTM80E
	TTM80ECP	Saucepan / TTM80e / lozeng, wood handle	TTM80E
	TTM80ES	Circular chromed-steel support / TTM80E	TTM80E

Category	Ref.	Designation		
TOMATO SAUCE MILL (SE)				
CT3X CT3X-EL	CT3-M	Handle / CT3X	CT3X/CT3X-EL	
	CT3-OPTHV5	Meat mincer option / CT3X / CT3X-EL	CT3X/CT3X-EL	
	CT3-PI-M	Transmission pivot / CT3X-EL	CT3X	
	CT3-VIS	Plastic propeller / CT3X / CT3X-EL	CT3X-CT3X-EL	
	CT3X-CME	Cover + gears for motor / CT3X	CT3X	
	CT3X-CORPS	Cast iron casing / CT3X-EL	CT3X	
	CT3X-E	St / steel funnel / CT3X	CT3X	
	CT3X-EG	St / steel gutter / CT3X	CT3X	
	CT3X-ELPC	Cone protection against projection / CT3X-EL	CT3X-EL	
	CT3X-ELCORPS	Cast iron casing / CT3X-EL	CT3X-EL	
	CT3X-ELJ	Funnel seal / CT3X-EL	CT3X-EL	
	CT3X-F	St / steel filtering cone / CT3X, standard	CT3X	
	CT3X-FS	St / steel filtering cone / CT3X, special for red fruits	CT3X	
	CT3X-FSG	St / steel filtering cone / CT3X, holes 2,5 mm	CT3X	
	CT3X-PAT	Clamp foot / CT3X	CT3X	
	CT3X-PIE	Transmission pivot / CT3X-EL	CT3X-EL	
	ELECTRONIC SCALES			
N3697	N3697-PLT	Stainless steel pan	N3697	
	N3697-S	Plastic support for st / st pan	N3697	
	N3697-PP	Front display overlay + protection sheet	N3697	
	N3697-CS	Top cover	N3697	
	N3697-PCB	Pcb card + lcd screen	N3697	
	N3697-CAP	Load cell	N3697	
	N3697-J	Sealing joint	N3697	
	N3697-B	Rechargeable battery	N3697	
	N3697-CP	Battery box cover	N3697	
	N3697-A	Power adapter	N3697	
N3697-PI4	Set of 4 foot	N3697		
N3670 N3671 N3672	N3670-PLTX	Stainless steel upper tray / N3670 / N3671 / N3672 / N3673	N3670/N3671/N3672/N3673	
	N3670-P	Plastic tray / N3670 / N3671 / N3672 / N3673	N3670	
	N3670-PP	Front panel / N3670	N3670	
	N3671-PP	Front panel / N3671	N3671	
	N3672-PP	Front panel / N3672	N3672	
	N3673-PP	Front panel / N3673	N3673	
	N3671-PK	Keyboard / N3670 / N3671 / N3672 / N3673	N3670/N3671/N3672/N3673	
	N3670-CAP	Load cell / N3670	N3670	
	N3671-CAP	Load cell / N3671	N3671	
	N3672-CAP	Load cell / N3672	N3672	
	N3673-CAP	Load cell / N3673	N3673	
	N3670-PCB	Pcb card + lcd screen / N3670	N3670	
	N3671-PCB	Pcb card + lcd screen / N3671	N3671	
	N3672-PCB	Pcb card + lcd screen / N3672	N3672	
	N3673-PCB	Pcb card + lcd screen / N3673	N3673	
	N3670-CP	Battery cover / N3670 / N3671 / N3672 / N3673	N3670/N3671/N3672/N3673	
	N3670-PI4	Set of 4 foot / N3670 / N3671 / N3672 / N3673	N3670/N3671/N3672/N3673	
	N3670-A	Power adaptor 6v 2a / N3670 / N3671 / N3672 / N3673	N3670/N3671/N3672/N3673	
	N3693 N3694	N3694-PLT	Stainless steel upper tray / N3693 / N3694	N3693/N3694
		N3694-P	Plastic tray / N3693 / N3694	N3693/N3694
N3693-CP		Battery box cover / N3693 / N3694	N3693	
N3693-PP		Front panel / N3693	N3693	
N3694-PP		Front panel / N3694	N3694	
N3693-PI4		Set of 4 foot / N3693 / N3694	N3693/N3694	
N3693-CAP		Load cell / N3693	N3693	
N3694-CAP		Load cell / N3694	N3694	
N3693-PCB		Pcb + lcd display / N3693	N3693	
N3694-PCB		Pcb + lcd display / N3694	N3694	
N3693-A	Power adaptor	N3693/N3694		

Category	Ref.	Designation	
N3681 N3682	N3681-PLTX	Stainless steel pan / N3681 / N3682	N3681/N3682
	N3681-JS	Silicone gasket - set of 4 / N3681/ N3682	N3681/N3682
	N3682-PP	Front panel / N3682	N3682
	N3681-PP	Front panel / N3681	N3681
	N3681-PI4	Set of 4 foot / N3681 / N3682	N3681/N3682
N3684 N3685 N3686	N3684-BAT	Rechargeable battery / N3684/ N3685/ N3686	N3684/N3685/N3686
	N3684-FUS	Fuse / N3684 / N3685 / N3686	N3684/N3685/N3686
	N3684-PCB	Pcb card (without screen) / N3684	N3684
	N3685-PCB	Pcb card (without screen) / N3685	N3685
	N3686-PCB	Pcb card (without screen) / N3686	N3686
	N3684-PP	Front panel / N3684 / N3685 / N3686	N3684/N3685/N3686
	N3684-PK	Keyboard / N3684 / N3685 / N3686	N3684/N3685/N3686
	N3684-COR	Power cord 230v / N3684 / N3685 / N3686	N3684/N3685/N3686
	N3685-9	T connector / N3684 / N3685 / N3686	N3684/N3685/N3686
	N3684-C	Column / N3684 / N3685	N3684/N3685
	N3685-E	Lcd screen / N3684 / N3685 / N3686	N3684/N3685/N3686
	N3684-B	Complete indicator box / N3684	N3684
	N3685-B	Complete indicator box / N3685	N3685
	N3686-B	Complete indicator box / N3686	N3686
	N3686-C	Column / N3686	N3686
	N3684-P	Stainless steel tray / N3684 / N3685	N3684/N3685
	N3686-P	Stainless steel tray / N3686	N3686
	N3684-CAP	Load cell / N3684	N3684
	N3685-CAP	Load cell / N3685	N3685
	N3686-CAP	Load cell / N3686	N3686
	N3684-PI4	Set of 4 foot / N3684 / N3685 / N3686	N3684/N3685/N3686

TABLE BBQ / BRASERO

BRAS	GRIL-BRX	Grid for brasero	BRAS01 / BRASI-O / BRASI-F
	BRAS01-F	Steel fireplace	BRAS01 / BRASI-O / BRASI-F
	BRAS01-PC	Ashtray / BRAS01	BRAS01
	BRAS-POI	Carrying handle / fireplace for brasero	BRAS01 / BRASI-O / BRASI-F
	CEND-BRX	Ashtray / BRASI-F & BRASI-O	BRASI-O / BRASI-F
	SOLE-BRX	Hearth bottom / BRASI-F & BRASI-O	BRASI-O / BRASI-F

ELECTRIC JUICE EXTRACTOR (SE)

CEN426	CEN-BROS	Brush / CEN426	CEN426
	CEN-C	Condenser / CEN426	CEN426
	CEN-E	Driver / CEN426	CEN426
	CEN-ES	Special nut for driver / CEN426	CEN426
	CEN-I	Switch on - off / CEN426	CEN426
	CEN-R	Tip for driver nut / CEN426	CEN426
	CEN422B	Pulp container / CEN426	CEN426
	CEN422F	Filter / CEN426	CEN426
	CEN422R	Juice container / CEN426	CEN426
	CEN426BM	Grey complete motot base / CEN426 (round bow)	CEN426
	CEN426BOL	Juice jug / CEN426	CEN426
	CEN426C	Cover / CEN426	CEN426
	CEN426CA	Skull cap / CEN426	CEN426
	CEN426P	Push block / CEN426	CEN426
	CEN426TI	Bow (fixation handle) / CEN426	CEN426

CHOCOLATE MAKER

N4905	N4905-P21PP	Plastic lid	N4905
	N4905-P28-1	Plastic lid top of the faucet	N4905
	N4905-P22	Paddle plastic mixer	N4905
	N4905-P22-1	Plastic mixer base	N4905
	N4905-P23	Bowl shaft	N4905
	N4905-JA	Bowl shaft o-ring	N4905
	N4905-P25	Bowl steel plate	N4905
	N4905-P26	Central shaft nut	N4905
	N4905-JC	Bowl gasket	N4905
	N4905-P	Faucet piston	N4905

Category	Ref.	Designation	
N4905	N4905-JR	Faucet piston o-ring	N4905
	N4905-L	Faucet handle	N4905
	N4905-R	Faucet spring	N4905
	N4905-GR	Faucet handle pin	N4905
	N4905-P33	Plastic bowl only	N4905
	N4905-TC	Bowl o-ring	N4905
	N4905-P18	Drip tray	N4905
	N4905-P17	Drip tray cover	N4905
	N4905-C	Plastic bowl with faucet	N4905
	N4905-P1	Drinving shaft	N4905
	N4905-P39	Teflon tube	N4905
	N4905-P38	Central shaft	N4905
	N4905-P2	Heating plate holder	N4905
	N4905-P4	Thermocontact	N4905
	N4905-P5	Spring	N4905
	N4905-P6	Heating element	N4905
	N4905-P7	Limit switch	N4905
	N4905-P36	Gear motor flange	N4905
	N4905-M	Motor 230v 50hz	N4905
	N4905-P10	Cabinate	N4905
	N4905-P12	Switch	N4905
	N4905-P40	Thermostat knob	N4905
	N4905-P13	Thermostat 0° - 90° C	N4905
	N4905-TH2	Thermostat 0° - 120° C	N4905
	N4905-P15	Base	N4905
	N4905-P16	Rubber feet	N4905
	N4905-P41	Black thermostat knob	N4905
	N4905-P20	Connection box	N4905
N4905-P19	Strain relief	N4905	
N4905-P21SS	St/st lid	N4905	

STICKS CUTTER

CC08 CC10	CF308	Stainless steel blade 8 x 8 mm	CC08 / CC10
	CF310	Stainless steel blade 10 x 10 mm	CC08 / CC10
	CC208.	Pusher 8 x 8 mm for CC	CC08 / CC10
	CC210.	Pusher 10 x 10 mm for CC	CC08 / CC10
	CAX020	St/st long feet - set of 3	CC08 / CC10
	GX016-12	Suction + suction ring - set of 12	CC08 / CC10
	CAX023-10CC	Spring for column CC - set of 10	CC08 / CC10
	CCGP5	Pin for pusher - set of 5	CC08 / CC10
	CF0005X-2	St/st spring with cog wheel - set of 2	CC08 / CC10
	CF0006	Rod (without screw)	CC08 / CC10

CITRUS SLICER 1/2 & 1/4 SLICES

CDX	CAX017	Carriage support with handles - without plastic disc cap	CDX4 / CDX7 / CDX40 / CDX70 / CDX47
	CAX018	Low support without handle	CDX4 / CDX7 / CDX40 / CDX70 / CDX47
	GX016-12	Suction + suction ring - set of 12	CDX4 / CDX7 / CDX40 / CDX70 / CDX47
	CAX019	St/st column - set of 2	CDX4 / CDX7 / CDX40 / CDX70 / CDX47
	CAX021	Short nylon feet - set of 3	CDX4 / CDX7 / CDX40 / CDX70 / CDX47
	CDX004	Blade block - 5 blades (12 mm)	CDX4 / CDX7 / CDX40 / CDX70 / CDX47
	CDX007	Blade block - 8 blades (6 mm)	CDX4 / CDX7 / CDX40 / CDX70 / CDX47
	CDX40	Blade block - 5 blades (12 mm) with carriage support & handles	CDX4 / CDX7 / CDX40 / CDX70 / CDX47
	CDX70	Blade block - 8 blades (6 mm) with carriage support & handles	CDX4 / CDX7 / CDX40 / CDX70 / CDX47

FILM DISTRIBUTOR

DFV300 DFV450	GX016-12	Suction + suction ring - set of 12	DFV300 / DFV450
	GX017-4	St/st short feet - set of 4	DFV300 / DFV451
	DF030	Food Film Cutter 30 cm / DFV300	DFV300
	DF045	Food Film Cutter 45 cm / DFV450	DFV450
	DF300T	Central rod / DFV300	DFV300
	DF450T	Central rod / DFV450	DFV450

Category	Ref.	Designation		
PROFESSIONAL FRENCH FRY CUTTER				
CX	CF306	St/st blade 6 x 6 mm	CX00 / CX06 / CX08 / CX10 / CX13	
	CF308	St/st blade 8 x 8 mm	CX00 / CX06 / CX08 / CX10 / CX13	
	CF310	St/st blade 10 x 10 mm	CX00 / CX06 / CX08 / CX10 / CX13	
	CF313	St/st blade 13 x 13 mm	CX00 / CX06 / CX08 / CX10 / CX13	
	CF206	Pusher 6 x 6 mm for french fry cutter	CX00 / CX06 / CX08 / CX10 / CX13	
	CF208	Pusher 8 x 8 mm for french fry cutter	CX00 / CX06 / CX08 / CX10 / CX13	
	CF210	Pusher 10 x 10 mm / 10 x 20 mm / 20 x 20 mm for french fry cutter	CX00 / CX06 / CX08 / CX10 / CX13	
	CF213	Pusher 13 x 13 mm for french fry cutter	CX00 / CX06 / CX08 / CX10 / CX13	
	C006X	Kit pusher + st / st blade 6 x 6 mm	CX00 / CX06 / CX08 / CX10 / CX13	
	C008X	Kit pusher + st / st blade 8 x 8 mm	CX00 / CX06 / CX08 / CX10 / CX13	
	C010X	Kit pusher + st / st blade 10 x 10 mm	CX00 / CX06 / CX08 / CX10 / CX13	
	C013X	Kit pusher + st / st blade 13 x 13 mm	CX00 / CX06 / CX08 / CX10 / CX13	
	CF0005X-2	St/st spring with cog wheel - set of 2	CX00 / CX06 / CX08 / CX10 / CX13	
	CF0007	Plastic carriage	CX00 / CX06 / CX08 / CX10 / CX13	
	CF0018-3	Set of 9 rubber feet for table stand	CX00 / CX06 / CX08 / CX10 / CX13	
	CX020	St/st table stand without rubber feet	CX00 / CX06 / CX08 / CX10 / CX13	
	CF0003	Black bowl/handle for lever	CX00 / CX06 / CX08 / CX10 / CX13	
	CF0004	Chipper frame + spring with cog wheel	CX00 / CX06 / CX08 / CX10 / CX13	
	CF0006	Rod (without screw)	CX00 / CX06 / CX08 / CX10 / CX13	
	CX-P	CF306	St/st blade 6 x 6 mm	CX00-P / CX06-P / CX08-P / CX10-P / CX13-P
		CF308	St/st blade 8 x 8 mm	CX00-P / CX06-P / CX08-P / CX10-P / CX13-P
		CF310	St/st blade 10 x 10 mm	CX00-P / CX06-P / CX08-P / CX10-P / CX13-P
		CF313	St/st blade 13 x 13 mm	CX00-P / CX06-P / CX08-P / CX10-P / CX13-P
		CF206	Pusher 6 x 6 mm for french fry cutter	CX00-P / CX06-P / CX08-P / CX10-P / CX13-P
		CF208	Pusher 8 x 8 mm for french fry cutter	CX00-P / CX06-P / CX08-P / CX10-P / CX13-P
		CF210	Pusher 10 x 10 mm / 10 x 20 mm / 20 x 20 mm for french fry cutter	CX00-P / CX06-P / CX08-P / CX10-P / CX13-P
CF213		Pusher 13 x 13 mm for french fry cutter	CX00-P / CX06-P / CX08-P / CX10-P / CX13-P	
C006X		Kit pusher + st/st blade 6 x 6 mm	CX00-P / CX06-P / CX08-P / CX10-P / CX13-P	
C008X		Kit pusher + st/st blade 8 x 8 mm	CX00-P / CX06-P / CX08-P / CX10-P / CX13-P	
C010X		Kit pusher + st/st blade 10 x 10 mm	CX00-P / CX06-P / CX08-P / CX10-P / CX13-P	
C013X		Kit pusher + st/st blade 13 x 13 mm	CX00-P / CX06-P / CX08-P / CX10-P / CX13-P	
CF0005X-2		St/st spring with cog wheel - set of 2	CX00-P / CX06-P / CX08-P / CX10-P / CX13-P	
CF0007		Plastic carriage	CX00-P / CX06-P / CX08-P / CX10-P / CX13-P	
GX017-4		St/st short feet - set of 4	CX00-P / CX06-P / CX08-P / CX10-P / CX13-P	
GX016-12		Suction + suction ring - set of 12	CX00-P / CX06-P / CX08-P / CX10-P / CX13-P	
CF0006		Rod (without screw)	CX00-P / CX06-P / CX08-P / CX10-P / CX13-P	
CF0004		Chipper frame + spring with cog wheel	CX00-P / CX06-P / CX08-P / CX10-P / CX13-P	
CF0003		Black bowl/handle for lever	CX00-P / CX06-P / CX08-P / CX10-P / CX13-P	
CS		CF106	Blade 6 x 6 mm - tinned	CS00 / CS06 / CS08 / CS10 / CS13
		CF108	Blade 8 x 8 mm - tinned	CS00 / CS06 / CS08 / CS10 / CS13
		CF110	Blade 10 x 10 mm - tinned	CS00 / CS06 / CS08 / CS10 / CS13
		CF113	Blade 13 x 13 mm - tinned	CS00 / CS06 / CS08 / CS10 / CS13
		CF120	Blade 10 x 20 mm - tinned	CS00 / CS06 / CS08 / CS10 / CS13
		CF122	Blade 20 x 20 mm - tinned	CS00 / CS06 / CS08 / CS10 / CS13
		CF1K	Blade 6 wedges - tinned	CS00 / CS06 / CS08 / CS10 / CS13
	CF206	Pusher 6 x 6 mm for french fry cutter	CS00 / CS06 / CS08 / CS10 / CS13	
	CF208	Pusher 8 x 8 mm for french fry cutter	CS00 / CS06 / CS08 / CS10 / CS13	
	CF210	Pusher 10 x 10 mm / 10 x 20 mm / 20 x 20 mm for french fry cutter	CS00 / CS06 / CS08 / CS10 / CS13	
	CF213	Pusher 13 x 13 mm for french fry cutter	CS00 / CS06 / CS08 / CS10 / CS13	
	CF2K	Pusher 6 wedges	CS00 / CS06 / CS08 / CS10 / CS13	
	C006	Kit pusher + tin blade 6 x 6 mm	CS00 / CS06 / CS08 / CS10 / CS13	
	C008	Kit pusher + tin blade 8 x 8 mm	CS00 / CS06 / CS08 / CS10 / CS13	
	C010	Kit pusher + tin blade 10 x 10 mm	CS00 / CS06 / CS08 / CS10 / CS13	
	C013	Kit pusher + tin blade 13 x 13 mm	CS00 / CS06 / CS08 / CS10 / CS13	
	C020	Kit pusher + tin blade 10 x 20 mm	CS00 / CS06 / CS08 / CS10 / CS13	
	C022	Kit pusher + tin blade 20 x 20 mm	CS00 / CS06 / CS08 / CS10 / CS13	
	C00K	Kit pusher + tin blade 6 wedges	CS00 / CS06 / CS08 / CS10 / CS13	
	CF0005-2	Spring with cog wheel - set of 2	CS00 / CS06 / CS08 / CS10 / CS13	
	CF0007	Plastic carriage	CS00 / CS06 / CS08 / CS10 / CS13	
	CF0018-3	Set of 9 rubber feet for table stand	CS00 / CS06 / CS08 / CS10 / CS13	
	CF0009	Epoxy stand without rubber feet	CS00 / CS06 / CS08 / CS10 / CS13	
	CF0008	Epoxy stand without rubber feet - export model	CS00 / CS06 / CS08 / CS10 / CS13	

Category	Ref.	Designation	
CS	CF0004	Chipper frame + spring with cog wheel	CS00 / CS06 / CS08 / CS10 / CS13
	CF0006	Rod (without screw)	CS00 / CS06 / CS08 / CS10 / CS13
	CF0003	Black bowl/handle for lever	CS00 / CS06 / CS08 / CS10 / CS13
	CF0016	Table stand fixation screw kit	CS00 / CS06 / CS08 / CS10 / CS13
CP	CF106	Blade 6 x 6 mm - tinned	CP00 / CP06 / CP08 / CP10 / CP13
	CF108	Blade 8 x 8 mm - tinned	CP00 / CP06 / CP08 / CP10 / CP13
	CF110	Blade 10 x 10 mm - tinned	CP00 / CP06 / CP08 / CP10 / CP13
	CF113	Blade 13 x 13 mm - tinned	CP00 / CP06 / CP08 / CP10 / CP13
	CF120	Blade 10 x 20 mm - tinned	CP00 / CP06 / CP08 / CP10 / CP13
	CF122	Blade 20 x 20 mm - tinned	CP00 / CP06 / CP08 / CP10 / CP13
	CF1K	Blade 6 wedges - tinned	CP00 / CP06 / CP08 / CP10 / CP13
	CF206	Pusher 6 x 6 mm for french fry cutter	CP00 / CP06 / CP08 / CP10 / CP13
	CF208	Pusher 8 x 8 mm for french fry cutter	CP00 / CP06 / CP08 / CP10 / CP13
	CF210	Pusher 10 x 10 mm / 10 x 20 mm / 20 x 20 mm for french fry cutter	CP00 / CP06 / CP08 / CP10 / CP13
	CF213	Pusher 13 x 13 mm for french fry cutter	CP00 / CP06 / CP08 / CP10 / CP13
	CF2K	Pusher 6 wedges	CP00 / CP06 / CP08 / CP10 / CP13
	C006	Kit pusher + tin blade 6 x 6 mm	CP00 / CP06 / CP08 / CP10 / CP13
	C008	Kit pusher + tin blade 8 x 8 mm	CP00 / CP06 / CP08 / CP10 / CP13
C010	Kit pusher + tin blade 10 x 10 mm	CP00 / CP06 / CP08 / CP10 / CP13	
C013	Kit pusher + tin blade 13 x 13 mm	CP00 / CP06 / CP08 / CP10 / CP13	
C020	Kit pusher + tin blade 10 x 20 mm	CP00 / CP06 / CP08 / CP10 / CP13	
C022	Kit pusher + tin blade 20 x 20 mm	CP00 / CP06 / CP08 / CP10 / CP13	
C00K	Kit pusher + tin blade 6 wedges	CP00 / CP06 / CP08 / CP10 / CP13	
CF0005-2	Spring with cog wheel - set of 2	CP00 / CP06 / CP08 / CP10 / CP13	
CF0007	Plastic carriage	CP00 / CP06 / CP08 / CP10 / CP13	
CF0010	Tripod stand	CP00 / CP06 / CP08 / CP10 / CP13	
C00	CF0004	Chipper frame + spring with cog wheel	CP00 / CP06 / CP08 / CP10 / CP13
	CF0006	Rod (without screw)	CP00 / CP06 / CP08 / CP10 / CP13
	CF0003	Black bowl / handle for lever	CP00 / CP06 / CP08 / CP10 / CP13
	CF106	Blade 6 x 6 mm - tinned	C00 / C06 / C08 / C10 / C13
	CF108	Blade 8 x 8 mm - tinned	C00 / C06 / C08 / C10 / C13
	CF110	Blade 10 x 10 mm - tinned	C00 / C06 / C08 / C10 / C13
	CF113	Blade 13 x 13 mm - tinned	C00 / C06 / C08 / C10 / C13
	CF120	Blade 10 x 20 mm - tinned	C00 / C06 / C08 / C10 / C13
	CF122	Blade 20 x 20 mm - tinned	C00 / C06 / C08 / C10 / C13
	CF1K	Blade 6 wedges - tinned	C00 / C06 / C08 / C10 / C13
	CF206	Pusher 6 x 6 mm for french fry cutter	C00 / C06 / C08 / C10 / C13
	CF208	Pusher 8 x 8 mm for french fry cutter	C00 / C06 / C08 / C10 / C13
	CF210	Pusher 10 x 10 mm / 10 x 20 mm / 20 x 20 mm for french fry cutter	C00 / C06 / C08 / C10 / C13
	CF213	Pusher 13 x 13 mm for french fry cutter	C00 / C06 / C08 / C10 / C13
CF2K	Pusher 6 wedges	C00 / C06 / C08 / C10 / C13	
C006	Kit pusher + tin blade 6 x 6 mm	C00 / C06 / C08 / C10 / C13	
C008	kit pusher + tin blade 8 x 8 mm	C00 / C06 / C08 / C10 / C13	
C010	kit pusher + tin blade 10 x 10 mm	C00 / C06 / C08 / C10 / C13	
C013	kit pusher + tin blade 13 x 13 mm	C00 / C06 / C08 / C10 / C13	
C020	kit pusher + tin blade 10 x 20 mm	C00 / C06 / C08 / C10 / C13	
C022	kit pusher + tin blade 20 x 20 mm	C00 / C06 / C08 / C10 / C13	
C00K	Kit pusher + tin blade 6 wedges	C00 / C06 / C08 / C10 / C13	
CF0005-2	Spring with cog wheel - set of 2	C00 / C06 / C08 / C10 / C13	
CF0007	Plastic carriage	C00 / C06 / C08 / C10 / C13	
CM	CF0004	Chipper frame + spring with cog wheel	C00 / C06 / C08 / C10 / C13
	CF0006	Rod (without screw)	C00 / C06 / C08 / C10 / C13
	CF0003	Black bowl/handle for lever	C00 / C06 / C08 / C10 / C13
	CF106	Blade 6 x 6 mm - tinned	CM00 / CM06 / CM08 / CM10 / CM13
	CF108	Blade 8 x 8 mm - tinned	CM00 / CM06 / CM08 / CM10 / CM13
	CF110	Blade 10 x 10 mm - tinned	CM00 / CM06 / CM08 / CM10 / CM13
	CF113	Blade 13 x 13 mm - tinned	CM00 / CM06 / CM08 / CM10 / CM13
	CF120	Blade 10 x 20 mm - tinned	CM00 / CM06 / CM08 / CM10 / CM13
	CF122	Blade 20 x 20 mm - tinned	CM00 / CM06 / CM08 / CM10 / CM13
	CF1K	Blade 6 wedges - tinned	CM00 / CM06 / CM08 / CM10 / CM13
	CF206	Pusher 6 x 6 mm for french fry cutter	CM00 / CM06 / CM08 / CM10 / CM13
	CF208	Pusher 8 x 8 mm for french fry cutter	CM00 / CM06 / CM08 / CM10 / CM13
	CF210	Pusher 10 x 10 mm / 10 x 20 mm / 20 x 20 mm for french fry cutter	CM00 / CM06 / CM08 / CM10 / CM13
	CF213	Pusher 13 x 13 mm for french fry cutter	CM00 / CM06 / CM08 / CM10 / CM13

Category	Ref.	Designation		
CM	CF2K	Pusher 6 wedges	CM00 / CM06 / CM08 / CM10 / CM13	
	C006	Kit pusher + tin blade 6 x 6 mm	CM00 / CM06 / CM08 / CM10 / CM13	
	C008	Kit pusher + tin blade 8 x 8 mm	CM00 / CM06 / CM08 / CM10 / CM13	
	C010	it pusher + tin blade 10 x 10 mm	CM00 / CM06 / CM08 / CM10 / CM13	
	C013	Kit pusher + tin blade 13 x 13 mm	CM00 / CM06 / CM08 / CM10 / CM13	
	C020	Kit pusher + tin blade 10 x 20 mm	CM00 / CM06 / CM08 / CM10 / CM13	
	C022	Kit pusher + tin blade 20 x 20 mm	CM00 / CM06 / CM08 / CM10 / CM13	
	C00K	Kit pusher + tin blade 6 wedges	CM00 / CM06 / CM08 / CM10 / CM13	
	CF0005-2	Spring with cog wheel - set of 2	CM00 / CM06 / CM08 / CM10 / CM13	
	CF0007	Plastic carriage	CM00 / CM06 / CM08 / CM10 / CM13	
	CF0011	Wall stand fixation	CM00 / CM06 / CM08 / CM10 / CM13	
	CF0004	Chipper frame + spring with cog wheel	CM00 / CM06 / CM08 / CM10 / CM13	
	CF0006	Rod (without screw)	CM00 / CM06 / CM08 / CM10 / CM13	
	CF0003	Black bowl/handle for lever	CM00 / CM06 / CM08 / CM10 / CM13	
	CSP10	VLT12	Set of 12 suction base feet	CSP10
		LT20A009	Kit blade & pusher 10 x 10 mm	CSP10
		LT20A010	Plastic carriage	CSP10
LT20S001		Blade holder + 2 knurled clamping screws	CSP10	
CFPN	CF310	St/st blade 10 x 10 mm	CFPN10/CFPN08	
	CF308	St/st blade 8 x 8 mm	CFPN10/CFPN08	
	CC210.	Pusher 10 x 10 mm / CC	CFPN10/CFPN08	
	CC208.	Pusher 8 x 8 mm / CC	CFPN10/CFPN08	

STRIP CUTTER

CLAN	4051-1	Handle (round axle)	CLANX / CLANX-05
	8010	Training axis	CLANX / CLANX-05
	8005	Training axis - long shape for soft vegetable	CLANX / CLANX-05
	8001	Cutting unit 1 mm	CLANX / CLANX-05
	8002	Cutting unit 1,5 mm	CLANX / CLANX-05
	8003	Cutting unit 2,3 mm	CLANX / CLANX-05
	VLT12	Set of 12 suction base feet	CLANX / CLANX-05
	8009	Centering axis	CLANX / CLANX-05
	8006	Cutting blade 1 mm	CLANX / CLANX-05
	8007	Cutting blade 1,5 mm	CLANX / CLANX-05
	8008	Cutting blade 2,3 mm	CLANX / CLANX-05

JAPANESE STRIP SLICERS (SE)

CLAN	CLAN03-LAP	Straight blade / CLAN03	CLAN03
	CLAN-GRV	1 pawl / CLAN01 / CLAN02 / CLAN03	CLAN01 / CLAN02 / CLAN03
	CLAN-M	Handle / CLAN01 / CLAN02 / CLAN03	CLAN01 / CLAN02 / CLAN03
	CLAN-AXE	Shaft + cap and slide catchers / CLAN02 / CLAN01	CLAN01 / CLAN02
	CLAN-B	White adjustment button / CLAN01 / CLAN02 / CLAN03	CLAN01 / CLAN02 / CLAN03
	CLAN-BAN	Ribbon blade casket / CLAN01 / CLAN02	CLAN01 / CLAN02
	CLAN-BE	Cam ring / CLAN02 / CLAN01	CLAN01 / CLAN02
	CLAN-FI	Net blade casket / CLAN01 / CLAN02	CLAN01 / CLAN02
	CLAN-LAP	Straight blade / CLAN01 / CLAN02 / CLAN04 + 2 screws	CLAN01 / CLAN02 / CLAN04
	CLAN-MAN	Shaft spindle / CLAN01	CLAN01
	CLAN-SPA	Spaghetti blade casket / CLAN01 / CLAN02	CLAN01 / CLAN02
	CLAN-SUP	Blade holder / CLAN01 / CLAN02	CLAN01 / CLAN02
	CLAN-VIS	2 screws for flat blade / CLAN01 / CLAN02 / CLAN03 / CLAN04	CLAN01 / CLAN02 / CLAN03 / CLAN04
	CLAN01-E19A	Metal nut spindle side, green plastic / CLAN01	CLAN01
	CLAN01-E19B	Metal nut shafts stopper side, green plastic / CLAN01	CLAN01
	CLAN01-FLG	Left side cover b / CLAN01	CLAN01
	CLAN01-TI	Axis + tip / CLAN01	CLAN01
	CLAN01-TM	Shaft spindle head / CLAN01	CLAN01
	CLAN01-V18A	Metal spindle side, green plastic / CLAN01	CLAN01
	CLAN01-V18B	Metal shaft stopper side, green plastic / CLAN01	CLAN01
	CLAN02-AXE	Slide pipe / CLAN02 / old model	CLAN02
	CLAN02-B	Spindle / CLAN01 / CLAN02	CLAN02
	CLAN02-BAR	Bearing bar / CLAN02	CLAN02
	CLAN02-E13A	Metal nut spindle side, brown plastic / CLAN02	CLAN02
	CLAN02-E13B	Metal nut shafts stopper side, brown plastic / CLAN02	CLAN02
	CLAN02-ENG	2 gears large and small + clip / CLAN01 / CLAN02	CLAN02
	CLAN02-G	Cross cap / CLAN02 / old model	CLAN02

Category	Ref.	Designation	
CLAN	CLAN02-V12A	Metal spindle side, brown plastic / CLAN02	CLAN02
	CLAN02-V12B	Metal shafts stopper side, brown plastic / CLAN02	CLAN02
	CLAN03-AXE	Complete shaft with pawl [3 PARTS : 14, 15, 16] / CLAN03	CLAN03
	CLAN03-SPA	Spaghetti blade casket / CLAN03	CLAN03

VEGETABLE SLICER (SE)

N2994 N2997	N2994-13.6	Blade + pusher 13.6 mm / N2994	N2994
	N2994-6.8	Blade + pusher 6.8 mm / N2994	N2994
	N2994T6.8	6.8 mm slicer / N2994	N2994
	N2997-06	Blade + pusher 6 mm / N2997	N2997
	N2997-06L	6 mm slicer / N2997	N2997
	N2997-06-P	Cleaning comb 6 mm / N2996 / N2997	N2997
	N2997-09	Blade + pusher 9 mm / N2997	N2997
	N2997-09-P	Cleanin comb 9 mm / N2997	N2997
	N2997-B	Container / N2996 / N2997	N2997
N3011	N3011MX-N	Cleaning grid for mini onion slicer	N3011MX
	N3011X-03-N	Cleaning grid 3x3 mm / N3011X	N3011X
	N3011X-03-P	Pusher 3x3 mm/ N3011X	N3011X
	N3011X-06-N	Cleaning grid 6x6 mm / N3011X (D)	N3011X
	N3011X-09-N	Cleaning grid 9x9 mm for st / st big alligator (D)	N3011X

JAPANESE VEGETABLE SLICER (SE)

4500CLR 3000CLR	4500CLR-L	Straight blade / 4500CLR	4500CLR
	4500CLR-LF	Fine unit blade cuttings / 4500CLR / 3000CLR	4500CLR / 3000CLR
	4500CLR-LL	Coarse unit blade cuttings / 4500CLR / 3000CLR	4500CLR / 3000CLR
	4500CLR-C	Cutting face set / 4500CLR (without flat blade)	4500CLR
	4500CLR-CE	Prop and slide board set / 4500CLR	4500CLR
	4500CLR-E	Prop / 4500CLR	4500CLR
	4500CLR-LM	Medium unit blade cuttings / 4500CLR / 3000CLR	4500CLR / 3000CLR
	4500CLR-RP	Wheel / 4500CLR	4500CLR

MELON WEDGER

SM01	SM006	St/st blade 6 wedges	SM01 / SM06 / SM08
SM06	SM008	St/st blade 8 wedges	SM01 / SM06 / SM08
SM08	SM007	Support base fully equipped (support / st-st wires / columns)	SM01 / SM06 / SM08

BREAD SLICER (ROUND BLADE / STRAIGHT BLADE)

703S	GX017-4	St/st short feet - set of 4	703SF1 / 703SF1P / 703SX
	GX016-12	Suction + suction ring - set of 12	703SF1 / 703SF1P / 703SX
	753CP	Plastic safety device + screw	703SF1 / 703SF1P / 703SX
	723CP	Knurled screw / thickness cutting adjustment	703SF1 / 703SF1P / 703SX
	716CP	Round blade with wood handle	703SF1
	717CP	Round blade with plastic handle	703SF1P / 703SX
	734CP	Slice thickness adjustment stop	703SF1 / 703SF1P / 703SX
	720CP	Wood handle	703SF1
	733CP	Axle	703SF1 / 703SF1P / 703SX
	35CPX	190CL20	Non skid pad / stop - set of 20
35CPX-NP		Plastic safety device	35CPX
35CPX-NL		Blade + handle	35CPX

SALAD CUTTER

CSA CSAL CSAM	CSA01	Assembled blade 23 x 23 mm / CSA	CSA / CSAL
	CSA02	Pusher 23 x 23 mm/ CSA	CSA
	CSAL01	Assembled blade 12 x 100 mm / CSAL	CSAL
	CSAL02	Pusher 12 x 100 mm / CSAL	CSA / CSAL
	CSA05	2 knurled screws	CSA / CSAL
	EA-GP-5	Pin for pusher - set of 5	CSA / CSAL /CSAM
	GX017-4	St/st short feet - set of 4	CSA / CSAL
	GX016-12	Puction + suction ring - set of 12	CSA / CSAL /CSAM
	CSAM01	Blade 25 x 25 mm / CSAM	CSAM
	CSAM02	Pusher 25 x 25 mm / CSAM	CSAM
	CSAM04	2 knurled screws	CSAM
	OE29046	Handle / lever	CSA / CSAL

Category	Ref.	Designation		
TERRINE SLICER				
CTER	GX017-4	St/st short feet - set of 4	CTER01 / CTER02	
	GX016-12	Suction + suction ring - set of 12	CTER01 / CTER02	
	CTER01F	Set of 2 st/st wires / CTER01 / 3,1 m	CTER01	
	CTER02F	Set of 2 st/st wires / CTER02 / 4,2 m	CTER02	
	4062	Support for flat products - 10 mm / CTER	CTER01 / CTER02	
	4063	Support for flat products - 7 mm / CTER	CTER01 / CTER02	
	4064	Cutting set 7 mm / CTER	CTER01 / CTER02	
	4065	Cutting set 10 mm / CTER	CTER01 / CTER02	
	4066-2	Black handle / CTER - set of 2	CTER01 / CTER02	
	4061	Set of 2 springs/ CTER	CTER01 / CTER02	
	4070	Guiding ring - set of 4	CTER01 / CTER02	
TOMATO / CITRUS / APPLE WEDGER				
CAX 104 CAX106 CAX108 CAX112 CAX104P CAX106P CAX108P	CAX004	St/st blade 4 wedges / CAX	CAX104 / CAX104P	
	CAX006	St/st blade 6 wedges / CAX	CAX106 / CAX106P	
	CAX008	St/st blade 8 wedges / CAX	CAX108 / CAX108P	
	CAX012	St/st blade 12 wedges / CAX	CAX112 / CAX212	
	CAX004P	St/st blade 4 wedges / CAX apple corer	CAX104 / CAX104P	
	CAX006P	St/st blade 6 wedges / CAX apple corer	CAX106 / CAX106P	
	CAX008P	St/st blade 8 wedges / CAX apple corer	CAX108 / CAX108P	
	CAX015	Pusher/support 4 / 8 wedges	CAX104 / CAX104P / CAX108P / CAX108	
	CAX016	Pusher/support 6 / 12 wedges	CAX106 / CAX106P / CAX112	
	CAX017	Carriage support with handles - without plastic disc cap	CAX104 / CAX106 / CAX108 / CAX112 / CAX104P / CAX106P / CAX108P	
	CAX018	Low support without handle	CAX104 / CAX106 / CAX108 / CAX112 / CAX104P / CAX106P / CAX108P	
	GX016-12	Suction + suction ring - set of 12	CAX104 / CAX106 / CAX108 / CAX112 / CAX104P / CAX106P / CAX108P	
	CAX019	St/st column - set of 2	CAX104 / CAX106 / CAX108 / CAX112 / CAX104P / CAX106P / CAX108P	
	CAX023-10	Spring for column CAX -set of 10	CAX104 / CAX106 / CAX108 / CAX112 / CAX104P / CAX106P / CAX108P	
	CAX020	St/st long feet - set of 3	CAX104 / CAX108 / CAX112 / CAX104P / CAX106P / CAX108P	
	CAX025-5	Plastic disc cap -set of 5	CAX104 / CAX106 / CAX108 / CAX112 / CAX104P / CAX106P / CAX108P	
	CAX024-20	Stop pusher / CAX - set of 20	CAX104 / CAX106 / CAX108 / CAX112 / CAX104P / CAX106P / CAX108P	
	CAX022	Complete set of screws	CAX104 / CAX106 / CAX108 / CAX112 / CAX104P / CAX106P / CAX108P	
	CAX204 CAX206 CAX208 CAX212	CAX004	St/st blade 4 wedges / CAX	CAX204
		CAX006	St/st blade 6 wedges / CAX	CAX106 / CAX106P
		CAX008	St/st blade 8 wedges / CAX	CAX108 / CAX108P
		CAX012	St/st blade 12 wedges / CAX	CAX212
CAX015		Pusher/support 4 / 8 wedges	CAX204 / CAX208	
CAX016		Pusher/support 6 / 12 wedges	CAX206 / CAX212	
CAX025-5		Plastic disc cap -set of 5	CAX204 / CAX206 / CAX208 / CAX212	
CAX017		Carriage support with handles - without plastic disc cap	CAX204 / CAX206 / CAX208 / CAX212	
CAX018		Low support without handle	CAX204 / CAX206 / CAX208 / CAX212	
GX016-12		Suction + suction ring - set of 12	CAX204 / CAX206 / CAX208 / CAX212	
CAX019		St/st column - set of 2	CAX204 / CAX206 / CAX208 / CAX212	
CAX021		Short nylon feet - set of 3	CAX204 / CAX206 / CAX208 / CAX212	
CAX022		Complete set of screws	CAX204 / CAX206 / CAX208 / CAX212	
TOMATO SLICERS				
CTXM55		GX016-12	Suction + suction ring - set of 12	CTXM55
		GX017-4	St/st short feet - set of 4	CTXM55
	CTXM08	Set of 8 blades	CTXM55	
	CTXM010-10	White ring spacer - set of 10	CTXM55	
	CTXM011-2	2 threaded rods & supports + screw	CTXM55	
	OE29046	Handle / lever	CTXM55	
	CTX019	Handle + axle + screw	CTXM55	
	CTXM07	Black handle + 2 screws	CTXM55	
	CTXM09	usher stainless steel plate	CTXM55	
	CTXM014	HD carriage - white	CTXM55	
	CTXM10	Push arm support	CTXM55	

Category	Ref.	Designation	
CTX	CTX016	Plastic plate for pusher x1 1	CTX
	CTX012M	Set of 11 assembled blades + screws	CTX
	CTX012	Set of 11 blades	CTX
	GX017-4	St/st short feet - set of 4	CTX
	GX016-12	Suction + suction ring - set of 12	CTX
	190CL-20	Non skid pad / stop - set of 20	CTX
	CTX24-2	Security pin - set of 2	CTX
	OE29046	Handle / lever	CTX
	CTX019	Handle + axle + screw	CTX
	CTX22	Kit of 8 screws for blades	CTX
	CTX25	Pusher support (without screw)	CTX
	CTX014	Push arm - without handle - without push plate	CTX
	CTX032-2	Blade axle - set of 2	CTX
	CTX026	Push-on support guide rod x1	CTX
	CTX028	Stainless steel pusher disc spacer	CTX
	CTX20-8	Pierced discs for blades - set of 8	CTX
	CTX21-16	Discs for blades - set of 16	CTX
	CTX031	Blade holder	CTX
	CTX030	St/st stand	CTX
	CTX40	GX017-4	St/st short feet - set of 4
GX016-12		Suction + suction ring - set of 12	CTX40
190CL-20		Non skid pad / stop - set of 20	CTX40
CTX015		Set of 14 blades	CTX40
CTX030		St/st stand	CTX40
CTX25		Pusher support (without screw)	CTX40
CTX026		Push-on support guide rod x1	CTX40
CTX24-2		Security pin - set of 2	CTX40
CTX019		Handle + axle + screw	CTX40
OE29046		Handle / lever	CTX40
CTX027		Stainless steel push plate - perforated	CTX40
CTX014		Push arm - without handle - without push plate	CTX40
CTX029-2	Holding pin blades - set of 2	CTX40	
CT-MZ	GX017-4	St/st short feet - set of 4	CT-MZ
	GX016-12	Suction + suction ring - set of 12	CT-MZ
	190CL-20	Non skid pad / stop - set of 20	CT-MZ
	LT20S006	Set of 11 assembled blades + screws	CT-MZ
	LT20S007	Set of 11 blades	CT-MZ
	LT20S004	Plastic plate for pusher - set of 12 - with screws	CT-MZ
	OE29046	Handle / lever	CT-MZ
	CTX019	Handle + axle + screw	CT-MZ
	CTX030	St/st stand	CT-MZ
	CTX031	Blade holder	CT-MZ
	CTX026	Push-on support guide rod x1	CT-MZ
	CTX24-2	Security pin - set of 2	CT-MZ
	LT20S005	Push arm + handle - without push plate	CT-MZ
	CTX20-8	Pierced discs for blades - set of 8	CT-MZ
	CTX21-16	Discs for blades - set of 16	CT-MZ
	CTX032-2	Blade axle - set of 2	CT-MZ
	CTX22	Kit of 8 screws for blades	CT-MZ
	RICE COOKERS		
N8900	N8900-CU	Removal tank	N8900
	N8900-03	Magnetic thermostat	N8900
	N8900-09	Fuse	N8900
	N8900-10	68°C thermostat	N8900
	N8900-15	Main switch	N8900
	N8900-04	Heating base	N8900
	N8900-06	Heating element - ring	N8900
	N8900-08	Electric switch	N8900

Category	Ref.	Designation	
N8094	N8094-CU	Switch	N8094
	N8094-T	Thermostat	N8094
	N8094-TC	Thermocontact	N8094
	N8094-R	Heating resistance	N8094
	N8094-B	Switch on/off	N8094
	N8094-C	Removable tank - non stick	N8094
	N8094-CO	Lid	N8094
	N8094-HB	Heating base	N8094

MANUAL PINEAPPLE PEELER

EA	EA001	St/st blade Ø 89 mm / EA	EA. / EA95 / EA105
	EA002	Pusher Ø 89 mm / EA	EA. / EA95 / EA105
	EA003	St/st blade Ø 74 mm / EA	EA. / EA95 / EA105
	EA004	Pusher Ø 74 mm / EA	EA. / EA95 / EA105
	EA005	St/st blade Ø 102 mm / EA	EA. / EA95 / EA105
	EA006	Pusher Ø 102 mm / EA	EA. / EA95 / EA105
	EA007	St/st blade Ø 95 mm / EA	EA. / EA95 / EA105
	EA008	Pusher Ø 95 mm / EA	EA. / EA95 / EA105
	EA009	St/st mango blade / EA	EA. / EA95 / EA105
	EA010	Pusher for mango blade / EA	EA. / EA95 / EA105
	EA013	St/st blade 8 wedges / EA	EA. / EA95 / EA105
	EA014	Pusher 8 wedges / EA	EA. / EA95 / EA105
	EA-GP-5	Pin for pusher - set of 5	EA. / EA95 / EA105
	EA35089-2	Blade clamping screw - set of 2	EA. / EA95 / EA105
	GX016-12	Suction + suction ring - set of 12	EA. / EA95 / EA105
	GX017-4	St/st short feet - set of 4	EA. / EA95 / EA105
	EA35060	Set of 2 blade holders pad (front & rear)	EA. / EA95 / EA105
	OE29046	Handle / lever	EA. / EA95 / EA105

ELECTRIC PINEAPPLE PEELER

EA-EL	EA001	St/st blade Ø 89 mm / EA	EA-EL
	EA002	Pusher Ø 89 mm / EA	EA-EL
	EA003	St/st blade Ø 74 mm / EA	EA-EL
	EA004	usher Ø 74 mm / EA	EA-EL
	EA005	St/st blade Ø 102 mm / EA	EA-EL
	EA006	Pusher Ø 102 mm / EA	EA-EL
	EA007	St/st blade Ø 95 mm / EA	EA-EL
	EA008	Pusher Ø 95 mm / EA	EA-EL
	EA009	St/st mango blade / EA	EA-EL
	EA010	Pusher for mango blade / EA	EA-EL
	EA013	St/st blade 8 wedges / EA	EA-EL
	EA014	Pusher 8 wedges / EA	EA-EL
	EA-GP-5	Pin for pusher - set of 5	EA-EL
	EA35089-2	Blade clamping screw - set of 2	EA-EL
	GX016-12	Suction + suction ring - set of 12	EA-EL
	GX017-4	St/st short feet - set of 4	EA-EL
	EA-ELS01	On-off button - set of 2	EA-EL
	EA-ELS02	Complete linear motor	EA-EL
EA-ELS03	Cabled power supply box	EA-EL	
EA-ELS04	Cable distribution	EA-EL	
EA35060	Set of 2 blade holders pad (front & rear)	EA-EL	

PEELERS

EP EPX ESJX EM EMX	E0010.	Carrot peeling head accessory + pusher	EMX001 à EMX004 / EM001 à EM004 / EPX001 à EPX004 / EP001 à EP004 / ESJX001 à ESJX04
	E0011.	Big carrot peeling head accessory + pusher	EMX001 à EMX004 / EM001 à EM004 / EPX001 à EPX004 / EP001 à EP004 / ESJX001 à ESJX05
	E0012.	Cucumber peeling head accessory	EMX001 à EMX004 / EM001 à EM004 / EPX001 à EPX004 / EP001 à EP004 / ESJX001 à ESJX06
	E0015	Epoxy stand	EP001 / EP002 / EP003 / EP004
	EX0015	Stainless steel stand	EPX001 / EPX002 / EPX003 / EPX004
	E0014	Epoxy wall fixation	EM001 / EM002 / EM003 / EM004
	EX0014	Stainless steel wall fixation	EMX001 / EMX002 / EMX003 / EMX004
	PSJX	Stainless steel clamp fixation	ESJX001 / ESJX002 / ESJX003 / ESJX004
	N5121	Carrot blade - set of 6	EMX001 / EM001 / EPX001 / EP001 / ESJX001

Category	Ref.	Designation		
EP EPX ESJX EM EMX	N5122	Cucumber blade - set of 6	EMX003 / EM003 / EPX003 / EP003 / ESJX003	
	N5127	Big carrot blade - set of 6	EMX002 / EM002 / EPX002 / EP002 / ESJX002	
	E0017	Carrot plastic ring	EMX001 / EM001 / EPX001 / EP001 / ESJX001	
	E0018	Big carrot / cucumber plastic ring	EMX002 / EM002 / EPX002 / EP002 / ESJX002	
	E0016.	Pusher for carrot / big carrot	EMX001 / EMX002 / EM001 / EM002 / EPX001 / EPX002 / ESJX001 / ESJX002	
	N5124	Set of 6 springs for carrot / big carrot / cucumber	EMX001 à EMX003 / EM001 à EM003 / EPX001 à EPX003 / EP001 à EP003 / ESJX001 à ESJX003	
	N5140	Short blade support arm / big carrot & cucumber - set of 2	EMX002 / EMX003 / EM002 / EM003 / EPX002 / EPX003 / ESJX002 / ESJX003 / EP002 / EP003	
	N5141	Mid blade support arm / big carrot & cucumber - set of 2	EMX002 / EMX003 / EM002 / EM003 / EPX002 / EPX003 / ESJX002 / ESJX003 / EP002 / EP003	
	N5142	Long blade support arm / big carrot & cucumber - set of 2	EMX002 / EMX003 / EM002 / EM003 / EPX002 / EPX003 / ESJX002 / ESJX003 / EP002 / EP003	
	N5130	Short blade support arm / carrot - set of 2	EMX001 / EM001 / EPX001 / EP001 / ESJX001	
	N5131	Mid blade support arm / carrot - set of 2	EMX001 / EM001 / EPX001 / EP001 / ESJX001	
	N5132	Long blade support arm / carrot - set of 2	EMX001 / EM001 / EPX001 / EP001 / ESJX001	
	E0019.	Asparagus peeling head accessory	EMX001 à EMX004 / EM001 à EM004 / EPX001 à EPX004 / EP001 à EP004 / ESJX001 à ESJX004	
	N5120	Asparagus blade - set of 2	MLT.	
	N5125	Set of 6 springs for asparagus	EMX004 / EM004 / EPX004 / EP004 / ESJX004	
	N5143	Blade support short arm / asparagus - set of 2	EMX004 / EM004 / EPX004 / EP004 / ESJX004	
	N5144	Blade support mid arm / asparagus - set of 2	EMX004 / EM004 / EPX004 / EP004 / ESJX004	
	N5145	Blade support long arm / asparagus - set of 2	EMX004 / EM004 / EPX004 / EP004 / ESJX004	
	E0015	Epoxy stand	EP001 / EP002 / EP003 / EP004	
	EX0015	Stainless steel stand	EPX001 / EPX002 / EPX003 / EPX004	
	PEELERS (SE)			
	N4220 N4221	N4220-B	Arm holder	N4220
		N4220-BC	Cutting arm - complete circular arm	N4220 / N4221
		N4220-CI	Plastic housing / interruptor	N4220
		N4220-COR	Electric cord / N4220 / N4221	N4220 / N4221
		N4220-DI	Two speed interruptor	N4220 / N4221
		N4220-I	Switch on - off red	N4220 / N4221
N4220-PIT		Gear	N4220 / N4221	
N4221-PI		Plastic pin / arm holder - N4221	N4221	
N4220-PL		St/st pin / arm holder - N4220	N4220	
N4225		N4225-M	Handle harm + plastic handle / N4225	N4225
	N4225-MP	Yellow part with shaft for orange peeler	N4225	
BREAD SLICER				
FVX1	F001	St/st blade for sandwiches	FVX1	
	O2898	St/st table stand clamping screw + white cup	FVX1	
	O2879-10	White cup / clamping screw - set of 10	FVX1	
	F003	Pressure spring	FVX1	
SMOKER				
FAF FAFR	FAF01	Heating resistance	FAF/FAFR	
GUITAR				
GX	GX011	Cutting set 5 mm	GX01 / GX02 / GX03 / GX04 / GX05 / GX06	
	GX013	Cutting set 10 mm	GX01 / GX02 / GX03 / GX04 / GX05 / GX06	
	GX051	Cutting set 7 mm	GX01 / GX02 / GX03 / GX04 / GX05 / GX06	
	GX012	Support for round products - 5 mm	GX01 / GX02 / GX03 / GX04 / GX05 / GX06	
	GX014	Support for round products - 10 mm	GX01 / GX02 / GX03 / GX04 / GX05 / GX06	
	GX052	Support for round products - 7 mm	GX01 / GX02 / GX03 / GX04 / GX05 / GX06	
	GX022	Support for flat products - 5 mm	GX01 / GX02 / GX03 / GX04 / GX05 / GX06	
	GX024	Support for flat products - 10 mm	GX01 / GX02 / GX03 / GX04 / GX05 / GX06	
	GX053	Support for flat products - 7 mm	GX01 / GX02 / GX03 / GX04 / GX05 / GX06	
	GX015-2	Set of 8 x 2 st/st wires	GX01 / GX02 / GX03 / GX04 / GX05 / GX06	
	GX017-4	St/st short feet - set of 4	GX01 / GX02 / GX03 / GX04 / GX05 / GX06	
	GX016-12	Suction + suction ring - set of 12	GX01 / GX02 / GX03 / GX04 / GX05 / GX06	
	OE7518	Height screw stop / clamping screw	GX01 / GX02 / GX03 / GX04 / GX05 / GX06	

Category	Ref.	Designation	
GXM	GXM013	Cutting set 10 mm	GXM03 / GXM04 / GXM05 / GXM06
	GXM051	Cutting set 7 mm	GXM03 / GXM04 / GXM05 / GXM06
	GXM012	Support for round products - 10 mm	GXM03 / GXM04 / GXM05 / GXM06
	GXM052	Support for round products - 7 mm	GXM03 / GXM04 / GXM05 / GXM06
	GXM022	Support for flat products - 10 mm	GXM03 / GXM04 / GXM05 / GXM06
	GXM053	Support for flat products - 7 mm	GXM03 / GXM04 / GXM05 / GXM06
	GXM015-2	Set of 4 x 6 st/st wires	GXM03 / GXM04 / GXM05 / GXM06
	GX017-4	St/st short feet - set of 4	GX01 / GX02 / GX03 / GX04 / GX05 / GX06
	GX016-12	Suction + suction ring - set of 12	GX01 / GX02 / GX03 / GX04 / GX05 / GX06
	GXM016-6	Wire tensioner screw - set of 6	GXM03 / GXM04 / GXM05 / GXM06
	OE7518	Height screw stop / clamping screw	GX01 / GX02 / GX03 / GX04 / GX05 / GX06

MEAT MINCERS (SE)

HV5 HV12 HV22 HV12-EL HV5-EL HV22-EL HV22-XEL	HV1222CT5-ENG	Set 3 gears / HV12-EL / HV22-EL / CT5-EL	HV12 / HV22 / CT5
	HV1222J	Gears seal / HV12 / 22-EL	HV12 / HV22
	HV1222-PIL	Pusher pestel / HV12-EL / HV22-EL	HV12 / HV22
	HV1222-PL	Dish / HV12-EL / HV22-EL	HV12 / HV22
	HV1222-SOC	Base / HV12 / HV22-EL / CT5X-EL4	HV12 / HV22
	HV12-C	Blade / HV12-EL	HV12
	HV12-CAP-HEL	Plastic hood (propeller side) / HV12-EL	HV12 / CT5X-EL4
	HV12-CARRE	Endless screw square / HV12-EL	HV12-EL
	HV12-CO	Condenser / HV12-EL	HV12-EL
	HV12-CORPS	Cast iron main / HV12-E	HV12
	HV12-COUR	Plastic crown / HV12-EL	HV12
	HV12-CR	Gear cover + oil seal / HV12-EL / HV22-EL	HV12 / HV22
	HV12-CRJ	Gear bracket seal / HV12-EL / HV22-EL	HV12 / HV22
	HV12-ELM	Enfine alone / HV12-EL	V12-EL
	HV12-ENT15	Sausage funnel 1.5 cm / HV12-EL	HV12
	HV12-ENT25	Sausage funnel 2.5 cm / HV12-EL	HV12
	HV12-G10	Disc 10 mm / HV12-EL	HV12
	HV12-G12	Disc 12 mm / HV12-EL	HV12
	HV12-G14	Disc 10 mm / HV12-EL	HV12
	HV12-G16	Disc 16 mm / HV12-EL	HV12
	HV12-G18	Disc 18 mm / HV12-EL	HV12
	HV12-G20	Disc 20 mm / HV12-EL	HV12
	HV12-G3	Disc 3 mm / HV12-EL	HV12
	HV12-G4.5	Disc 4.5 mm / HV12-EL	HV12
	HV12-G6	Disc 6 mm / HV12-EL	HV12
	HV12-G8	Disc 8 mm / HV12-EL	HV12
	HV12-HEL	Propeller / HV12-EL	HV12
	HV12-INT	Switch on - off / HV12-EL / HV5-EL	HV12-EL / HV5-EL
	HV12-VIR	Ring nut / HV12-EL	HV12-EL
	HV12-VIS	Endless screw / HV12-EL	HV12
	HV22-C	Blade / HV22-EL	HV22
	HV22-CAP-HEL	Plastic hood (propeller side) / HV22-EL	HV22-EL
	HV22-CARRE	Endless screw square / HV22-EL	HV22-EL
	HV22-CO	Engine capacitor / HV22-EL	HV22
	HV22-CORPS	Cast iron main / HV22-EL	HV22
	HV22-COUR	Plastic brown / HV22-EL / HV22-EL / HV22-XEL	HV22-EL / HV22-XEL
	HV22-CX	Blade / HV22-XEL	HV22-XEL
	HV22-ELM	Engine alone / HV22-EL	HV22-EL
	HV22-ENT15	Sausage funnel 1.5 cm / HV22-EL	HV22
	HV22-ENT20	Sausage funnel 2 cm / HV22-EL	HV22
	HV22-ENT25	Sausage funnel 2.5 cm / HV22-EL	HV22
	HV22-G10	Disc 10 mm / HV22-EL	HV22
	HV22-G12	Disc 12 mm / HV22-EL	HV22
	HV22-G14	Disc diam. 14 mm / HV22-EL	HV22
	HV22-G16	Disc 16 mm / HV22-EL	HV22
HV22-G18	Disc diam. 18 mm / HV22-EL	HV22	
HV22-G20	Disc diam. 20 mm / HV22-EL	HV22	
HV22-G3	Disc 3 mm / HV22-EL	HV22	
HV22-G4.5	Disc 4.5 mm / HV22-EL	HV22	
HV22-G6	Disc 6 mm / HV22-EL	HV22	

Category	Ref.	Designation		
	HV22-G8	Disc 8 mm / HV22-EL	HV22	
	HV22-GX10	Disc in stainless steel 10 mm for electric meat mincer / HV22-XEL	HV22-XEL	
	HV22-GX12	Stainless steel disc 12 mm for electric meat mincer / HV22-XEL	HV22-XEL	
	HV22-GX14	Disc in stainless steel 14 mm dor electric meat mincer / HV22-XEL	HV22-XEL	
	HV22-GX16	Stainless steel disc 16 mm for eletric meat mincer / HV22-XEL	HV22-XEL	
	HV22-GX18	Disc in stainless steel 18 mm dor electric meat mincer / HV22-XEL	HV22-XEL	
	HV22-GX20	Disc in stainless steel 20 mm dor electric meat mincer / HV22-XEL	HV22-XEL	
	HV22-GX4.5	Disc in stainless steel 4.5 mm dor electric meat mincer / HV22-XEL	HV22-XEL	
	HV22-GX6	Disc in stainless steel 6 mm dor electric meat mincer / HV22-XEL	HV22-XEL	
	HV22-GX8	Disc in stainless steel 8 mm dor electric meat mincer / HV22-XEL	HV22-XEL	
	HV22-HEL	Propeller / HV22-EL	HV22	
	HV22-INT	Switch on - off / HV22-EL	HV22-EL	
	HV22-PE	Cable gland / HV22-EL	HV5-EL	
	HV22-VIR	Ring nut / HV22-EL	HV22	
	HV22-VIS	Endless screw / HV22-EL	HV22	
	HV5-C	Blade / HV5-EL	HV5	
	HV5-CAP-HEL	Plastic hood (propeller side) / HV5-EL	HV5-EL	
	HV5-CORPS	Cast iron main / HV5-EL	HV5	
HV5 HV12 HV22 HV12-EL HV5-EL HV22-EL HV22-XEL	HV5-COUR	Plastic crown / HV5-EL	HV5	
	HV5-CR	Gear cover + oil seal / HV5-EL	HV5	
	HV5-CRJ	Gear bracket seal / HV5-EL	HV5	
	HV5CT3-ENG	Set of 2 gears / HV5-EL / CT3-EL	HV5 / CT3	
	HV5-ELM	Engine alone / for HV5-EL	HV5-EL	
	HV5-ENG-P	Small gear / HV5-EL	HV5	
	HV5-ENT15	Sausage funnel 1.5 cm / HV5-EL	HV5	
	HV5-ENT20	Sausage funnel 2 cm / HV5-EL	HV5	
	HV5-ENT25	Sausage funnel 2.5 cm / HV5-EL	HV5	
	HV5-G10	Disc 10 mm / HV5-EL	HV5	
	HV5-G4.5	Disc 5.5 mm / HV5-EL	HV5	
	HV5-G6	Disc 6 mm / HV5-EL	HV5	
	HV5-G8	Disc 8 mm / HV5-EL	HV5	
	HV5-HEL	Propeller / HV5-EL	HV5	
	HV5-INT	Switch on - off / HV5-EL	HV5	
	HV5-J	Reducer lid sealing gasket	HV5-EL	
	HV5-PIL	Pusher pestle / HV5-EL	HV5	
	HV5-PL	Dish / HV5-EL	R HV5	
	HV5-SOC	Base / HV5EL	HV5	
	HV5-VIR	Ring nut / HV5-EL	HV5	
	HV5-VIS	Endless screw + square screw / HV5-EL	HV5-EL	
		HVCT-HUILE	Engine oil bottle electric meat mincers and tomate sauce appliances	HV22
	N5600	N5600-A	Ring seal / N5600	N5600
		N5600-AC	Knife axis / N5600	N5600
		N5600-AX	Motor output axis / - N5600	N5600
N5600-B		Trefoil nut/ring / N5600	N5600	
N5600-CAD		Bottom frame / N5600 Piece #31	N5600	
N5600-CAP		Plastic housing alone / N5600	N5600	
N5600-E		Plastic push / N5600	N5600	
N5600-IC		Complete switch / N5600	N5600	
N5600-M		Motor for electric meat mincer / N5600 (# 202)	N5600	
N5600-P		Tray / N5600	N5600	
N5600-PI		Output gear / N5600 (piece #215)	N5600	
N5600-PM		Intermediate metal gear	N5600	
N5600-PP		Bottom plastic gear	N5600	
N5600-T		Chopper head (g-mark) / N5600	N5600	
N5600-V		Endless scew / n5600	N5600	
TINNED MANUAL MEAT MINCERS				
N4005C N4008C N4010C	N40504C	Disc Ø 4,5 mm for manual meat mincer #5 / N4005C	N4005C	
	N40506C	Disc Ø 6,5 mm for manual meat mincer #5 / N4005C	N4005C	
	N40508C	Disc Ø 8 mm for manual meat mincer #5 / N4005C	N4005C	
	N40804C	Disc Ø 4,5 mm for manual meat mincer #8 / N4008C	N4008C	
	N40806C	Disc Ø 6,5 mm for manual meat mincer #8 / N4008C	N4008C	
	N40808C	Disc Ø 8 mm for manual meat mincer #8 / N4008C	N4008C	
	N40812C	Disc Ø 12 mm for manual meat mincer #8/ N4008C	N4008C	

Category	Ref.	Designation		
N4005C N4008C N4010C	N40104C	Disc Ø 4,5 mm for manual meat mincer #10 / N4010C	N4010C	
	N40106C	Disc Ø 6,5 mm for manual meat mincer #10 / N4010C	N4010C	
	N40108C	Disc Ø 8 mm for manual meat mincer #10 / N4010C	N4010C	
	N40112C	Disc Ø 12 mm for manual meat mincer #10 / N4010C	N4010C	
	N40115C	Disc Ø 15 mm for manual meat mincer #10 / N4010C	N4010C	
	N4005C-B	Tightening screw for manual meat mincer #5 / N4005C	N4005C	
	N40051C	4 branches blade for manual meat mincer #5 / N4005C	N4005C	
	N4005C-BP	Worm screw plastic ring for meat mincer #5 / N4005C	N4005C	
	N4005C-M	Handle for manual meat mincer #5 / N4005C	N4005C	
	N4005C-VF	Handle fixing screw for manual meat mincer #5 / N4005C	N4005C	
	N4005C-V	Endless screw for manual meat mincer #5 / N4005C	N4005C	
	N4008C-B	Tightening screw for manual meat mincer #8 / N4008C	N4008C	
	N40081C	4 branches blade for manual meat mincer #8 / N4008C	N4008C	
	N4008C-BP	Worm screw plastic ring for meat mincer #8 / N4008C	N4008C	
	N4008C-M	Handle for manual meat mincer #8 / N4008C	N4008C	
	N4008C-VF	Handle fixing screw for manual meat mincer #8 / N4008C	N4008C	
	N4008C-V	Endless screw for manual meat mincer #8 / N4008C	N4008C	
	N4010C-B	Tightening screw for manual meat mincer #10 / N4010C	N4010C	
	N40101C	4 branches blade for manual meat mincer #10 / N4010C	N4010C	
	N4010C-BP	Worm screw plastic ring for meat mincer #10 / N4010C	N4010C	
	N4010C-M	Handle for manual meat mincer #10 / N4010C	N4010C	
	N4010C-VF	handle fixing screw for manual meat mincer #10 - N4010C	N4010C	
	N4010C-V	Endless screw for manual meat mincer #10 / N4010C	N4010C	
	N4005C-S	Sausage funnel Ø13, 17 & 19 mm / N4005C	N4005C	
	N4008C-S	Sausage funnel Ø13, 17 & 19 mm / N4008C	N4008C	
	N4010C-S	Sausage funnel Ø13, 17 & 19 mm / N4010C	N4010C	
	N4022C N4032C	N40204C	Disc Ø 4,5 mm for manual meat mincer #22 / N4022C	N4022C
		N40206C	Disc Ø 6,5 mm for manual meat mincer #22 / N4022C	N4022C
		N40208C	Disc Ø 8 mm for manual meat mincer #22 / N4022C	N4022C
		N40212C	Disc Ø 12 mm for manual meat mincer #22 / N4022C	N4022C
		N40215C	Disc Ø 15 mm for manual meat mincer #22 / N4022C	N4022C
		N40221C	Blade for manual meat mincer #22 / N4022C	N4022C
		N4022C-B	Tightening screw for manual meat mincer #22 / N4022C	N4022C
N4022C-BP		Worm screw plastic ring for meat mincer #22 / N4022C	N4022C	
N4022C-M		Handle for manual meat mincer #22 / N4022C	N4022C	
N4022C-S		Sausage funnel- set of 3 (Ø13, 17 & 19 mm) / N4022C	N4022C	
N4022C-V		Endless screw for manual meat mincer #22 / N4022C	N4022C	
N4022C-VF		Handle fixing screw for manual meat mincer #22 / N4022C	N4022C	
N40304C		Disc Ø 4,5 mm for manual meat mincer #32 / N4032C	N4032C	
N40306C		Disc Ø 6,5 mm for manual meat mincer #32 / N4032C	N4032C	
N40308C		Disc Ø 8 mm for manual meat mincer #32 / N4032C	N4032C	
N40312C		Disc Ø 12 mm for manual meat mincer #32 / N4032C	N4032C	
N40315C		DISC Ø 15 mm for manuel meat mincer #32 / N4032C	N4032C	
N40321C		Blade for manual meat mincer #32 / N4032C	N4032C	
N4032C-B		Tightening screw for manual meat mincer #32 / N4032C	N4032C	
N4032C-BP		Worm screw plastic ring for meat mincer #32 / N4032C	N4032C	
N4032C-M		Handle for manual meat mincer #32 / N4032C	N4032C	
N4032C-S	Sausage funnel - set of 3 (Ø13, 17 & 19 mm) / N4032C	N4032C		
N4032C-V	Endless screw for manual meat mincer #32 / N4032C	N4032C		
N4032C-VF	Handle fixing screw for manual meat mincer #32 / N4032C	N4032C		
ST/ST MANUAL MEAT MINCERS				
N4008CX N4010CX	N40081CX	St/st blade for manual st/st meat mincer #8 / N4008CX	N4008CX	
	N4008CX-B	Tightening screw for manual st/st meat mincer #8 / N4008CX	N4008CX	
	N4008CX-M	Handle for manual st/st meat mincer #8 / N4008CX	N4008CX	
	N40101CX	St/st blade for manual st/st meat mincer #10 / N4010CX	N4010CX	
	N40104CX	Disc Ø 4,5 mm for manual st/st meat mincer #10 / N4010CX	N4010CX	
	N40106CX	Disc Ø 6,5 mm for manual st/st meat mincer #10 / N4010CX	N4010CX	
	N40108CX	Disc Ø 8 mm for manual st/st meat mincer #10 / N4010CX	N4010CX	
	N4010CX-B	Tightening screw for manual st/st meat mincer #10 - N4010CX	N4010CX	
	N4010CX-M	Handle for manual st/st meat mincer #10 / N4010CX	N4010CX	
	N40112CX	Disc Ø 12 mm for manual st/st meat mincer #10 / N4010CX	N4010CX	
	N40115CX	Disc Ø 15 mm for manual st/st meat mincer #10 / N4010CX	N4010CX	
	N40804CX	Disc Ø 4,5 mm for manual st/st meat mincer #8 / N4008CX	N4008CX	

Category	Ref.	Designation		
N4008CX N4010CX	N40806CX	Disc Ø 6,5 mm for manual st/st meat mincer #8 / N4008CX	N4008CX	
	N40808CX	Disc Ø 8 mm for manual st/st meat mincer #8 / N4008CX	N4008CX	
	N40812CX	Disc Ø 12 mm for manual st/st meat mincer #8 / N4008CX	N4008CX	
	N4008CX-V	Endless screw for manual st/st meat mincer #8 / N4008CX	N4008CX	
	N4010CX-V	Endless screw for manual st/st meat mincer #10 / N4010CX	N4010CX	
VACUUM SEALING MACHINE (SE)				
	NV400-8	Foam seal / NV400	NV400	
	NV400-C	Pcb card / NV400	NV400	
CHÂTEAU CUTTER				
MLT	GX017-4	St/st short feet - set of 4	MLT.	
	GX016-12	Suction + suction ring - set of 12	MLT.	
	MLT01.	St/st blade	MLT.	
	MLT02-3	Set of 6 blade screws	MLT.	
	MLT03	Blade supports right & left	MLT.	
	MLT04-2	Set of 2 blade adjust screw + ring	MLT.	
	O2873-5	Courbhane ring + metal ring - set of 5	MLT.	
	MLT05	Spike	MLT.	
	MLT06	Blade stop/adjust	MLT.	
	MLT07	Knurled knob / rotation	MLT.	
	MLT37585-7	Rolling bearing - set of 7	MLT.	
	MLT37530	Rotative lever for blade - set of 2	MLT.	
PASTA MACHINE (SE)				
N8001 N8001C N8004 N8005 N7994	N8001-ACC	Spaghetti & tagliatelle accessory / N8001 / N7994	N8001 / N7994	
	N8001C-ACC	Spaghetti & tagliatelle accessory / N8001C	N8001C	
	N8001-V	Clamp fixation - pasta machine / N8001	N8001	
	N8004T	Plastic hopper / N8004	N8004	
	N8005P	Gear / N8005	N8005	
N7900	N7900-M	Handle / N7900	N7900	
	N7900-P	Set of 4 feet / N7900	N7900	
	N7900-SJ	Clamp fixation / N7900	N7900	
MANDOLINE				
10000 15000 25000	10201	Universal safety guard - plastic - black color	15000 / 25000	
	15210	Waffle blade + support	15000	
	10216	Blade + knurled fixation nut	15000 / 10000	
	10202	Unit blade cutting 2 mm	15000 / 10000 / 25000	
	10210	Unit blade cutting 10 mm	15000 / 10000 / 25000	
	10201-3	Unit blade cutting 1 mm	15000 / 10000 / 25000	
	15020-N	Reversible stand / black	15000	
	10211	Box of 4 units blade cutting 2 - 4 - 7 & 10 mm	15000 / 10000 / 25000	
	10213	Box of 3 units blade cutting 1 - 2 & 4 mm	15000 / 10000 / 25000	
	10204	Unit blade cutting 4 mm	15000 / 10000 / 25000	
	10207	Unit blade cutting 7 mm	15000 / 10000 / 25000	
	10201-LV	Universal safety guard - plastic - red color	10000	
	15020-LV	Reversible stand / red	10000	
	10207	Unit blade cutting 7 mm	15000 / 10000 / 25000	
	190CL-20	Non skid pad / stop - set of 20	25000	
	181CL-5	Table edge support - set of 5	25000	
	30300	St/st protective carriage - plastic handle	25000	
	30400	St/st protective carriage - wood handle	25000	
	10215	Waffle cutter	25000	
	166CL	Foldable stand (without table edge support)	25000	
	20638B 20644B 20660B 20638CHB 20644CHB 20660 CHB 20638CHBB 20644CHBB 20660CHBB	190CL-20	Non skid pad / stop - set of 20	20638B-44B-60B-38CHB-44CHB-60CHB-38CHBB-44CHBB-60CHBB-21038 / 21044 / 21060
		176CL	Straight central blade	20638B-44B-60B-38CHB-44CHB-60CHB-38CHBB-44CHBB-60CHBB-21038 / 21044 / 21060
		30300	St/st protective carriage - plastic handle	20638B-44B-60B-38CHB-44CHB-60CHB-38CHBB-44CHBB-60CHBB-21038 / 21044 / 21060
	30400	St/st protective carriage - wood handle	20638B-44B-60B-38CHB-44CHB-60CHB-38CHBB-44CHBB-60CHBB-21038 / 21044 / 21060	
21038 21044 21060	10201	Universal safety guard - plastic - black color	20638B-44B-60B-38CHB-44CHB-60CHB-38CHBB-44CHBB-60CHBB-21038 / 21044 / 21060	
	19638	Cutter 38 blades (3 & 10 mm) - without handle	20638B-44B-60B-38CHB-44CHB-60CHB-38CHBB-44CHBB-60CHBB-21038 / 21044 / 21060	

Category	Ref.	Designation	
20638B 20644B 20660B 20638CHB 20644CHB 20660 CHB 20638CHBB 20644CHBB 20660CHBB 21038 21044 21060	10644	Cutter 44 blades (3 & 7 mm) - without handle	20638B-44B-60B-38CHB-44CHB-60CHB-38CHBB-44CHBB-60CHBB-21038 / 21044 / 21060
	11660	Cutter 60 blades (2 & 4,5 mm) - without handle	20638B-44B-60B-38CHB-44CHB-60CHB-38CHBB-44CHBB-60CHBB-21038 / 21044 / 21060
	183CL	Handle for cutter	20638B-44B-60B-38CHB-44CHB-60CHB-38CHBB-44CHBB-60CHBB-21038 / 21044 / 21060
	126CL	Fluted cutting plate	20638B-44B-60B-38CHB-44CHB-60CHB-38CHBB-44CHBB-60CHBB-21038 / 21044 / 21060
	181CL-5	Table edge support - set of 5	20638B-44B-60B-38CHB-44CHB-60CHB-38CHBB-44CHBB-60CHBB-21038 / 21044 / 21060
	146CL	Main plate	20638B-44B-60B-38CHB-44CHB-60CHB-38CHBB-44CHBB-60CHBB-21038 / 21044 / 21060
	166CL	Foldable stand (without table edge support)	20638B-44B-60B-38CHB-44CHB-60CHB-38CHBB-44CHBB-60CHBB-21038 / 21044 / 21060

STAINLESS STEEL TRUFFLES SLICER

1010CT	1070CT	St/st blade + key + screws	1010CT
	1042CT	Spare part set for thickness cutting adjustment	1010CT

JAPANESE MANDOLINE SLICER

120JB 95JB 8485JAPGN 64JB 8486JAPP 8490JAPP	120FL	Flat blade / 120JB / 95JB / 8484JAPJ	120JB / 95JB / 8485JAPGN
	120PO	Guard / 120JB / 8484JAPJ	120JB / 8485JAPGN
	64FL	Flat blade / 64JB	64JB
	64PO	Guard / 64JB / 8486JAPP	64JB / 8486JAPP
	8485BR	Metallic adjustment screw old model / 8485JAPG	8485JAPGN
	8485BS	Metal adjust. screw for cutting blade (triangle old mood) / 8485JAPG	8485JAPG
	8485FL	Flat blade / 8485JAPG	8485JAPGN / 95JB
	8485LA	Large cutting blade / 8485JAPG / 95JB	8485JAPGN / 95JB
	8485MO	Medium cutting blade / 8485JAPG / 95JB	8485JAPGN / 95JB
	8485PL	Half triangle plasticboard / 8485JAPG	8485JAPGN
	8485PO	Guard / 8485JAPG	8485JAPGN
	8485V	Flat blade metal screw / 8485JAPG / 8486JAPP	8485JAPGN
	8486BR*	Adjustment plastic screw, yellow, old model / 8486JAPP	8486JAPP
	8486BS*	Plastic tightening screw, yellow, old model / 8486JAPP	8486JAPP
	8486FI	Fine cutting blade / 8486JAPP / 8490 JAPP / 64JB	8486JAPP / 8490JAPP / 64JB
	8486FL	Flat blade / 8486JAPP	8486JAPP
	8486LA	Large cutting blade / 8486JAPP / 8490JAPP / 64JB	8486JAPP / 8490JAPP / 64JB
	8486MO	Medium cutting blade / 8486JAPP / 8490JAPP / 64JB	8486JAPP / 8490JAPP / 64JB
	8486PO	Guard / 8486JAPP	8486JAPP
	848BRN	Adjustment screw metallic, new model / 8485JAPG / 8486JAP	8485JAPGN / 8486JAPP
	848BSN	Metal adjust screw (new model) / 8486JAPP / 8490JAPP / 8485JAPG / 64JB / 95JB	8486JAPP/8490JAPP/8485JAPGN/64JB/95JB
	95PO	Guard / 95JB / 8485JAPG	8485JAPGN / 95JB

SOUP WARMER

N8060	N8060-06	Heating resistance	N8060
	N8060-08	Thermostat	N8060
	N8060-09	133°C fuse	N8060
	N8060-10	Aluminium tank	N8060
	N8060-13	Green indicator light	N8060
	N8060-14	Thermostat temperature regulator	N8060
	N8060-15	Switch button	N8060
	N8060-18	Stainless steel tank	N8060
	N8060-19	Stainless steel lid	N8060
	N8060-17	Collar top tank	N8060

FOOD MILLS

S3	S3002	Shaft, handle & crossbar for tinned mill S3	S3
	S3003-3	4 rubbers for S3 & X3-F - set of 3 (12 pcs)	S3
	S3004-2	Set of 2 handles + 2 rings + 5 clips handle / S3	S3
	S3015	Sieve 1,5 mm - tinned / S3	S3
	S3025	Sieve 2,5 mm - tinned / S3	S3
	S3040	Sieve 4 mm - tinned / S3	S3
	S3006-10	Clip handle/ S3 / X3-F - set of 10	S3
	S3001	Cone - tinned - / S3	S3

Category	Ref.	Designation		
X3-F	X3002	Shaft, handle & crossbar for st/st mill X3-F	X3-F	
	S3003-3	4 rubberS for S3 & X3-F - set of 3 (12 pieces)	X3-F	
	X3004-2	Set of 2 handles + 2 rings + 5 clips handle / X3-F	X3-F	
	X3015	St/st sieve 1,5 mm / X3-F	X3-F	
	X3025	St/st sieve 2,5 mm / X3-F	X3-F	
	X3040	St/st sieve 4 mm / X3-F	X3-F	
	S3006-10	Clip handle/ S3 & X3-F - set of 10	X3-F	
	X3001	Cone - st/st - / X3-F	X3-F	
M5	M5002	Shaft, handle & crossbar for tinned mill M5	M500 / M510 / M515 / M520 / M530 / M540	
	X5003-4	Holding spring - set of 4	M500 / M510 / M515 / M520 / M530 / M540	
	M5005-2	Set of 2 handles & 2 rings for tinned mill M5 + 5 clips handle	M500 / M510 / M515 / M520 / M530 / M540	
	M5010	Sieve Ø 1 mm - tinned - / M5	M500 / M510 / M515 / M520 / M530 / M540	
	M5015	Sieve Ø 1,5 mm - tinned - / M5	M500 / M510 / M515 / M520 / M530 / M540	
	M5020	Sieve Ø 2 mm - tinned - / M5	M500 / M510 / M515 / M520 / M530 / M540	
	M5030	Sieve Ø 3 mm - tinned - / M5	M500 / M510 / M515 / M520 / M530 / M540	
	M5040	Sieve Ø 4 mm - tinned - / M5	M500 / M510 / M515 / M520 / M530 / M540	
	M5006-10	Clip handle / M5 - set of 10	M500 / M510 / M515 / M520 / M530 / M540	
	M5001	Cone - tinned - / M5	M500 / M510 / M515 / M520 / M530 / M540	
	M5004	Ring support / M5	M500 / M510 / M515 / M520 / M530 / M540	
X5	X5002	Shaft, handle & crossbar for st/st mill X5	X500 / X510 / X515 / X520 / X530 / X540	
	X5003-4	Holding spring - set of 4	X500 / X510 / X515 / X520 / X530 / X540	
	X5005-2	Set of 2 handles for X5 & EX5 + 5 clips handle	X500 / X510 / X515 / X520 / X530 / X540	
	X5010	St/st sieve Ø 1 mm / X5	X500 / X510 / X515 / X520 / X530 / X540	
	X5015	St/st sieve Ø 1,5 mm / X5	X500 / X510 / X515 / X520 / X530 / X540	
	X5020	St/st sieve Ø 2 mm / X5	X500 / X510 / X515 / X520 / X530 / X540	
	X5030	St/st sieve Ø 3 mm / X5	X500 / X510 / X515 / X520 / X530 / X540	
	X5040	St/st sieve Ø 4 mm / X5	X500 / X510 / X515 / X520 / X530 / X540	
	M5006-10	Clip handle / X5 - set of 10	X500 / X510 / X515 / X520 / X530 / X540	
	X5001	Cone - st/st - / X5	X500 / X510 / X515 / X520 / X530 / X540	
P10	P10001	Cone - tinned - / P10	P1000 / P1010 / P1015 / P1020 / P1030 / P1040	
	P10002	Shaft / P10	P1000 / P1010 / P1015 / P1020 / P1030 / P1040	
	P10003-5	Central spiral spring -set of 5	P1000 / P1010 / P1015 / P1020 / P1030 / P1040	
	X5003-4	Holding spring - set of 4	P1000 / P1010 / P1015 / P1020 / P1030 / P1040	
	P10004	Anti splash housing	P1000 / P1010 / P1015 / P1020 / P1030 / P1040	
	P10005	Cross bar / P10	P1000 / P1010 / P1015 / P1020 / P1030 / P1040	
	P10006	Crank + handle + ring + clip handle / P10	P1000 / P1010 / P1015 / P1020 / P1030 / P1040	
	ONS01	Set of 2 handles + 2 rings + 5 clips handle / P10	P1000 / P1010 / P1015 / P1020 / P1030 / P1040	
	P10007	Tripod	P1000 / P1010 / P1015 / P1020 / P1030 / P1040	
	P10010	Sieve Ø 1 mm - tinned - / P10	P1000 / P1010 / P1015 / P1020 / P1030 / P1040	
	P10015	Sieve Ø 1,5 mm - tinned - / P10	P1000 / P1010 / P1015 / P1020 / P1030 / P1040	
	P10020	Sieve Ø 2 mm - tinned - / P10	P1000 / P1010 / P1015 / P1020 / P1030 / P1040	
	P10030	Sieve Ø 3 mm - tinned - / P10	P1000 / P1010 / P1015 / P1020 / P1030 / P1040	
	P10040	Sieve Ø 4 mm - tinned - / P10	P1000 / P1010 / P1015 / P1020 / P1030 / P1040	
	M5006-10	Clip handle / P10 - set of 10	P1000 / P1010 / P1015 / P1020 / P1030 / P1040	
	EX5	EX5010	St/st sieve Ø 1 mm / EX5	EX5M100 / EX5M130 / EX5T100 / EX5T130
		EX5015	St/st sieve Ø 1,5 mm / EX5	EX5M100 / EX5M130 / EX5T100 / EX5T130
EX5020		St/st sieve Ø 2 mm / EX5	EX5M100 / EX5M130 / EX5T100 / EX5T130	
EX5030		St/st sieve Ø 3 mm / EX5	EX5M100 / EX5M130 / EX5T100 / EX5T130	
EX5040		St/st sieve Ø 4 mm / EX5	EX5M100 / EX5M130 / EX5T100 / EX5T130	
E5055		Single phase motor 220 v	EX5M100 / EX5M130	
E5074		Single phase motor 110 v	EX5M100 / EX5M130	
E5059		3 phases motor 380 v	EX5T100 / EX5T130	
E5073		single phase interruptor - with reverse	EX5M100 / EX5M130	
E5072		3 phase interruptor - with reverse	EX5T100 / EX5T130	
E5068		On - off mono button / EX5	EX5M100 / EX5M130 / EX5T100 / EX5T130	
E5063		Reducing gear	EX5M100 / EX5M130 / EX5T100 / EX5T130	
E5064		Bronze wheel	EX5M100 / EX5M130 / EX5T100 / EX5T130	
E5065		Endless screw	EX5M100 / EX5M130 / EX5T100 / EX5T130	
E5071		Axis - hexagon socket	EX5M100 / EX5M130 / EX5T100 / EX5T130	
EX5053		Aluminium bushing	EX5M100 / EX5M130 / EX5T100 / EX5T130	
EX5051		Shaft / EX5	EX5M100 / EX5M130 / EX5T100 / EX5T130	
X5003-4		Holding spring - set of 4	EX5M100 / EX5M130 / EX5T100 / EX5T130	
EX5052		Crossbar - bushing - protection	EX5M100 / EX5M130 / EX5T100 / EX5T130	
EX5070		St/st stand + motor support	EX5M100 / EX5M130 / EX5T100 / EX5T130	

Category	Ref.	Designation	
EX5	P10003-5	Central spiral spring -set of 5	EX5M100 / EX5M130 / EX5T100 / EX5T130
	EX5050	Anti splash cylinder	EX5M100 / EX5M130 / EX5T100 / EX5T130
	EX5069	Ring support	EX5M100 / EX5M130 / EX5T100 / EX5T130
	E5053	Capacitor / EX5	EX5M100 / EX5M130 / EX5T100 / EX5T130
	E5054	Klixon / EX5	EX5M100 / EX5M130 / EX5T100 / EX5T130
	E5066	Alu tip / EX5 old model	EX5M100 / EX5M130 / EX5T100 / EX5T130
	EX5001	Cone for electric st/st mill / MILL EX5	EX5M100 / EX5M130 / EX5T100 / EX5T130
	E5056	Mono switch with inverter / model before 2009/ electric mill / EX5	EX5M100 / EX5M130
	E5057	Single phase on - off switch (without inverter) / electric mill / EX5	EX5M100 / EX5M130
	E5061	Three phase on - off switch (without inverter) / EX5T	EX5T100 / EX5T130

ELECTRIC CAN OPENERS

OEXTC	GX017-4	St/st short feet - set of 4	OEXTC	
	GX016-12	Suction + suction ring - set of 12	OEXTC	
	OE7417	Sliding plastic guide	OEXTC	
	OE7489-2	Adjusting height handle - set of 2	OEXTC	
	OE7492	Air spring	OEXTC	
	OE7518	Height screw stop / clamping screw	OEXTC	
	OE7554-2	Cog-wheel Ø 36 mm - set of 2	OEXTC	
	O2830-5	St/st blade - set of 5	OEXTC	
	OE896	Kit : cog-wheel, st/st blade, metallic brush, courbhane ring, metal ring + remove cog-wheel tool	OEXTC	
	OE7432	Articulation U + axle	OEXTC	
	OE50021	Opening head - with rings	OEXTC	
	OE7441	Lever + handle	OEXTC	
	OE7520	Captive head fixation screw with ring	OEXTC	
	OE50012	Inferior flange	OEXTC	
	OE7426	Upper flange	OEXTC	
	OE7435	Interruptor (without protection cap)	OEXTC	
	OE7434-5	Protection switch on-off - set of 5	OEXTC	
	OE7445	Magnet for lid	OEXTC	
	OE7551	Head plastic ring x2	OEXTC	
	OE7589	Remove cog-wheel tool	OEXTC	
	OE57257	Power cable	OEXTC	
	OE50011	Axle / cog-wheel rotation	OEXTC	
	OE7459-3	Screw blade - set of 3	OEXTC	
	OE50020	Motor unit without housing	OEXTC	
	OE50014	Motor housing alone	OEXTC	
	OE7491	St/st column	OEXTC	
	OE7405	St/st table stand	OEXTC	
	OEX821	Metalic brush	OEXTC	
	OE50030	Electronic card + filter	OEXTC	
	O2873-5	Courbhane ring + metal ring - set of 5	OEXTC	
	OE7559-3	Screw lever - set of 3	OEXTC	
	OE50065	Large gear	OEXTC	
	OE50075	Small gear	OEXTC	
	OE50070	Mid gear	OEXTC	
	OE50018	Adjusting can height	OEXTC	
	OE7231	Blade pin	OEXTC	
	OE7404	Axis / head articulation	OEXTC	
	OE50080	Set of carbon brushes	OEXTC	
	OE29046	Handle / lever	OEXTC	
	OE7237	Adjusting screw for U blade / wheel	OEXTC	
	OE50029	Head bearing plate	OEXTC	
	OE750	OE7518	Height screw stop / clamping screw	OE750M / OE750T / OE750M-110
		OE7543	Air spring	OE750M / OE750T / OE750M-110
		OE7502	Spare parts kit : cog-wheels Ø 36mm & Ø 70mm + st/st blade + brush + remove cog wheel tool	OE750M / OE750T / OE750M-110
		OE7575	Articulation U + axle	OE750M / OE750T / OE750M-110
OE7576		Lever with handle	OE750M / OE750T / OE750M-110	
OE7565		Complete pusher / lever	OE750M / OE750T / OE750M-110	
OE7551		Head plastic ring x2	OE750M / OE750T / OE750M-110	
OE7552		Axle / cog-wheel rotation	OE750M / OE750T / OE750M-110	

Category	Ref.	Designation	
OE750	OE7516	Motor unit - single phase 220v - without housing	OE750M
	OE7516T	Motor unit - 3 phases - 380v - without housing	OE750T
	OE7534-2	Guiding ring / column - set of 2	OE750M / OE750T / OE750M-110
	OE7553	Cog-wheel Ø 70 mm	OE750M / OE750T / OE750M-110
	O2830-5	St/st blade - set of 5	OE750M / OE750T / OE750M-110
	OE7559-3	Screw lever - set of 3	OE750M / OE750T / OE750M-110
	OE7520	Captive head fixation screw with ring	OE750M / OE750T / OE750M-110
	OE7524	Single phase interruptor (air pressure)	OE750M / OE750M-110
	OE7610	3 phases interruptor (connecting box)	OE750T
	OE7554-2	Cog-wheel Ø 36 mm - set of 2	OE750M / OE750T / OE750M-110
	OE7589	Remove cog-wheel tool	OE750M / OE750T / OE750M-110
	OE7503	Air pressure command - for single phase item	OE750M / OE750M-110
	OE7506-3	Connection piece - set of 3 -for single phase item	OE750M / OE750M-110
	OE7507	Motor output tube / air pressure command - for single phase item	OE750M / OE750M-110
	OE7521	Magnet for lid + magnet support	OE750M / OE750T / OE750M-110
	OE7556	Screw blade	OE750M / OE750T / OE750M-110
	OE7555	Blade shim	OE750M / OE750T / OE750M-110
	OE7548	Opening head - with rings	OE750M / OE750T / OE750M-110
	OE7598	Adjusting can height	OE750M / OE750T / OE750M-110
	OE7529	Inferior flange	OE750M / OE750T / OE750M-110
	OE7525	Upper flange	OE750M / OE750T / OE750M-110
	OE7231	Blade pin	OE750M / OE750T / OE750M-110
	OE7571	St/st colum x2	OE750M / OE750T / OE750M-110
	OE7504	St/st tube hiding air spring	OE750M / OE750T / OE750M-110
	OE7535	Stop ring motor unit height	OE750M / OE750T / OE750M-110
	OE7562	St/st table stand	OE750M / OE750T / OE750M-110
	OEX821	Metalic brush	OE750M / OE750T / OE750M-110
	OE7528	Motor housing	OE750M / OE750T / OE750M-110
	OE7557	Head bearing plate	OE750M / OE750T / OE750M-110
	OE7578	Axis / head articulation	OE750M / OE750T / OE750M-110
	OE7537	Capacitor	OE750M / OE750T / OE750M-110
	OE29046	Handle / lever	OE750M / OE750T / OE750M-110
	OE7567	Lifting bar / lever	OE750M / OE750T / OE750M-110
OE7570	Power cable - for single phase item	OE750M / OE750T / OE750M-110	

MANUAL CAN OPENERS

O2P55 O2V55	O2895	Kit including : blade, cog-wheel, rilsan lever, metal ring, courbhane ring, disassembly tool	O2V55 / O2P55
	O2830-5	St/st blade - set of 5	O2V55 / O2P55
	O2870-5	Rilsan lever for manual can opener / O2 / OX / OBSX - set of 5	O2V55 / O2P55
	O2877-5	Blade screw / O2 / O3 - set of 5	O2V55 / O2P55
	O2872-5	Nickeled steel plate / O2 / O3 - set of 5	O2V55 / O2P55
	ONS01	Set of 2 handles & 2 rings + 5 clips handle	O2V55 / O2P55
	O2880	Epoxy plate - to be bolted	O2P55
	O2890	Epoxy plate - clamp fixation	O2V55
	O2898	St/st table stand clamping screw + white cup	O2V55
	O2879-10	White cup / clamping screw - set of 10	O2V55
	O2873-5	Courbhane ring + metal ring - set of 5	O2V55 / O2P55
	O2820-2	Cog-wheel Ø 36 mm - set of 2	O2V55 / O2P55
	M5006-10	Clip handle - set of 10	O2V55 / O2P55
	O2840	Crank + handle + ring + clip handle	O2V55 / O2P55
	O2805	Opening head + 2 fixation screw (without blade / without cog-wheel)	O2V55 / O2P55
	OXP55 OXV55	O2895	Kit including : blade, cog-wheel, rilsan lever, metal ring, courbhane ring, disassembly tool
O2870-5		Rilsan lever for manual can opener / O2 / OX / OBSX - set of 5	OXV55 / OXP55
O2830-5		St/st blade - set of 5	OXV55 / OXP55
O2820-2		Cog-wheel Ø 36 mm - set of 2	OXV55 / OXP55
OXS02		Set of 2 handles + 3 screws	OXV55 / OXP55
OXS01		Set of 2 handles + 5 clips handle (before 2019)	OXV55 / OXP55
OX875-5		Blade screw for OX - set of 5	OXV55 / OXP55
OX880		St/st plate - to be bolted - with plastic insert	OXV55
OX890		St/st plate - clamp fixation - with plastic insert	OXV55
O2898		St/st table stand clamping screw + white cup	OXV55
O2879-10		White cup / clamping screw - set of 10	OXV55

Category	Ref.	Designation		
OXP55 OXV55	O2873-5	Courbhane ring + metal ring - set of 5	OXP55 / OXV55	
	O2891-5	Plastic insert for OX / OBSX - set of 5	OXP55 / OXV55	
	M5006-10	Clip handle - set of 10	OXP55 / OXV55	
	O2871-4	St/st can abutment - set of 4	OXP55 / OXV55	
	OX840	Crank + handle + screw	OXP55 / OXV55 / OBSXP55 / OBSXV55	
O3P40 O3V40	O3895	Kit including : blade, cog-wheel, rilsan lever, metal ring, courbhane ring, disassembly tool	O3P40 / O3V40	
	O3870-5	Rilsan lever for manual can opener / O3 / O5 / OX5 - set of 5	O3P40 / O3V40	
	O2877-5	Blade screw / O2 / O3 - set of 5	O3P40 / O3V40	
	O2872-5	Nickeled steel plate / O2 / O3 - set of 5	O3P40 / O3V40	
	ONS01	Set of 2 handles & 2 rings + 5 clips handle	O3P40 / O3V40	
	O2880	Epoxy plate - to be bolted	O3P40	
	O2890	Epoxy plate - clamp fixation	O3V40	
	O2898	St/st table stand clamping screw + white cup	O3V40	
	O2879-10	White cup / clamping screw - set of 10	O3V40	
	O2873-5	Courbhane ring + metal ring - set of 5	O3P40 / O3V40	
	O2820-2	Cog-wheel Ø 36 mm - set of 2	O3P40 / O3V40	
	O2830-5	St/st blade - set of 5	O3P40 / O3V40	
	M5006-10	Clip handle - set of 10	O3P40 / O3V40	
	O3840	Crank + handle + ring + clip handle	O3P40 / O3V40	
	OX5P55 OX5V55	O3895	Kit including : blade, cog-wheel, rilsan lever, metal ring, courbhane ring, disassembly tool	OX5P55 / OX5V55
O3870-5		Rilsan lever for manual can opener / O3 / O5 / OX5 - set of 5	OX5P55 / OX5V55	
OX501		Set of 2 handles + 5 clips handle	OX5P55 / OX5V55	
OX5880		St/st plate - to be bolted	OX5P55	
OX5890		St/st plate - clamp fixation	OX5V55	
O2820-2		Cog-wheel Ø 36 mm - set of 2	OX5P55 / OX5V55	
O2830-5		St/st blade - set of 5	OX5P55 / OX5V55	
O2898		St/st table stand clamping screw + white cup	OX5V55	
O2879-10		White cup / clamping screw - set of 10	OX5V55	
O2873-5		Courbhane ring + metal ring - set of 5	OX5P55 / OX5V55	
M5006-10		Clip handle - set of 10	OX5P55	
O2871-4		St/st can abutment - set of 4	OX5P55 / OX5V55	
OX5840		Crank + handle + clip handle	OX5P55 / OX5V55	
O5P55 O5V55		O3895	Kit including : blade, cog-wheel, rilsan lever, metal ring, courbhane ring, disassembly tool	O5P55 / O5V55
		O3870-5	Rilsan lever for manual can opener / O3 / O5 / OX5 - set of 5	O5V55 / O5P55
	ONS01	Set of 2 handles & 2 rings + 5 clips handle	O5P55 / O5V55	
	O2880	Epoxy plate - to be bolted	O5P55	
	O2890	Epoxy plate - clamp fixation	O5V55	
	O2820-2	Cog-wheel Ø 36 mm - set of 2	O5P55 / O5V55	
	O2830-5	St/st blade - set of 5	O5P55 / O5V55	
	O2898	St/st table stand clamping screw + white cup	O5V55	
	O2879-10	White cup / clamping screw - set of 10	O5V55	
	O2873-5	Courbhane ring + metal ring - set of 5	O5P55 / O5V55	
	M5006-10	Clip handle - set of 10	O5P55 / O5V55	
	O2871-4	St/st can abutment - set of 4	O5P55 / O5V55	
	O3840	Crank + handle + ring + clip handle	O5V55 / O5P55	
	OBSX	O2870-5	Rilsan lever for manual can opener / O2 / OX / OBSX - set of 5	OBSXV55 / OBSXP55
		OBSXS01	Set of 2 cog-wheels + 1 disassembly tool	OBSXP55 / OBSXV55
OBSX-28066		St/st plate - clamp fixation	OBSXV55	
OBSX-28061		St/st plate - to be bolted	OBSXP55	
OXS02		Set of 2 handles + 3 screws	OXP55 / OXV55 / OX5P55 / OX5V55	
O2898		St/st table stand clamping screw + white cup	OBSXV55	
O2879-10		White cup / clamping screw - set of 10	OBSXV55	
O2891-5		Plastic insert / OX / OBSX - set of 5	OBSXP55 / OBSXV55	
OBSXS04		Rolling bearings - set of 2	OBSXP55 / OBSXV55	
OBSXS02		Kit : blade + blade support + blade screw	OBSXP55 / OBSXV55	
OBSXS03		Kit blade mechanism : top locking, connector, rolling bearings	OBSXP55 / OBSXV55	
OX840		Crank + handle + screw	OBSXP55 / OBSXV55	

Category	Ref.	Designation	
APPLE PEELER KALI			
N4230	N6107	Endless screw - without spindle & handle	N4230
	N6113	Screw 6x10 / flat spring	N4230
	N6111	Adjustment screw	N4230
	N6104	Bow	N4230
	N6105	Bow spring	N4230
	N6114	Cam	N4230
	N6118-V	Endless screw thin slices - without spindle & handle	N4230
	N6106	Handle	N4230
	N6115	Flat spring	N4230
	N6108	Clamp	N4230
	N6117	Pad - set of 2	N4230
	N6116	Plastic insert	N4230
	N6110	Slicing & coring blade screw	N4230
	N6101	Slicing & coring blade	N4230
	N6102	Complete peeler	N4230
	N6103	Spindle	N4230
STAINLESS STEEL COFFEMAKERS			
N5308 N5312 N5316	N5308-23	Filter basket / N5308	N5308
	N5312-23	Filter basket / N5312 / N5316	N5312/N5316
	N5308-22	Percolator pipe / N5308	N5308
	N5312-22	Percolator pipe / N5312	N5312
	N5316-22	Percolator pipe / N5316	N5316
	N5308-14	Heating thermostat - 88°C / N5308 / N5312 / N5316	N5308/N5312/N5316
	N5308-12	Fuse + internal wire / N5308 / N5312 / N5316	N5308/N5312/N5316
	N5308-5	Tank handle x2 / N5308 / N5312 / N5316	N5308/N5312/N5316
	N5308-13	Anti-boil dry thermostat - 160°C / N5308 / N5312 / N5316	N5308/N5312/N5316
	N5308-19	Tap - whole set / N5308 / N5312 / N5316	N5308/N5312/N5316
	N5308-28	On - off switch / N5308 / N5312 / N5316	N5308/N5312/N5316
	N5308-32	Pilot light red & orange + internal wire / N5308	N5308
	N5316-32	Pilot light red & orange + internal wire / N5312 - N5316	N5312/N5316
	N5316-30	Keep warm resistance + support / N5308 / N5312 / N5316	N5308/N5312/N5316
	N5308-33	Heating resistance + silicon ring / N5308	N5308
	N5316-31	Heating resistance + silicon ring / N5312 / N5316	N5312/N5316
	N5312-COUV	Complete lid set / N5312 / N5316	N5312/N5316
	N5308-COUV	Complete lid set / N5308	N5308
	N5308-31	Complete base set / N5308	N5308
	N5316-33	Complete base set / N5312 / N5316	N5312/N5316
	N5308-30	Complete water gauge / N5308	N5308
	N5312-30	Complete water gauge / N5312	N5312
	N5316-34	Complete water gauge / N5316	N5316
	INSULATED JUGS (SE)		
N5076 N5077 N5078	N5076-B	Lid / N5076	N5076
	N5076-J	Gasket lid / N5076	N5076
	N5077-B	Lid / N5077	N5077
	N5077-J	Gasket lid / N5077	N5077
	N5078-B	Lid / N5078	N5078
N5084 N5085 N5089 N5088	N5084-B	Spare lid / N5084 / N5085 / N5087	N5084 / N5085
	N5084-T	Water lift rod / N5084 / old model	N5084
	N5085-T	Water lift rod / N5085	N5085
	N5088-B	Lid / N5089 / N5088	N5088 / N5089
	N5088-BN	Lid / N5089 / N5088 / new model	N5088 / N5089
	N5088-T	Water lift rod / N5088 / old model	N5088
	N5088-TNM	Water lift rod / N5088	N5088
	N5089-TNM	Water lift rod / N5089	N5089
N5069 N5070 N5071 N5072	N5069-B	Lid for / N5069	N5069
N5072-B	Lid for / N5070 / N5071 / N5072	N5070 / N5071 / N5072	
N5072-BN	Lid for / N5070 / N5071 / N5072 / new model	N5070 / N5071 / N5072	

Category	Ref.	Designation	
PLANCHETTA			
PLAN	PLAN-DAR-2	St/st cup - set of 2	PLAN01 / PLAN02
	PLAN-PEP	Enameled plate with juiced hole - 20 x 30 cm	PLAN01 / PLAN02
	PLAN-P	St/st holder for enameled plate	PLAN05 / PLAN01 / PLAN02
	190CL-20	Non skid pad / stop - set of 20	PLAN02
	BRU01-2	Alcohol burner - set of 2	PLAN01 / PLAN05 / PLAN02
	PLAN05-PEP	Enameled plate - 15 x 30 cm	PLAN05
GRIP HOLDER			
N8030 N8031	N8032-10	Set of 10 springs + screws for N8030 & N8031	N8030 / N8031
CAMEMBERT SLICER			
PF	PF006	St/st blade 6 wedges	PF01 / PF06 / PF08
	PF008	St/st blade 8 wedges	PF01 / PF06 / PF08
	PF001	Reversible tray 6 / 8 wedges	PF01 / PF06 / PF08
	PF010	Reversible tray 6 / 8 wedges with 2 columns	PF01 / PF06 / PF08
FILLERS (SE)			
N5750	N5700-B	Trefoil nut / N5700 / N5750	N5700 / N5750
	N5700-C	Tank / N5700 / N5750	N5700 / N5750
	N5750-GA	Large axis for handle / N5750	N5750
	N5700-PM	Metallic plate - pusher / N5700 - N5750	N5750
	N5750-J	Pistol rubber ring / N5750 / N5700	N5750
	N5750-M	Crank / N5750	N5750
	N5750-PA	Small axis for handle / N5750	N5750
PSX	PSXPRO-05-CR	Rack / PSXPRO-05/PSX05	PSX05
	PSXPRO-05-CUVE	St/steel tube / PSXPRO-05 / PSX05	PSX05
	PSXPRO-08-CUVE	St/steel tube / PSXPRO-08 / PSX08	PSX08
	PSXPRO-ENT	Set of 4 plastic funnels / PSXPRO-05 / -08 / -12 / PSXPRO-VE08 / PSX05 / 08	PSX05/PSX08
POMEGRANATE & CITRUS JUICER (SE)			
N4098	N4098-B	Lever arm / N4098 (NR 11)	N4098
	N4098-C	Spare juice squeezer	N4098
	N4098-COL	Column / N4098	N4098
	N4098-CP	Cone / N4098 / - part 7	N4098
	N4098-CS	Cone superior / N4098 / - part 6	N4098
	N4098-GC	Juice collector guide - part 4	N4098
	N4098-L	Lever set (N°11+18+13)	N4098
	N4098-P	Board support / N4098 / part N°28	N4098
	N4098-S	Base / N4098 / - part 5	N4098
	N4098-SB	Arm support - part 3	N4098
	N4098-SV	Glass support - part 9	N4098
STAINLESS STEEL CAN PRESS			
N8019	N8019-B	Bronze bearing block - set of 2	N8019
	N8019-BL	Brass ring (x1)	N8019
	N8019-RC	Lever lock spring	N8019
VEGETABLE SLICER			
4100CLR	10202	Unit blade cutting 2 mm	4100CLR
	10210	Unit blade cutting 10 mm	4100CLR
	10211	Box of 4 units blade cutting 2 - 4 - 7 & 10 mm	4100CLR
	10201-3	Unit blade cutting 1 mm	4100CLR
	4051-1	Handle (round axle)	4100CLR
	4141	Nails wheel	4100CLR
	4148	Straight blade + screw + wrench	4100CLR
	4056-3	Circular coring blade - set of 3 + tool	4100CLR
	GX016-12	Suction + suction ring - set of 12	4100CLR
	10213	Box of 3 units blade cutting 1 - 2 & 4 mm	4100CLR

Category	Ref.	Designation	
4100CLR	10204	Unit blade cutting 4 mm	4100CLR
	10207	Unit blade cutting 7 mm	4100CLR
	4150	Complete carriage	4100CLR
4030CLR	4051-1	Handle (round axle)	4030CLR
	4141	Nails wheel	4030CLR
	4056-3	Circular coring blade - set of 3 + tool	4030CLR
	GX016-12	Suction + suction ring - set of 12	4030CLR
	4043	Blade cutting 2 mm	4030CLR
	4044	Blade cutting 3 mm	4030CLR
	4045	Blade cutting 6 mm	4030CLR
	4054	Complete carriage	4030CLR

CREAM WHIPPER & SODA SIPHON

N4083X N4084X N4086X N4087X N4075X	NK752	Kit : straight + tulip nozzle / adapter / brush	N4086X/N4087X
	NK738	Charger holder + dust cap	N4086X/N4087X/N4075X
	NK5134	Valve	N4086X/N4087X
	NK750-3	Head gasket - set of 3	N4086X/N4087X/N4083X/N4084X
	NK755	Complete head	N4086X/N4087X
	NK652	Kit : straight + tulip nozzle / adapter / brush	N4086X/N4087X
	NK638	Charger holder + dust cap	N4086X/N4087X
	NK513A	Valve	N4086X/N4087X
	NK785	Complete head	N4086X/N4087X
	NK401	Kit : key + measuring tube + tube & gasket	N4075X
YC80105	NK774	Complete head	N4075X
	YC80105-21	Charger holder + dust cap	YC80105
	YC80105-22	Kit : 2 straight & 1 tulip decorating nozzles + 1 nozzle adaptor + 1 cleaning brush	YC80105
	YC80105-23	Head gasket - set of 3	YC80105
	YC80105-24	Valve	YC80105

SPIRAL FRIT'N CHIPS

CNX	GX017-4	St/st short feet - set of 4	CNX225
	GX016-12	Suction + suction ring - set of 12	CNX225
	4141	Nails wheel	CNX225 / CNX225-V
	N6116	Plastic insert	CNX225 / CNX225-V
	CNX225-L	Blade - thickness cutting 2,25 mm	CNX225 / CNX225-V
	CNX450-L	Blade - thickness cutting 4,5 mm	CNX225 / CNX225-V
	O2898	St/st table stand clamping screw + white cup	CNX225-V
	O2879-10	White cup / clamping screw - set of 10	CNX225-V

TWO WAYS EXPRESS SLICER

TAT	TAT01	St/st blade	TAT
	TAT02-5	Set of 10 screws	TAT
	190CL-20	Non skid pad / stop - set of 20	TAT
	TAT03	PEHD pusher	TAT
	CTXM07	Black handle + 2 screws	TAT

TURN'UP

TU	107TU	Circular blade protection cap	TU01
	108TU	Flat blade protection cap	TU01 / TU02
	102TU	St/st flat blade + screws	TU01
	101TU	Flat blade holder	TU01
	103TU	Ejector axis	TU01 / TU02
	104TU	Tube/circular blade holder (with pins)	TU01 / TU03
	105TU	St/st large circular blade	TU01
	205TU	St/st small circular blade / TU01 / large circular blade / TU02	TU01 / TU02
	207TU	Circular blade protection cap	TU02
	202TU	St/st flat blade + screws	TU02
	201TU	Flat blade holder	TU02
	204TU	Tube/circular blade holder (with pins)	TU02
	206TU	St/st small circular blade	TU02
	303TU	Ejector axis	TU03

Category	Ref.	Designation	
TU	305TU	St/st large circular blade	TU03
	308TU	St/st small circular blade	TU03
	306TU	Cut out bottom tool	TU03
	307TU	Circular blade protection cap	TU03
	5020-5	Black handle - set of 5	TU03

MISCELLANEOUS (SE)

OEXT2	R010	Little plastic gear	OEXT2
N4212	N4212-PV	Leg for coconuts cracker / N4212	N4212
N8090 N8091	N8091-C	Lid / N8091	N8091
	N8090-R	Heating element / N8091 / N8090	N8090 / N8091
	N8091-1	Top for water heater / N8091	N8091
N8110	N8110-C	Lid / N8110	N8110
CTE00	CTE01	5 blades for star cutter	CTE00

LOUIS TELLIER SAS

Registered Office : 116 Quai de Bezons – 95100 Argenteuil (France) – Tel : +33 134 113 838 – Fax : +33 134 111 850

Simplified Limited Company (SAS) with a share capital of €6 360 000

Trade and Company Register of Pontoise n° 49 259 93 86

Applicable as from 1st of January 2022

GENERAL TERMS AND CONDITIONS OF SALE

Placing an order implies unreserved acceptance by the purchaser of these sale terms & conditions and the reservation of ownership clause.

All trade negotiations are based exclusively on these sale terms & conditions.

1.OBJECT:

These sale Terms & Conditions apply to purchasers retailing and installing equipment for HORECA end-users (trade associated with human food, canteens, restaurants, hotels), and retailers selling directly to non-professional end-users for private use with regards to the sale of Tellier Gobel & Cie SAS collections incorporating LT Louis Tellier, Gobel, Broncoucke, Yoocook & La Bonne Graine.

2.ACCEPTANCE OF ORDERS:

All orders are registered without any undertaking as to delivery. Prices shall be notified in a document appended to the GTCS. In view of the fact that TG&C has a diversified distribution network, price reductions shall be stipulated by Tellier Gobel et Cie in category-specific terms and conditions of sale ("CTCS") which are established according to specific categories of Purchasers. Pursuant to Article L. 441-6 of the French Commercial Code (Code de commerce), Tellier Gobel et Cie shall send Purchasers, in the same category, its prices, completed by the GTCS and the CTCS. The prices, the GTCS and the CTCS together shall constitute the sole basis of the commercial negotiations and form an indivisible whole. Any order shall be governed by the GTCS/CTCS in force on the date on which the order is placed by the Purchaser. In regards of our diversity of network, every order will need to be accepted and notified by Tellier Gobel et Cie SAS. All cancellation (despite back orders) will have to be accepted and written by Tellier Gobel et Cie. Specific items and packaging cannot be cancelled if fabrics is started or sourcing is done.

3.WEIGHT & DIMENSIONS:

All weight and dimensions indicated in the catalogue are intended with a precision margin of +/- 5%. Any complaints relative to a lower deviation will not be accepted.

4.FREIGHT & SHORTAGE DELIVERIES:

Shipment to Metropolitan France will be carriage free for deliveries of a net value of at least €450 ex-VAT. Should any article including a new price, be unavailable, remains of orders of a net value of under €200 ex-VAT cannot be delivered carriage free.

For orders below €450 before tax, a carriage cost will be applied:

-€15 ex-VAT for orders below €150 ex-VAT

-€20 ex-VAT for orders below €300 ex-VAT

-€25 ex-VAT for orders below €450 ex-VAT

Shipment to foreign countries, DOM-TOM and Corsica starts from Joué-Les-Tours in EXW conditions. FCA French borders incoterm 2020 can be used as France delivery conditions as on above.

TG&C SAS is authorised to make complete or partial deliveries. All partial deliveries may be considered as separate contracts, and in consequence, the Purchaser may not rely upon the fact that it has waited for the remainder of its order as a reason to delay payment for the partial delivery that has been made.

5.SHIPMENT / INSPECTION ON DELIVERY:

The products and their packaging are always carried at the Purchaser's risk, even when sold with carriage paid. It is therefore incumbent upon the Purchaser, where appropriate, to protect its rights vis-à-vis carriers, in accordance with Articles L. 133-3 et seq. of the French Commercial Code, which indicates as follows:

"The receipt of the transported items shall extinguish any claim against the carrier for damage or partial loss if, within three days of this receipt, not including public holidays, the recipient has not notified the carrier, by extrajudicial means or registered letter, of its reasoned protest."

The Purchaser must record any reservations, which must be precise, reasoned and in writing, on the carrier's receipt and must inform TG&C without any delay. Without prejudice to the actions to be taken vis-à-vis the carrier, claims regarding apparent defects, missing products or the non-conformity of the products delivered in comparison with the products ordered or the dispatch note, must be made in writing within 15 calendar days¹ following the arrival of the said products. Claims made after this time limit will not be acted upon by TG&C.

It is the responsibility of the Purchaser to provide evidence of the defects or anomalies it has discovered. It must allow TG&C or its representative all opportunities to observe the said defects and to remedy them. The Purchaser shall refrain from acting itself or from causing a third party to act to this end. In the event of apparent defects, missing products, or damage, evidenced

in this way, TG&C's liability is strictly limited to an obligation to replace the said products to the exclusion of all damages. Delivery times are given for information purposes only and cannot be guaranteed in any way. The Purchaser may not rely upon a delayed delivery as a reason to cancel the order, in any event, or to refuse products in the event of a partial delivery, or as a reason to claim damages. Deliveries shall be made in accordance with availability and in the order in which the orders were received.

6.PRICES:

The prices of goods sold are those in force on the agreed date of delivery. They are expressed in Euros (€) ex-VAT for packaged products. They will therefore be increased by the current rate of VAT, the eco-participation* (French recycling tax) or environmental contribution**, as appropriate, and transport costs applicable on the date of the order.

TG&C SAS is entitled to alter its pricelist at any time with a 30 days' notice. Where the price must be altered between registration of the order and delivery, TG&C undertakes to inform the purchaser.

Packaging and presentation referred to in this pricelist are for information only. We reserve the right to alter packaging and presentation units according to our products. Any specific packaging or presentation will be invoiced additionally.

7. REBATES & DISCOUNTS:

Prices in the pricelist are gross. Trade retailers, installers and retailers benefit from a regular discount confirmed by a special terms letter and agreement, this trade discount, taking account of the purchaser's payment for certain services.

There will no discount for early payment.

8.INTERNET:

Should the Purchaser distribute or present TG&C products on the Internet, these activities must be carried out within the strict scope of application of these GTCS and comply with the charters for the distribution of TG&C products on the Internet, which TG&C shall supply to the Purchaser on request. In consequence, the Purchaser undertakes to inform TG&C of all sales of its products on the Internet. A special agreement allowing a purchaser to sell TG&C to a third party doing online distribution will have to be signed.

All promotional operation online for all TG&C products need to be approved by TG&C SAS.

9. PAYMENT TERMS:

(Articles L.441-6 and D.441-5 of the French Commercial Code, French law no. 2001-420 of 15/05/2001 and European Directive no. 2000/35 EC of 29/06/2000).

Initial orders are payable in advance on pro-forma or COD by SEPA bank credit transfer or wire transfer. After the opening of an account confirmed by our financial department, our invoices are payable at 30 days from the end of the month by SEPA direct debit or magnetic direct bill of exchange.

In the event of default in full or partial payment for goods after the due date stated on the invoice, the purchaser shall pay TG&C default interest of 3 times the official interest rate. The official interest rate concerned is that in force on the date of default. This penalty is based on the total, including VAT, of the outstanding sum and runs from the due date for the price without the need for any prior formal notice to pay. In the event of delay in payment, in addition to default interest,

fixed recovery compensation of €40 will be applied. If these costs exceed €40, they may be invoiced on production of supporting documents.

10.TERMINATION:

We formally reserve the right to terminate order agreements in the event of non-payment, even of a single instalment, whatever the impediment or grounds therefor, without such termination preventing TG&C from making a claim under its reservation of ownership clause.

11. RESERVATION OF OWNERSHIP:

Pursuant to the French law of 25/01/1985, as amended by the law of 01/07/1996, TELLIER S.A.S. retains the ownership of the goods sold until full payment of the price, in principal and incidentals. If the purchaser is in receivership or compulsory liquidation, TG&C S.A.S. reserves the right to claim the goods sold and unpaid for, in the collective procedure. As an essential and determining condition of these General Terms and Conditions of Sale, all sales of products to the Purchaser are subject to a retention of title

clause. In consequence, the products delivered shall remain the property of TG&C SAS until payment in full of the whole price and of any incidental items. Failure to make payment on any of the due dates may lead to the goods being reclaimed. The term "payment" is understood to mean the effective receipt by TG&C all sums due.

12. RETURN OF GOODS:

No return is accepted without the prior agreement in writing of TG&C S.A.S. Return requests must be made in writing. No return is accepted carriage due. To be accepted, any merchandise returned must:

- be in its original packaging.
- not have been used.
- be in perfect condition.
- include all the documents provided (notices, etc.).

The costs of return transport are payable by the client. Special orders are not taken back. Wooden articles (cutting boards, spatulas, etc.) are neither taken back nor exchanged. For any return or repossession at the request of the client, a deduction of 25% is applied for management costs. No reconditioning costs can be considered, whatever the grounds for the return.

13. LEGAL WARRANTIES:

In accordance with the SYNEG professional charter, the availability of spare parts that we foresee for a repairable product manufactured in our factories is 10 years from its launch date. The after-sales service of TG&C SAS makes exploded views of its products available to resellers and users to ensure maintenance of the devices. The After-Sales Service of TG&C SAS makes certain recalibration procedures available for resellers and users, in particular concerning professional scales, thus facilitating the repair of devices by the user or the reseller.

TELLIER GOBEL et Cie SAS products sold new in France are guaranteed against any manufacturing or material defect, on presentation of proof for 2 years from the date of purchase. In the event of a longer period indicated on the packaging, the period mentioned on the leaflet or the packaging prevails.

This warranty excludes fragile items made of wood, ceramic, or glass, as well as household appliances, used in the course of a professional activity. Beyond this period, the products can be repaired in our Argenteuil after-sales service workshop, after an estimate has been drawn up by our after-sales service.

The warranty applies, excluding wear parts such as blade, wheel, etc., or consumables, for normal conditions of use and maintenance. It does not include normal wear and tear of the product. This warranty does not cover any damage resulting from:

- shocks, falls, impacts, overload,
- misuse, negligence, non-compliance with the operating instructions, an error in commissioning, cleaning, and maintenance
- the use of non-compatible spare parts or accessories, or unauthorized modification or repair

It also excludes the following cases:

- overheating, prolonged exposure to flame or vacuum
- interior or exterior stains, discolorations, or scratches
- all accidents related to fire, flood, lightning etc ...
- direct or indirect damage due to a surge from a storm or work on the electrical network
- liquid infiltration on the electrical parts
- immersion of an unsuitable product, entry of dust, insects into the product,
- use of unsuitable water or consumables
- scaling (all scaling must be carried out in accordance with the instructions in the user manual)
- damage or malfunctions specifically due to use with a voltage, an electric frequency not in accordance with those specified on the nameplate.

The non-stick coating of Gobel moulds, without Bisphenol A, is guaranteed for 2 years in professional use against the formation of blisters and detachment, except for use in a bain-marie or in a dishwasher, and for use on a direct flame or temperature above 250 °C. Any product manufactured since January the 1st of 2016 includes traceability of the batch of material used and the date of manufacture. Tinplate moulds and appliances are not guaranteed against rust. They should be wiped dry after cleaning by hand. Aluminium articles are not guaranteed against stains or oxidation resulting from use in a bain-marie or in the dishwasher.

This warranty does not apply to packaging or transportation problems during shipment of the product by its owner and / or reseller. The guarantees for the products of the brands of the company TELLIER GOBEL et Cie SAS do not affect the legal rights enjoyed by any consumer locally (in France legal guarantee of conformity referred to in articles L211-4, L211-5 and L221-12 of the code consumption as well as the legal guarantee against hidden defects referred to in articles 1641 to 1649 of the Civil Code), which cannot be excluded or limited, nor the legal rights towards a distributor from whom a product has been purchased.

TELLIER GOBEL et Cie S.A.S. cannot be held responsible for a poor

description of its products by the distributor.

Modalities:

Any return for exchange or repair under the exercise of the warranty requires the prior written consent of TELLIER GOBEL et Cie S.A.S., and communication by the Sales Administration Department of an after-sales file number and a form to be completed.

To be accepted, any returned merchandise must:

- be in its original packaging,
 - include all the documents provided (instructions ...)
 - the after-sales service file number and the after-sales service return form
- The return transport costs are the responsibility of the customer.

14. TREATMENT OF EEEW (Electric and Electronic Equipment Waste):

provision applicable in Metropolitan France and DOM-TOMs :

Pursuant to Decree no. 2005-829 of 20/07/2005 on EEEW completed by Decree no. 2012 - 617 of 2/05/2012 and Decree no.2014 - 928 of 23/8/2014, TELLIER S.A.S. is registered in the French national register of electric and electronic equipment producers (ADEME).

* «Household» EEEW:

Pursuant to changes in the law, small electric and electronic equipment which may be used by households will be subject to EEEW household legislation from 1/01/2015, including in sales between traders: The order dated 8 October 2014, amending that dated 13 July 2006 in application of article 2 of decree no. 2005-829 of 20 July 2005, concerning the composition of electric and electronic equipment and the elimination of such waste, provides: «Without prejudice to article L. 2224-14 of the French General Code for territorial authorities, electric and electronic equipment waste of commercial, industrial, institutional and other origin which, in type and quantity, is similar to that for household use and the waste from such equipment which may be used both by households and other users coming within a category other categories 5 and 11 of article R. 543-172-II of the French Environment Code until 14 August 2018 and, from 15 August 2018, within a category other than categories 3 and 7 of article R. 543-172-II of the French Environment Code, are considered as household electric and electronic equipment waste, within the meaning of article R. 543-173 of the French Environment Code, as from 1 January 2015.»

The distributor is obliged to repossess any used appliance brought by the user on purchasing new equipment or have it repossessed, without charge. The distributor is also obliged to inform consumers of the management cost of the EEEW, stating the amount of the visible contribution clearly on the sales invoice. EEEW contributions for small equipment appearing on this pricelist correspond to the scale in force with the eco-organisation as at 1/01/2015, which may change during the year. We advise you to take note of any change in the scales and the amounts stated on our invoices. Payment of this eco-contribution by the distributor and user enables the eco-organisation to fund end-of-life EEEW by the user bringing it to a collection point or by collecting it (at the user's expense, for a volume below 500 kg or 2.5 m³).

** «Trade» EEEW:

The collection and recycling of EEEW exclusively for trade use (eg. electric tin openers and grinders) for Tellier S.A.S. is handled by VALORESTOPRO, managed by the Ecologic eco-organisation. Ecologic also deal with all the administrative and regulatory requirements (Waste Monitoring form, destruction certificate, etc.). The custodian of trade end-of-life EEEW – whether retailer, installer or user – is obliged to contact the Ecologic Eco organisation: by Internet at www.e-dechet.com or by telephone on +33 (0) 1 30 57 79 14, to organise its treatment, by the custodian bringing it to an Ecologic collection point or by collecting it (at the custodian's expense, for a volume below 500 kg or 2.5 m³). The distributor is obliged to inform trade users and custodians of EEE, by any appropriate means, of the collection and treatment of EEEW arranged by Tellier S.A.S. (article R. 543-195 III of the French Environment Code). A user or custodian discharging trade EEE, not requiring the collection and treatment arranged, is obliged to provide ADEME and the producer of the EEE with the information required for observation and treatment of this EEEW. (Decree no. 2014-928 of 19 August 2014 - article R. 543-199). The management cost of trade EEEW is met through an environmental contribution shown on this pricelist.

15. FORCE MAJEURE:

Tellier Gobel & Cie SAS shall not be liable for the non- or delayed performance of any of its obligations described in these Sale Terms & Conditions caused by an event of force majeure. For this purpose, force majeure means any external, unforeseeable, and irresistible event within the meaning of article 1148 of the French Civil Code.

16. JURISDICTION:

The contract of sale is governed by French law. All disputes relating to this sale, even in the event of a warranty claim or a plurality of defendants, shall, if the parties are unable to reach an amicable agreement, fall within the exclusive jurisdiction of the court in whose geographical jurisdiction Tellier Gobel & Cie SAS's address for service is located. The dispute shall be brought therefore the Commercial Court of Pontoise (FRANCE).

«	
«Pinetree» fondue stove	169
1,2,3...	
2-bread baking tray	184
2L manual sausage filler	67
3 Chopper set	41
3,5L manual sausage filler	66
8 pieces blade	57
A	
Accessories for dehydrators	151
Adapter for electrical scale	108
Adjustable cake ring	249
Ambidextrous heat resistant glove	122
Amovable deep mould	199
Anti-cut glove	90
Apple corer and wedge cutter	53
Apple corer and wedger cutter	53
Apple peeler	54
Apple scoop	62
Apple wedger	54
Asparagus peeler	49
B	
Bag dispenser	150
Baguette slicer	83
Baking mat	273
Baking sheet	200,237,261
Balloon whisk for egg white	275
Barquette baking tray	182
BBQ potatoes holder	167
Beechwood spatula	91
Beechwood spoon	91
Beveled turner	121
Bird's nest mould	121
Black PVC and stainless steel tongs	142
Blade	30
Blade + pusher	28
Blade and pusher household set	28
Blade bloc for lettuce cutter	34
Blade for Alligator Original N3011/N3011R	41
Blade for apple wedge cutter CAX	53
Blade set - Lettuce cutter	34
blade set with handles - Lemon cutter	53
Blade-pusher kit	29
Blades	39
Blades for french-fries cutter	29
Blades for star-cutter	61
Bottle opener with collector box	130
Bowl scraper	92
Box for cling film and alu	150
Box set of «Canelés Bordelais»-moulds	206
Box set of aspic moulds	205
Box set of baking trays	185
Box set of brioche moulds	189
Box set of icing tips	279,280
Box set of millasson moulds	198
Box set of muffin moulds	218
Box set of nonnettes	257
Box set of pastéis de Nata	240
Box set of pastry icing tips	280,281
Box set of petits-fours moulds	204,239
Box set of rectangles and pusher	253

Box set of savarin moulds	201
Box set of shortbread biscuit rings	246
Box set of single serving cakes	188
Box set of soufflé moulds	202
Box set of tart rings	246
Box set of tartlet moulds	217
Boxes and sets of pastry cutters	286
Brasero	171
Bread knife St. S. base	83
Bread mould	185,225
Bread slicer	83
Bread slicer wooden base	83
Bread slicer wooden base 1st price	83
Brioche mould	189,228
Briochette mould	189,228
BRON mandoline accessories	23
Bronze drawplate Chef in Casa	71
Brush & scraper	161
Buche mould	263
Buns mould	211

C

Cabbage grater	24
Cake cutters	287
Calisson	287
Call bell	132
Can opener	101
Can turning disc	97
Canele bordelais mould	206,211
Cannele bordelais mould	209
Cans press	104
Carriage - French-fries cutter	29
Castor julienne	50
Castor peeler	50
Champagne cap	130
Charlotte mould	219
Château cutter	39
Check holder with marbles	144
Check holder with springs	144
Cheese cutting wires	79
Cheese melter	167
Cheese wedger	78
Chef service tong	94
Cherry stoner huller	54
Chinese «fondue» ladles	169
Chocolate fork	294
Chocolate maker	133
Chopper Alligator Original	41
Chopper Alligator Original with collector	41
Choux pastry set	280
Citrus fruit manual peelers	49
Closed savarin mould	210,211
Coat of mail glove	90
Cocktail Master	130
Coconut craker	58
Coffee maker	133
Cog-wheel for can openers	103
Cold smoker	176
Collector	42
Combined barbecue/reblo-chade	171
Condiment dispenser	153
Conical colander	94
Connection cable	168
Cookie press	294
Coring tool for tomatoes	33
Countertop citrus juicer with handle	127

Courbane ring for can opener	98
Cream whipper	283
Crepe dough spreader scraper	122
Crepe spatula	122
Croissant roller cutter	285
Culinary torch	293
Curl cutter	63
Custard ring	249
Cutting blade for cling film	150
Cutting board rack	89

D

Deco spoon®	61
Deco-pins	63
Decorating set	280,281
Decoration kit with 22 carving tools + whetstone	61
Deep cake pan	209,210
Deep frying basket	121
Dehydrator for fruits and vegetables	151
Dent de loup mould	182,223
Diplomate or Bavaois mould	203,238
Dish warmer	141
Dispenser box	160
Display	299
Display box	90
Display Gobel	298
Doble jigger	129
Domestic apple peeler	54
Dough pusher	182
Dough scraper	284
Drawplate	71
Duck press	68
Duo mousse square	255

E

Easy bake release spray	294
Eclairs baking tray	181
Egg basket	119
Egg cooker	119
Egg cup	139
Egg slicer	81
Egg top cutters	81
Electric chinese fondue appliance	169
Electric food mill	19
Electric juice extractor	127
Electric knife	70
Electric peeler professional	49
Electric rice cooker	119,120
Electric soup warmer	120
Electric steamer	119
Electric system	72
Electrical meat mincer	64
Electronic domestic scale	108
Enhancing kit	97

F

Filling tubes	278
Financier baking sheet	215
Financier mould	210
Fine grater	79
Fine tinned sieve	291
Finger sandwiches - Surprise bread	185
Flat bottom bowl	272
Flat pastry brush	277
Flour sifter	291
Fluted boat-shaped mould	205,239
Fondue set «pinetree»	169

Food mill #2	17
Food mill #3	17
Frame	258
French baguette baking tray	184
French fries scoop	121
French-fries cutter	28
Friand mould	203
fries dripping tray	94
Fruit basket	141
Funnel	294

G

Giant skewer	176
Glass rack	132
Gobel perforated pizza mould with feet	186,225
Gobel Pizza mould	186,225
Graduated measure	272,291
Grid for japanese box	154
Grill stone	173
Gugelhupf mould	203
Guitar wires	78

H

Half tart mould	195
Handfree cheese grater	79
Heart-shaped mould	202
Heavy cake frame	261
Heavy cake frame with removable interior divider	261
High output garlic press	42
Hole shaker	289
Hot sauce dispenser	120
Hydrometer for syrup	112
HYGIENIC STATION HANDS-FREE	159

I

Ice cream cake ring	251
Icing tip «hazelnut»	278
Icing tip «moka»	278
Icing tip «petits-fours»	278
Icing tip «plain»	278,279
Icing tip «Saint Honore»	279
Icing tip «yule-log»	278
IMPERIA Pasta machine accessories	72

J

Japanese box	154
Japanese mandoline accessories	25
Japanese mandoline slicer	24
Japanese mini-boxes in container	153
Japanese tray with grid	94
Japanese vegetable turning	39

K

KALI professional apple peeler and slicer	54
KAYSER cream whipper chargers	283
Knife	70
Knife for Alligator N3011X	42
Knife for electrical meat mincer	64
Knife for manual meat mincer	66

L

Large vegetable peeler	49
Lemon cutter	53
Lemon reamer	128

Lemon squeezer 1/2 slice	127
Lettuce cutter	34
Lever-operated pomegranate and citrus juicer	127
Lid for japanese box	154
Lighter sawdust	176
Loaf pan	187,226
Log squeegee	263
Lyre	79

M

Madeleine baking tray	215
Madeleines	209
Madeleines baking tray	223
Madeleinettes	209
Mandoline	23
Mandoline Vivaldi	23
Mango Blade	57
Mango Pusher	58
Manual knives sharpener	90
Manual lemon juicer	127
Manual meat mincer	65
Masher for cocktail	131
Maxi guitar	77
Maxi guitar holders	77
Measuring cup	291
Measuring pourers	129
Mechanical scale	108
Mechanical timer 60 minutes	114
Medieval «sword» skewer	176
Melon wedger	59
Melon wedger knife	59
Merchandising clip	299
Mesh frying skimmer	93
Mill #10	19
Millasson mould	198,209,210
Mincing knife	42
Mini electronic digital probe thermometer	111
Mini guitar	77
Mini guitar holders	77
Mini oven roasting pan	186
Mini rectangular frying basket	121
Mini-buns baking sheet pan	184
Mini-financiers or Biscuits roses de Reims baking sheet	182,223
Mixing bowl	272
Mixing bowl with base-lid	272
Mixing bowl with Non-slip bottom	272
Motorizable accessories for N7905-E	73
Mould for raviolis	74
Mould support	299
Mousse ring	250
Muffin baking tray	181
Muffin mould	205,210,211,240
Multi-blade scissors	90
Multi-cutters set	41
Multi-purpose tong	142

N

N°12 semi-professional electric mincer	65
N°22 semi-professional electric mincer	65
N°5 semi-professional electric mincer	64
Natural pastry bag	279
Nonnette	252
Note paper holder	144
Nutmeg grater	79

O

Onion slicer	41
Oval mould	210
Oval plain bottom aspic mould	205,239
Oval star bottom aspic mould	205,239

P

Pack 15 professional tart moulds	243
Pack of 15 professional cake moulds	243
Pack of 25 professional cake medium moulds	243
Pack of 50 professional Muffin moulds - Origine	243
Pair of salad servers	277
Paper roll cutter	150
Pasta 150 accessories	73
Pasta drying rack	73
Pasta machine - Atlas 150	69
Pasta machine - electrical	70
Pasta machine - electronical	72
Pasta machine - electrical	72
Pasta machine - Manual	72
Pasta machine - Restaurant model	72
Pasta machine accessories Atlas 150	70
Pastéis de Nata	240
Pastry cutter	286
Pastry cutter with handle	285,286,287
Pastry ring	249
Pastry rolling pin	273
Pastry sheet	268
PE cutting board	85
PE ECO cutting board	87
Peeler (on stand)	47
Peeler (on wall fixation)	45
Peeler (with clamp fixation)	47
Peeling heads	48
PEHD 500 cutting board	86
Pepper mill	139
Perforated custard tart pan with loose bottom	199
Petits-fours moulds	204,239
Pickle slicer	62
Pie weight chain	294
Pineapple Blade	57
Pineapple peeler	57
Pineapple Pusher	57,58
Pineapple Slicing guide	58
Pineapple top and tail cutter	58
Pizza cutter	75
Pizza lifter	75
Pizza peel	88
Plain boat-shaped mould	204,239
Planchetta 2 servings	173
Planchetta 4 people - metal base	173
Planchetta 4 people - wooden base	173
Plane	88
Pocket crumber	143
Pollux peeler	50
Potato masher	20
Potato ricer	20
Potatoes bucket	167
Pourer	129
Precision scale	107
Professional electronical scale	107
Professional electronic scale	107

Professional food mill n°5	18
Professional friesing skimmer	94
Professional mandoline	23
Professional mandoline with protective carriage - 3 & 10 mm	23
Professional mandoline without protective carriage	23
Professional oven mitt	122
Professional spätzle sieve	69
Professional stainless steel ladle	93
Professional whisk	275
Professional egg separator	81
Programmable dehydrator	151
Protective carriage	24
Pusher for french-fries cutter	29
Pusher for lettuce cutter	34
Pusher for stick-slicer	37
Pusher for wedge cutter	53

R

Raclette appliance	168
Raclette appliance - ALPAGE®	166
Raclette appliance - Brézière®	165
Raclette oven + grill	168
Radish decorer	62
Rail of 6 mousse rings	250
Raised reinforced edge with wire cake mould	188,227
Ravioli accessory for N8001 / N8005 / N7994	69
Reblochonade kit	166
Reblochonade-raclette kit	166
Recipe pack	207
Recipes refill 50 pc.	299
Rectangle pusher	253
Rectangular addition tray	143
Rectangular napkin holder	140
Replacement mesh insert	289
Reusable professional piping bag	280
Rilsan lever	103
Roasting pan	186
Rosary mould	198,235
Rotary food mill	17
Round addition tray	143
Round crepe dough spreader	121,122
Round fluted cake mould - loose bottom	199,235
Round pastry cutter	286
Round plain cake mould	198,235
Round pusher	252
Round woven cake coolers	293,294
Rounded biscuit sheet	182
Rounded yule-log mould	263
Rum baba mould	206,209,211,240

S

salad tong	142
Salt mill	139
Sauce dispenser for mass catering	141
Saucepan	168
Sausage stand	68
Sausage filler	67
Savarin or ring mould	201,237
Scraper	284
Screw top	133
Seafood tray stand	140
Semi-professional Electric peeler	49
Semi-professional vacuum sealing machine	149
Set of 2 whisk key-ring	130

Set of 3 sieves	21
Set of 6 cutting boards	87
Set of 6 small Holiday shapes for shortbread cookies	258
Set of cutters	62
Set of funnels	67
Set of knives + pushers	42
Set of sausage funnels	64,67,68
Set of sausage funnels for manual mincer	66
Set of stainless steel square pastry rings and pusher	252
Set of knives + pushers alligator	42
Setting tray & grid	94
Sieve	289
Sieve for electric food mill	19
Sieve for electrical meat mincer	64
Sieve for food mill n°10	19
Sieve for food mill n°5	18
Sieve for manual meat mincer	66
Sieves for food mill n°3	17
Sieves for food mill n°5	18
Silicon basting brush	275
Silicon large spatula	275
Silicon small spatula	275
Silicon spoon-spatula	275
Silicone brush	277
Silk brush wooden handle	277
Single serving soufflé mould	202
Skewer holder	174
Skewer kit for Alpage®	166
Skewers frame	176
Skimmer	93
Small pepper grinder	139
Small salt grinder	139
Small service tong	95
Small SousVide Supreme™ pouches	119
Snacking basket	141
Soda seltzer	130
Sommelier corkscrew	129
Soufflé mould	202
Sous vide foam	112
Spare blades for apple corer and wedger	53
Spare parts kit for can opener	103
Spare wires	79
Spatula	92
Spätzle sieve - domestic model	69
Special «Raclette» knife	167
Spiked roller	285
Spits to dunk chocolate - Chocolate forks	294
Spoon	276,92
Square	252
Square cake mould with fixed bottom	199,236
Square cake mould with loose bottom	199,236
Square pusher	253
St.S. pie crimper	285
St.S. pineapple coring tool	58
St/st dough cutter	284
St/st hygienic station hands-free pedal	159
Stainless steel bread / fruit basket	140
Stainless steel fine tinned sieve	292
Stainless steel tongs	142
Stamped cake	188,227
Stamped cake Obsidian	217

Stamped single serving cake mould	188
Star-Cutter	61
Sticks slicer Lever	37
Sticks slicer pusher	37
Stirrer	131
Strainer stand	292
Strip cutter	37
Support for grill stone	174
Sushi and sashimi tong	95
Swiss roll tin	225

T

Tart frame - Rectangular	247
Tart frame - Square	247
Tart mould	191,192,231,232
Tart ring	246
Tartlet baking tray	182
Tartlet mould	193,194,232
Tatar hat - electric model	169
Tatar hat - model with burner	169
Tea tong infuser	131
Tea, herb and spices infuser	132
Terrine slicer	78
Terrine-press HACCP	68
Thai carving knife	61
The LUTIL Slicer	132
The thousand and one tarts	207
Thermo jug	134
Thermometer	113
Thin skin Pollux peeler	50
Timer 3 functions	114
Toast rack	141
Tomato juicer/Juice extractor	21
Tomato Mozzarella Slicer	33
Tomato sauce mill	20
Tomato sauce mill option	65
Tomato slicer	33
Tomatoes and citrus wedge cutter	33
Tong for grill stones	174
Tong for planchettas	173
Torch head	293
Tortilla wedgers	83
Traditional cheese girolle rotary grater	78
Traditional French cheesecake mould	203,238
Traditional raclette	167
Traditional raclette half-wheels	168
Trigger top	134
Truffle and vegetable slicer	25
Truffles mandoline	25
Truffles slicer	25
Turn'up	62
Turning plate	97
Twister slicer	30
Two way express slicer	24

U

Unit blade cutting for mandoline 15000 / 25000	23
Universal safety hand guard	24
Universal scissors	90

V

Vacuum bags	149
Vacuum sealer bag rolls	149
Vegetable sharpeners	63
Vegetable slicer	37,39

W

Waiter's friends	129
Waiter's 2 steps	130
Wall-mount box holder	160
Water boiler and tap	133
Water oven	119
Watermelon and pumpkin peeler	49
Watermelon wedgers	59
Whetstone	61
Wind protector for planchetta - set of 2	173
Wine bucket holder	140
Wine glass clip support	131
Wire cheese and foie gras slicer with board	78
Wooden cutting board	88
Wooden food masher	292
Wooden toast tongs	277
Working post with wheels	98
Woven friesing skimmer	93

«

«The kitchen » poster	299
-----------------------	-----

1,2,3...

10000	23	123740	235	126440	231
101OCT	25	123750	235	126441	232
10201	24	123760	235	126442	231
10202	23	123770	235	126445	232
1020RT	25	123780	235	126450	231
10210	23	123790	235	126451	232
10211	23	123930	237	126520	231
1030RT	25	124030	237	126522	231
112620	238	124034	237	126530	231
114010	291	124040	237	126532	231
114110	291	124050	237	126540	231
114410	291	124110	236	126542	231
119410	226	124120	236	126550	231
119440	226	124210	236	126620	232
119710	226	124220	236	126622	232
119720	226	124340	237	126630	232
119730	226	124610	238	126632	232
119740	226	124810	235	126640	232
120010	226	124820	235	126642	232
120020	226	124940	233	126650	232
120030	226	124950	233	126710	234
120510	223	124990	233	126810	234
120710	223	125100	237	127010	225
120JB	24	125105	237	127020	225
121010	225	125110	237	127030	225
121020	225	125310	233	127120	225
121650	235	125410	233	127130	225
121660	235	125412	234	129810	240
122130	235	125710	233	130210	239
123010	228	125810	233	130310	239
123020	228	126320	231	134000	225
123030	228	126321	231	134010	225
123040	228	126322	231	135010	225
123050	228	126325	231	15000	23
123320	227	126325	231	151210	238
123330	227	126330	231	154050	237
123610	227	126331	231	154060	237
123620	227	126332	231	164510	223
123630	227	126335	231	164710	223
123640	227	126340	231	164810	223
123650	227	126341	231	167030	223
123660	227	126342	231	185400	239
123670	227	126345	231	191010	239
123680	227	126350	231	191510	239
123690	225	126351	231	192010	239
123701	235	126420	231	192510	239
123702	235	126421	232	193470	232
123705	235	126422	231	193472	232
123710	235	126425	232	193480	232
123720	235	126430	231	193490	232
123730	235	126431	232	193510	239
		126432	231	193520	232
		126435	232		

193530	232	219010	185	223790	198
193540	232	219050	185	223801	193
193550	232	219310	185	223822	193
193560	232	219410	187	223930	201
193570	232	219440	187	224030	201
193572	232	219710	187	224034	201
193580	232	219720	187	224040	201
193590	232	219730	187	224050	201
193610	239	219740	187	224050-PK	207
193620	239	220010	187	224101	199
193630	233	220020	187	224110	199
193640	233	220030	187	224120	199
193650	233	220510	182	224210	199
193660	233	220710	181	224220	199
193670	233	221110	183	224340	201
193680	233	221640	199	224610	203
193710	228	221650	199	224810	199
193720	228	221660	199	224820	199
193730	228	221670	199	225100	200
193740	228	221680	199	225101	200
193750	228	221750	199	225105	200
193760	228	221770	199	225110	200
193770	228	222130	198	225120	200
194020	239	222630	188	225310	195
194030	239	223010	189	225410	195
194040	239	223020	189	225412	195
194050	239	223030	189	225710	195
194060	239	223040	189	225810	196
194070	239	223050	189	226120	191
194110	239	223060	189	226120-PK	207
194120	239	223320	188	226320	191
194130	239	223330	188	226321	192
194140	239	223610	188	226322	191
194150	239	223620	188	226325	192
194370	234	223630	188	226330	191
194470	234	223640	188	226331	192
195010	239	223650	188	226332	191
195330	234	223660	188	226335	192
195510	239	223670	188	226340	191
196010	239	223680	188	226340-PK	207
196510	239	223690	185	226341	192
196511	240	223701	198	226342	191
196515	240	223702	198	226345	192
196516	240	223705	198	226350	191
196517	240	223710	198	226351	192
20638B	23	223720	198	226420	191
20638CHB	23	223730	198	226421	192
20638CHBB	23	223740	198	226422	191
20644B	23	223750	198	226425	192
20660B	23	223760	198	226430	191
210910	185	223760-PK	207	226431	192
210920	202	223770	198	226432	191
212620	202	223780	198	226435	192

226440	191	254060	201	293640	194
226441	192	255130	202	293650	194
226442	191	255230	202	293660	194
226445	192	255610	200	293670	194
226450	191	258130	182	293680	194
226451	192	258230	184	293710	189
226520	191	258320	184	293720	189
226521	192	258321	184	293730	189
226522	191	258330	184	293740	189
226530	191	258430	184	293750	189
226531	192	264510	181	293760	189
226532	191	264710	181	293770	189
226540	191	264810	181	294010	204
226541	192	267030	182	294020	204
226542	191	270171	194	294030	204
226550	191	271011	205	294040	204
226620	192	271641	189	294050	204
226622	192	272710	201	294060	204
226630	192	282520	202	294070	204
226632	192	282540	194	294110	205
226640	192	282550	194	294120	205
226642	192	282560	194	294130	205
226650	192	282570	198	294140	205
226710	196	282580	185	294150	205
226810	197	285201	204	294370	197
226950	193	285400	204	294376	197
227005	186	291010	204	294470	197
227010	186	291510	204	294476	197
227020	186	291870	196	295010	204
227030	186	292010	204	295130	196
227120	186	292510	204	295330	196
227130	186	293030	203	295376	196
227310	193	293250	198	295510	204
227330	193	293270	198	295770	193
227340	193	293280	198	295790	193
227350	193	293290	198	296010	204
227840	195	293470	193	296510	204
227845	195	293472	193	296511	205
228020	203	293480	193	296512	205
228310	182	293490	193	296513	181
229810	206	293510	204	298410	182
230210	205	293520	194	298510	181
230310	205	293530	194	298610	184
231010	186	293540	194	299101	209
231020	186	293550	194	299102	209
234010	185	293560	194	299103	209
235010	185	293570	194	299104	210
235020	185	293572	194	299105	209
235110	202	293580	194	299106	210
25000	23	293590	194	299107	210
251210	203	293610	204	299108	209
252660	199	293620	204	299109	209
254050	201	293630	194	299110	210

299130	209	426340	217	814590	267
299201	210	426350	217	814595	267
299202	210	426431	218	815210	278
299203	210	426440	217	815220	279
299204	211	426441	218	815230	279
299205	211	426451	218	815310	278
299206	211	426810	217	815410	278
299220	211	4500CLR	39	815420	278
299230	211	454050	218	815510	278
300RP	79	458320	215	815610	278
30300	24	458321	215	815810	278
30400	24	464510	215	815850	279
305253	299	464710	215	817930	263
305254	299	464810	215	817931	263
305255	299	470171	217	817932	263
305256	299	493740	218	817933	263
305257	299	496512	218	824910	246
305258	299	5013	168	824920	246
307130	298	5029	168	824930	246
307131	298	614530	267	824940	246
307132	298	614580	267	824941	246
307136	298	614590	267	824942	246
307138	298	615530	268	824943	246
307139	189	615535	268	824944	246
307140	298	615580	268	824945	246
307146	299	615590	268	824950	246
308730	279	64JB	24	824960	246
313110	279	703SF1	83	824970	246
313120	279	703SF1P	83	824980	246
313130	279	703SX	83	824990	246
313140	279	714510	267	824992	246
313160	279	714530	267	824994	246
317020	277	714560	267	825150	261
317030	277	714590	267	825160	261
317040	277	714595	267	834910	246
317050	277	722630	188	834920	246
317310	292	726630	188	834930	246
317910	284	729510	206	834940	246
317920	284	729520	206	834941	246
319110	182	729530	206	834942	246
35CPX	83	729540	206	834943	246
4030CLR	39	800710	263	834944	246
4100CLR	39	803CHP1	141	834950	246
412620	219	803CHP2	141	834960	246
420710	215	803CHP3	141	834970	246
423040	218	813710	299	834980	246
423320	217	813850	249	834990	246
423730	218	814410	292	834992	246
423750	218	814550	267	834994	246
423760	218	814560	267	834995	246
425410	217	814565	267	835530	247
426320	217	814570	263	835540	247
426330	217	814580	263	835550	247

835560	247	863510	255	865560	247
844910	286	863540	255	865680	251
844920	286	863790	255	865690	251
844930	286	864180	255	866004	252
844940	286	864330	253	866005	252
844950	286	864350	253	866010	252
844960	286	864370	253	866020	252
844970	286	864390	253	866030	252
844980	286	864840	252	866040	252
845010	286	864904	251	866050	252
845020	286	864905	251	866060	252
845030	286	864910	251	866260	249
845040	286	864920	251	866280	249
845050	286	864930	251	866320	250
845060	286	864940	251	866330	250
845070	286	864950	251	866340	250
845080	286	864960	251	866350	250
845090	286	864970	251	866360	250
845130	286	864980	251	866370	250
845140	286	864990	251	866420	249
845150	286	865000	249	866440	249
845160	286	865001	249	866460	249
845170	287	865003	249	866480	249
845180	287	865004	249	866510	255
845200	287	865010	250	866600	252
8485FI	25	865011	250	866610	252
8485JAPGN	24	865012	250	866630	252
8485LA	25	865020	250	866632	252
8485MO	25	865030	250	866640	252
8486FI	25	865040	250	866650	252
8486JAPP	24	865050	250	866660	252
8486LA	25	865060	250	866740	253
8486MO	25	865070	250	866750	253
8490JAPP	24	865080	250	866755	253
860430	255	865090	250	867010	255
862740	255	865092	250	867360	253
862750	255	865102	249	867420	252
862760	255	865104	249	867430	252
863010	256	865105	249	867505	253
863020	256	865110	249	867510	253
863050	256	865120	249	867530	253
863070	256	865130	249	867540	253
863110	256	865140	249	867560	253
863260	256	865150	249	867740	253
863310	252	865160	249	867760	253
863320	252	865170	249	868010	255
863322	252	865180	249	868110	255
863330	252	865190	249	868510	256
863340	252	865310	247	868610	255
863350	252	865320	247	868630	256
863360	252	865530	247	868640	256
863370	252	865540	247	868660	256
863410	255	865550	247	868680	256

868710	255	884002	258	884201	287
868730	255	884004	258	884202	287
868810	257	884005	259	884420	254
869005	252	884007	258	884421	254
869010	252	884008	258	884422	254
869030	252	884009	259	884423	254
869110	255	884012	257	884424	254
869130	255	884013	257	884425	254
869230	255	884015	257	884426	254
869330	255	884017	256	884427	254
869530	256	884018	256	884428	254
869610	256	884019	257	884429	254
869630	256	884021	257	884430	254
869730	256	884023	256	884431	254
871220	252	884027	260	884432	254
873220	259	884028	260	884433	254
875910	253	884029	260	884434	254
877310	257	884030	260	884435	254
877630	253	884031	257	884436	254
877821	250	884032	256	884437	254
880001	286	884034	257	884438	254
880101	286	884035	257	884439	254
881780	253	884042	287	884501	259
883901	256	884043	287	884502	260
883902	256	884048	255	884641	254
883903	256	884049	255	884642	254
883907	257	884101	257	884643	254
883908	259	884104	257	884644	254
883909	259	884105	257	884645	254
883910	259	884106	257	884646	254
883918	259	884107	260	884647	254
883920	260	884108	258	884648	254
883921	260	884110	258	884649	254
883922	260	884111	258	884650	254
883923	260	884115	258	884651	254
883924	260	884120	258	884652	254
883925	260	884121	258	884653	254
883926	260	884122	259	884654	254
883927	260	884123	259	884655	254
883928	260	884124	259	884656	254
883929	260	884125	258	884657	254
883930	260	884127	259	884658	254
883933	260	884128	258	884659	254
883934	260	884129	257	884660	254
883942	260	884130	258	884661	254
883943	259	884131	259	884662	254
883944	259	884132	259	884663	254
883945	260	884139	256	884664	254
883946	259	884141	258	884665	254
883948	255	884142	258	884666	254
883953	260	884144	259	884709	260
883972	256	884145	258	884711	260
884001	259	884154	258	884712	259

CP06	27
CP08	27
CP10	27
CP13	27
CS00	27
CS06	27
CS08	27
CS10	27
CS13	27
CSA	34
CSA01	34
CSA02	34
CSAL	34
CSAL01	34
CSAL02	34
CSAM	34
CSAM01	34
CSAM02	34
CSP10	28
CT-MZ	33
CT3X	20
CT3X-EL	20
CTE00	61
CTE01	61
CTER01	78
CTER02	78
CTX	
CTX40	33
CTXM55	33
CX00	27
CX00-P	28
CX06	27
CX06-P	28
CX08	27
CX08-P	28
CX10	27
CX10-P	28
CX13	27
CX13-P	28

D

DF030	150
DF045	150
DFV300	150
DFV450	150
DO1250	291
DO251	130
DO956	129
DP000	150
DP212-J	129
DP213-V	129
DP214-B	129
DP215	129

E

E0010.	48
E0011.	48
E0012.	48
E0019.	48
EA-EL	57
EA.	57
EA001	57
EA002	57
EA003	57
EA004	57
EA005	57
EA006	57
EA007	57
EA008	57
EA009	57
EA010	58
EA013	57
EA014	58
EA095	57
EA102	57
EM001.	45
EM002.	45
EM003.	46
EM004	46
EMX001	45
EMX002	45
EMX003	45
EMX004	45
EP001.	47
EP002.	47
EP003.	47
EP004.	47
EPX001.	46
EPX002.	46
EPX003.	46
EPX004	46
ESJX001	47
ESJX002	47
ESJX003	48
ESJX004	48
EX5010	19
EX5015	19
EX5020	19
EX5030	19
EX5040	19
EX5M100	19
EX5M130	19
EX5T100	19
EX5T130	19

F

FAF	176
-----	-----

FAF01	176
FAFR	176
FVX1	83

G

GAN13	122
GB20P009	273
GL19P001	243
GL19P004	243
GL19P005	243
GL19P006	243
GL19P010	299
GL19P011	293
GL19P013	275
GL19P014	275
GL19P015	275
GL19P016	275
GL19P017	294
GL20P003	272
GL20P004	272
GL20P005	272
GL20P011	207
GL303	272
GL304	273
GL305	273
GL306	273
GL307	276
GL308	276
GL309	276
GL310	277
GL311	277
GL312	272
GL313	272
GL314	272
GL315	272
GL316	272
GL317	272
GL318	272
GL319	272
GL320	272
GL321	280
GL322	280
GL323	280
GL324	280
GL325	280
GL326	276
GL327	276
GL328	276
GL329	272
GX01	77
GX012	77
GX014	77
GX015-2	78

GX02	77	LT2104	93	N3011R	41
GX022	77	LT2105	93	N3011S	41
GX024	77	LT2106	93	N3011T	41
GX03	77	LT2107	93	N3011X-03	42
GX04	77	LT2108	93	N3011X-06	42
GX052	77	LT2109	93	N3011X-09K	42
GX053	77	LT2110	93	N3011X-12	42
GXM012	77	LT2111	93	N3011XK	42
GXM015-2	78	LT2112	94	N3020	292
GXM022	77	LT2113	94	N3023-09	28
GXM03	77	LT2114	94	N3023-12	28
GXM04	77	LT2115	94	N3023VLT	28
GXM05	77	LT2116	94	N3024	20
GXM052	77	LT2117	142	N3025	20
GXM053	77	LT2118	142	N3027	78
GXM06	77	LT2119	142	N3028	20
H		LT2120	93	N3031	21
HV12-EL	65	LT2121	93	N3032	21
HV1222-OPTCT	65	LT2122	93	N3040	151
HV22-EL	65	LT2123	93	N3040-F	151
HV5-EL	64	LT2124	93	N3040-P	151
HV5-OPTCT	65	LT2125	93	N3042	151
I		LT2126	93	N3042-F	151
ID1000	61	LT2127	142	N3042-P	151
ID1100	63	LT2128	142	N3066	142
ID1101	63	LT2129	142	N3067	142
ID1205	62	LT2130	142	N3068	142
ID1207	62	LT2131	88	N3069	142
ID2500	61	LT21P001	90	N3072	142
ID2580	61	LT21P002	90	N3073	142
ID4006	49	LT21P003	90	N3074	142
ID4007	49	LT21P004	90	N3078	33
ID4036	63	M		N3079	49
ID4100	62	M500	18	N3082	130
ID5000	294	M5010	18	N3087R	122
ID5001	294	M5015	18	N3087RL	122
ID5002	294	M5020	18	N3091	90
ID5003	294	M5030	18	N3092	90
ID5004	294	M5040	18	N3100	112
K		M510	18	N3109	112
KRFA01	79	M515	18	N3110	112
L		M520	18	N3111	112
LT19P001	143	M530	18	N3113	113
LT19P002	143	M540	18	N3114	113
LT20A009	28	MLT.	39	N3115	113
LT20P002	140	MLT01.	39	N3116	113
LT20P003	140	N		N3117	113
LT20P004	140	N3004X	17	N3118	112
LT2101	88	N3011	41	N3119	111
LT2102	93	N3011-B	42	N3120	113
LT2103	93	N3011-BX	42	N3121	113
		N3011-C	41	N3122	111
				N3123	111

N3124	111	N3993	94	N4184X	81
N3124C	111	N3995	94	N4185	54
N3127	111	N40204C	66	N4188X	81
N3236	42	N40206C	66	N4190	79
N3422	90	N40208C	66	N4197	62
N3500	79	N40212C	66	N4200	58
N3503	79	N40215C	66	N4206	54
N35031	79	N40221C	66	N4207	54
N3504	79	N4022C	65	N4210	58
N35041	79	N4022C-S	66	N4212	58
N3506	78	N40304C	66	N4214	59
N35061	78	N40306C	66	N4215	59
N3515	79	N40308C	66	N4220	49
N3665	107	N40312C	66	N4221	49
N3670-A	108	N40315C	66	N4225	49
N3671	107	N40321C	66	N4230	54
N3672	107	N4032C	65	N4231	54
N3673	107	N4032C-S	66	N4232T	54
N3681	107	N4039X	94	N4233	54
N3682	107	N4041	103	N4298	42
N3684	107	N4043-ID	121	N4312	129
N3685	107	N4043-IDG	121	N4313	129
N3686	107	N4047C	67	N4319	130
N3690	108	N4047CXE	67	N4390C	154
N3691	108	N4054	130	N4390T	154
N3692	108	N4055X	130	N4391C	154
N3693	107	N4056	104	N4391G	154
N3693-A	108	N4057	104	N4391T	154
N3694	107	N4074	130	N4392C	154
N3695	108	N4075X	130	N4392G	154
N3696	108	N4083X	283	N4392T	154
N3697	107	N4084X	283	N4401	153
N3697-A	108	N4086X	283	N4403	153
N3702	75	N4087X	283	N4404	153
N3703	284	N4097	127	N4408	153
N37031	284	N4098	127	N4409	153
N37032	284	N4105	127	N4410	153
N3705	289	N4107	128	N4411	153
N3707	289	N4110	141	N4412	153
N3711	291	N4120	127	N4413	153
N3715	294	N4120-24P	127	N4504	167
N3716	287	N4134	131	N4905	133
N3720	273	N4135	129	N5069	133
N3725	284	N4136	131	N5069-B	133
N3726	285	N4140	131	N5070	133
N3728	285	N4142-20	131	N5071	133
N3728-2	285	N4150	139	N5072	133
N3730	284	N4151	139	N5072-B	134
N3731	284	N4153	139	N5076	134
N3738	284	N4154	139	N5077	134
N3740	131	N4155	139	N5078	134
N3924	293	N4183	81	N5084	134
N3992	94	N4184	81	N5085	134

N5088	134	N7917-05	71	NC008	293
N5089	134	N7917-06	71	NC009	293
N5308	133	N7917-07	71	NC010	93
N5312	133	N7917-08	71	NC012	289
N5316	133	N7917-09	71	NC013	289
N5400	121	N7917-10	71	NC014	289
N5600	64	N7917-11	71	NC015	289
N5600-03	64	N7917-12	71	NC016	89
N5600-06	64	N7917-13	71	NC018D	132
N5600-07	64	N7917-14	71	NC019	121
N5600-08	64	N7917-15	71	NC020	140
N5600-C	64	N7917-16	71	NC020-C	140
N5600-S	64	N7919	294	NC024	140
N5700	67	N7932	72	NC027	293
N5700-S	67	N7933	72	NC028	293
N5750	67	N8001	69	NC036	139
N5750-S	68	N8001-E	69	NC052	174
N5900	66	N8003	70	NC057	93
N7004	83	N8004	69	NC061	141
N7010	24	N8005	69	NC070	275
N7013	83	N8006	69	NC071	275
N7105V	63	N8008	62	NC072	275
N7900	72	N8012	50	NC073	275
N7900-01	72	N8013	50	NC074	275
N7900-02	72	N8014	50	NC075	275
N7900-03	72	N8015	50	NC076	275
N7900-04	72	N8019	104	NC077	275
N7900-05	72	N8028	144	NC1011460	93
N7900-06	72	N8029	144	NC1011660	93
N7900-07	72	N8030	144	NC1012860	93
N7905	72	N8031	144	NC1017260	94
N7905-01	73	N8033	144	NC1018160	121
N7905-02	73	N8040	132	NC1043960	121
N7905-03	73	N8060	120	NC1053860	293
N7905-04	73	N8090	119	NC1053960	293
N7905-05	73	N8091	133	NC1054060	294
N7905-06	73	N8093	119	NC3016050	141
N7905-07	73	N8093-P	119	NC4250060	174
N7905-08	73	N8094	119	NC4250460	174
N7905-11	73	N8110	119	NC5020760	294
N7905-E	72	N8201	112	NC5060760	289
N7905R	72	N8900	120	NC5061760	289
N7906	72	N9200	131	NC5062860	289
N7907	73	N9201	132	NC5064660	289
N7910	74	N9202	132	NC5064760	289
N7911	74	NBR01	161	NC5065660	289
N7912	74	NBR02	161	NC5065760	289
N7913	74	NC001	93	NC7020160	141
N7917	70	NC003	93	NC8090660	169
N7917-01	70	NC004	93	NCS011	273
N7917-02	70	NC005	93	NCS301	273
N7917-03	71	NC006	68	NCS601	273
N7917-04	71	NC007	293	NDS301	120

NDS500	141	NPP8-B	87	NV010	149
NK001	283	NPP8-R	87	NV011	149
NK002	283	NPP8-V	87	NV012	149
NK003	283	NPP9	86	NV013	149
NM20-1	91	NPP9-B	87	NV014	149
NM25-1	91	NPP9-J	87	NV015	149
NM30-1	91	NPP9-R	87	NV400	149
NM35-1	91	NPP9-V	87	NVS010	119
NM40-1	91	NPPC	87	NVS020	119
NMB25-1	92	NPPL28	88	NVS030	119
NMPA30	92	NPPL40	88	NY100	68
NMPA40	92	NPPL45	88	NY300	68
NMPA45	92	NPPR	88		
NP20-1	277	NPPR01	88	O	
NP25-1	277	NPPR1	88	O2820-2	103
NP30-1	277	NPS22	277	O2830-5	98
NP35-1	277	NPX30	75	O2870-5	103
NP40-1	277	NPX31	75	O2873-5	98
NPB07	87	NRC01-1	121	O2895	103
NPB28	75	NRC01X	122	O2P55	102
NPB33	75	NRC02-1	122	O2V55	102
NPB40	75	NRC03-1	122	O3870-5	103
NPP11-J	86	NRP43	273	O3895	103
NPP11-N	85	NRP47	273	O3P40	102
NPP11-R	86	NRP50	273	O3V40	102
NPP11-V	86	NRPP45	273	O5P55	102
NPP14	86	NRPP50	273	O5V55	102
NPP2	85	NS007	272	OBSXP55	101
NPP4	85	NS008	291	OBSXV55	101
NPP4-B	86	NSP025-1	91	OE7502	97
NPP4-J	86	NSP030-1	91	OE750M	97
NPP4-M	85	NSP035-1	91	OE750M-110	97
NPP4-R	86	NSP040-1	91	OE750T	97
NPP4-V	86	NSP050	91	OE750X	97
NPP41	85	NSP060	91	OE7553	98
NPP5	85	NSP080	91	OE7554-2	98
NPP5-B	86	NSP100	91	OE7620-B	97
NPP5-J	86	NSP120	91	OE7620.	97
NPP5-R	86	NSPA25	92	OE896	97
NPP5-V	86	NSPA30	92	OEX821	98
NPP51	85	NSPA35	92	OEXTC	97
NPP51-M	86	NSPA40	92	OX5P55	101
NPP6	85	NSPA45	92	OX5V55	101
NPP6-B	86	NSPA50	92	OXV55	101
NPP6-J	86	NSPB25-1	91		
NPP6-M	85	NSPB30-1	91	P	
NPP6-P	85	NSPB35-1	91	P1000	19
NPP6-R	86	NSPB40-1	91	P10010	19
NPP6-V	86	NSPS28	92	P10015	19
NPP61	85	NSPS29	92	P10020	19
NPP61-M	86	NSPS31	92	P10030	19
NPP7	86	NSPT100	92	P10040	19
NPP8	86	NSPT120	92	P1010	19

P1015	19
P1020	19
P1030	19
P1040	19
PAP3	285
PAP4	94
PAP5	95
PAP6	95
PB1	299
PB2	299
PBC06C	175
PF01	78
PFO6	78
PFO8	78
PIER-P	174
PIERO1	173
PIERO3	173
PIER17	174
PIER25	174
PLAN-P	173
PLAN-PV	173
PLAN01	173
PLAN02	173
PLAN05	173
PLU03M	61
POBE01	175
POBE02	175
POBN01†	174
POBN01V	174
POBX01	175
POBX01-S	175
POBX01V	175
POBX4C	175
POBX4D	175
PORT01	176
PORT02	176
PRESTE01	68
PSX05	67
PSX08	67
PTX21	98

R

RACL01	165
RACL01BA	166
RACL01NX	166
RACL02	165
RACL02C	165
RACL03	165
RACP01NX	168
RAM	143
REB01	166
REB02	166
REB03	166

RECH02	169
RECH02-KIT	169

S

S2	17
S3	17
S3015	17
S3025	17
S3040	17
SEP-OC	167
SEP-R	167
SEP-RC	167
SHMX	159
SHPX	159
SM006	59
SM008	59
SM01	59
SM06	59
SM08	59
SMPO4	59
SMPO6	59
SMP08	59
SPO1	69
SPOE01	81
SUP01	174
SUP03	174

T

TAS	132
TAT	24
TBCOU01-N	129
TBCOU02-R	129
TORT06	83
TORT08	83
TR10	58
TTM02-PB	168
TTM03	167
TTM05	167
TTM05C-110	167
TTM10	167
TTM10C-110	167
TTM20	168
TTM30	168
TTM40CE	168
TTM80AL	169
TTM80E	169
TTMFC01	169
TU01	62
TU02	62
TU03	62

U

UMD01	114
UMM01	114

UTD01	111
-------	-----

X

X3-F	17
X3015	17
X3025	17
X3040	17
X500	18
X5010	18
X5015	18
X5020	18
X5030	18
X5040	18
X510	18
X515	18
X520	18
X530	18
X540	18

